

SIEMENS

SIMATIC HMI

HMI device MP 277 (WinCC flexible)

Operating Instructions

Order No. 6AV6691-1DJ01-0AB0

03/2009
A5E02479740-01

| | |
|-----------------------------------|----|
| Preface | |
| Overview | 1 |
| Safety instructions and approvals | 2 |
| Planning application | 3 |
| Mounting and connecting | 4 |
| Operator controls and displays | 5 |
| Configuring the operating system | 6 |
| Commissioning a project | 7 |
| Operating a project | 8 |
| Operating alarms | 9 |
| Operating recipes | 10 |
| Maintenance and care | 11 |
| Technical specifications | 12 |
| Appendix | A |
| Abbreviations | B |

Legal information

Warning notice system

This manual contains notices you have to observe in order to ensure your personal safety, as well as to prevent damage to property. The notices referring to your personal safety are highlighted in the manual by a safety alert symbol, notices referring only to property damage have no safety alert symbol. These notices shown below are graded according to the degree of danger.

| |
|--|
| ⚠ DANGER |
| indicates that death or severe personal injury will result if proper precautions are not taken. |
| ⚠ WARNING |
| indicates that death or severe personal injury may result if proper precautions are not taken. |
| ⚠ CAUTION |
| with a safety alert symbol, indicates that minor personal injury can result if proper precautions are not taken. |
| CAUTION |
| without a safety alert symbol, indicates that property damage can result if proper precautions are not taken. |
| NOTICE |
| indicates that an unintended result or situation can occur if the corresponding information is not taken into account. |

If more than one degree of danger is present, the warning notice representing the highest degree of danger will be used. A notice warning of injury to persons with a safety alert symbol may also include a warning relating to property damage.

Qualified Personnel

The device/system may only be set up and used in conjunction with this documentation. Commissioning and operation of a device/system may only be performed by **qualified personnel**. Within the context of the safety notes in this documentation qualified persons are defined as persons who are authorized to commission, ground and label devices, systems and circuits in accordance with established safety practices and standards.

Proper use of Siemens products

Note the following:

| |
|---|
| ⚠ WARNING |
| Siemens products may only be used for the applications described in the catalog and in the relevant technical documentation. If products and components from other manufacturers are used, these must be recommended or approved by Siemens. Proper transport, storage, installation, assembly, commissioning, operation and maintenance are required to ensure that the products operate safely and without any problems. The permissible ambient conditions must be adhered to. The information in the relevant documentation must be observed. |

Trademarks

All names identified by ® are registered trademarks of the Siemens AG. The remaining trademarks in this publication may be trademarks whose use by third parties for their own purposes could violate the rights of the owner.

Disclaimer of Liability

We have reviewed the contents of this publication to ensure consistency with the hardware and software described. Since variance cannot be precluded entirely, we cannot guarantee full consistency. However, the information in this publication is reviewed regularly and any necessary corrections are included in subsequent editions.

Preface

Purpose of the operating instructions

These operating instructions provide information for manuals derived from the requirements for mechanical engineering documentation according to DIN EN 62079. This information relates to the place of use, transport, storage, mounting, use and maintenance.

These operating instructions are intended for:

- Users
- Commissioning engineers
- Maintenance personnel

Pay particular attention to the section "Safety Instructions (Page 31)".

The help integrated in WinCC flexible, the WinCC flexible Information System, contains detailed information. The information system contains instructions, examples and reference information in electronic form.

Required knowledge

General knowledge of automation technology and process communication is needed to understand the operating instructions.

It is also assumed that those using the operating instructions have experience with personal computers and knowledge of Microsoft operating systems.

Scope of the operating instructions

The operating instructions apply to the HMI device MP 277 in conjunction with the software package WinCC flexible.

Position in the information landscape

These operating instructions form part of the SIMATIC HMI documentation. You can obtain an overview of SIMATIC hardware and SIMATIC software products and SIMATIC systems and information that can be called up in PDF format in various languages at the following address:

["http://www.automation.siemens.com/simatic/portal/html_76/techdoku.htm"](http://www.automation.siemens.com/simatic/portal/html_76/techdoku.htm)

Conventions

The following text notation will facilitate reading this manual:

| Notation | Scope |
|---------------|--|
| "Add screen" | <ul style="list-style-type: none">• Terminology that appears in the user interface, for example dialog names, tabs, buttons, menu commands• Required input, for example, limits, tag values.• Path information |
| "File > Edit" | Operational sequences, for example, menu commands, shortcut menu commands. |
| <F1>, <Alt+P> | Keyboard operation |

Please observe notes labeled as follows:

Note

A note contains important information about the product and its use or a specific section of the manual to which you should pay particular attention.

Illustrations in this manual

This manual contains illustrations of the described devices. The illustrations may differ from devices actually delivered.

Trademarks

The following designations marked with the symbol ® are registered trademarks of Siemens AG:

- HMI®
- SIMATIC®
- WinCC®
- SIMATIC MP 277®

Additional information

You can find additional information about products described in the manual under "Contact" in the following table:

| Request | Contact |
|--------------------------------------|---|
| Contact persons and office locations | "http://www.siemens.com/automation/partner" |
| Additional technical documentation | "http://www.automation.siemens.com/portal/index.htm" |
| Training Center | "http://sitrain.automation.siemens.com/sitrain/" |
| Technical Support | "http://support.automation.siemens.com" |
| Online support request form | "http://www.siemens.com/automation/support-request" |
| Service | "http://www.siemens.com/automation/service" |

Recycling and disposal

The HMI devices described in these operating instructions can be recycled due to the low levels of pollutants. Contact a certified disposal service company for environmentally sound recycling and disposal of your old devices.

Table of contents

| | | |
|----------|---|-----------|
| | Preface | 3 |
| 1 | Overview..... | 13 |
| 1.1 | Product overview | 13 |
| 1.2 | Design of the HMI Device MP 277 8" Touch | 14 |
| 1.3 | Design of the HMI Device MP 277 8" Key | 16 |
| 1.4 | Design of the HMI Device MP 277 10" Touch | 18 |
| 1.5 | Design of the HMI Device MP 277 10" Key | 20 |
| 1.6 | Accessory kit | 22 |
| 1.7 | Accessories..... | 23 |
| 1.8 | The HMI device in the operating process | 25 |
| 1.9 | Functional Scope with WinCC flexible | 26 |
| 1.10 | Software options | 28 |
| 1.11 | Communications | 29 |
| 2 | Safety instructions and approvals | 31 |
| 2.1 | Safety Instructions | 31 |
| 2.2 | Standards, certificates and approvals..... | 32 |
| 2.3 | Notes about usage..... | 34 |
| 2.4 | Electromagnetic compatibility | 35 |
| 2.5 | Transport and storage conditions | 37 |
| 3 | Planning application..... | 39 |
| 3.1 | Notes about usage..... | 39 |
| 3.2 | Mounting positions | 41 |
| 3.3 | Preparing for Mounting | 42 |
| 3.4 | Specifications for Insulation Tests, Protection Class and Degree of Protection..... | 44 |
| 3.5 | Rated voltages | 44 |
| 4 | Mounting and connecting..... | 45 |
| 4.1 | Checking the package contents..... | 45 |
| 4.2 | Mounting the HMI Device..... | 46 |
| 4.3 | Connecting the HMI device..... | 49 |
| 4.3.1 | Overview | 49 |
| 4.3.2 | Ports..... | 50 |
| 4.3.3 | Connecting the equipotential bonding circuit..... | 51 |
| 4.3.4 | Connecting the Power Supply..... | 53 |
| 4.3.5 | Connecting the PLC..... | 55 |
| 4.3.6 | Connecting a Configuring PC | 58 |

| | | |
|----------|--|-----------|
| 4.3.7 | Connecting a USB device | 61 |
| 4.3.8 | Connecting a Printer | 62 |
| 4.4 | Switching on and Testing the HMI device..... | 63 |
| 4.5 | Securing the cables..... | 64 |
| 5 | Operator controls and displays | 65 |
| 5.1 | Front operator controls..... | 65 |
| 5.2 | Using Memory Cards with the HMI Device | 67 |
| 5.3 | Labeling the Function Keys at the MP 277 Key..... | 69 |
| 6 | Configuring the operating system | 73 |
| 6.1 | Loader | 73 |
| 6.2 | Setting up and disabling SecureMode | 77 |
| 6.3 | Control Panel | 78 |
| 6.3.1 | Overview | 78 |
| 6.3.2 | Reference for functions..... | 79 |
| 6.3.3 | Operating the Control Panel | 81 |
| 6.3.3.1 | Overview | 81 |
| 6.3.3.2 | Input with the Touch Screen | 82 |
| 6.3.3.3 | Input with the Keyboard | 84 |
| 6.4 | Changing settings for operation | 88 |
| 6.4.1 | Configuring the Screen Keyboard..... | 88 |
| 6.4.2 | Setting the Character Repetition of the Keyboard | 89 |
| 6.4.3 | Setting the Double-click | 91 |
| 6.4.4 | Calibrating the Touch Screen | 92 |
| 6.5 | Changing Password Protection..... | 94 |
| 6.6 | Changing HMI device settings | 95 |
| 6.6.1 | Setting the Date and Time | 95 |
| 6.6.2 | Changing Regional Settings | 97 |
| 6.6.3 | Backing up Registry Information | 98 |
| 6.6.4 | Changing monitor settings | 99 |
| 6.6.5 | Setting the screen saver | 100 |
| 6.6.6 | Changing the Printer Properties..... | 102 |
| 6.6.7 | Set the volume | 103 |
| 6.6.8 | Restarting the HMI Device | 105 |
| 6.6.9 | Displaying Information about the HMI Device..... | 106 |
| 6.6.10 | Displaying System Properties | 107 |
| 6.7 | Setting the Delay Time..... | 108 |
| 6.8 | Setting the uninterruptible power supply..... | 109 |
| 6.9 | State of uninterruptible power supply..... | 111 |
| 6.10 | Change the communication settings..... | 112 |
| 6.10.1 | Changing S7 transfer settings..... | 112 |
| 6.10.2 | Configuring the data channel | 115 |
| 6.10.3 | Enabling PROFINET IO | 117 |
| 6.11 | Configuring network operation | 119 |
| 6.11.1 | Overview of network operation | 119 |
| 6.11.2 | Setting the device name of the HMI device | 121 |
| 6.11.3 | Changing the Network Configuration | 122 |

| | | |
|----------|---|------------|
| 6.11.4 | Changing the Logon Data | 124 |
| 6.11.5 | Changing E-Mail Settings | 125 |
| 6.11.6 | Changing internet settings | 126 |
| 6.11.6.1 | Changing General Internet Settings | 126 |
| 6.11.6.2 | Setting the Proxy Server | 127 |
| 6.11.6.3 | Changing Privacy Settings | 128 |
| 6.11.6.4 | Importing and Deleting Certificates | 129 |
| 6.12 | Saving to external storage device (backup)..... | 131 |
| 6.13 | Restoring from external storage device | 133 |
| 6.14 | Activate Memory Management | 136 |
| 7 | Commissioning a project | 137 |
| 7.1 | Overview | 137 |
| 7.2 | Operating modes | 138 |
| 7.3 | Using existing projects | 139 |
| 7.4 | Data Transmission Options..... | 140 |
| 7.5 | Transfer..... | 141 |
| 7.5.1 | Overview | 141 |
| 7.5.2 | Starting manual transfer..... | 141 |
| 7.5.3 | Starting automatic transfer..... | 142 |
| 7.5.4 | Starting backtransfer | 144 |
| 7.5.5 | Testing a project | 145 |
| 7.6 | Backup and restore..... | 146 |
| 7.6.1 | Overview | 146 |
| 7.6.2 | Backup and restore using WinCC flexible | 147 |
| 7.6.3 | Backup and restore using ProSave | 149 |
| 7.7 | Updating the operating system | 151 |
| 7.7.1 | Overview | 151 |
| 7.7.2 | Resetting factory settings..... | 152 |
| 7.7.3 | Updating the Operating System using WinCC flexible | 152 |
| 7.7.4 | Updating the Operating System using ProSave | 154 |
| 7.8 | Installing and removing options | 155 |
| 7.8.1 | Overview | 155 |
| 7.8.2 | Installing and removing options using WinCC flexible..... | 155 |
| 7.8.3 | Installing and removing options using ProSave..... | 157 |
| 7.9 | Transferring and transferring back license keys..... | 158 |
| 7.9.1 | Overview | 158 |
| 7.9.2 | Transferring and transferring back license keys | 159 |
| 8 | Operating a project | 161 |
| 8.1 | Overview | 161 |
| 8.2 | Direct keys | 164 |
| 8.3 | Setting the project language | 165 |
| 8.4 | Entering values using the touch screen..... | 166 |
| 8.4.1 | Overview | 166 |
| 8.4.2 | Entering and Editing Numerical Values | 167 |
| 8.4.3 | Entering and editing alphanumerical values..... | 170 |
| 8.4.4 | Entering the date and time..... | 172 |

| | | |
|----------|---|------------|
| 8.4.5 | Entering Symbolic Values | 172 |
| 8.4.6 | Displaying Infotext | 173 |
| 8.5 | Entering values using the keys | 174 |
| 8.5.1 | Control keys | 174 |
| 8.5.2 | Example: Enter characters using the alphanumeric keyboard | 176 |
| 8.5.3 | Function keys | 177 |
| 8.5.4 | General procedures | 177 |
| 8.5.5 | Entering and editing numerical values | 178 |
| 8.5.6 | Entering and editing alphanumerical values | 179 |
| 8.5.7 | Entering the date and time | 180 |
| 8.5.8 | Entering Symbolic Values | 180 |
| 8.5.9 | Displaying Infotext | 181 |
| 8.6 | Bar and gauge | 182 |
| 8.7 | Operating the switch | 183 |
| 8.8 | Operating the Slider Control | 184 |
| 8.9 | Operating the Trend View | 186 |
| 8.10 | Operating the status force | 188 |
| 8.10.1 | Overview | 188 |
| 8.10.2 | Touch operation | 189 |
| 8.10.3 | Key control | 191 |
| 8.11 | Operating the Sm@rtClient view | 193 |
| 8.11.1 | Overview | 193 |
| 8.11.2 | Touch operation | 194 |
| 8.11.3 | Key control | 195 |
| 8.12 | Project security | 197 |
| 8.12.1 | Overview | 197 |
| 8.12.2 | User view | 198 |
| 8.12.3 | User logon | 200 |
| 8.12.4 | User logoff | 201 |
| 8.12.5 | Creating users | 202 |
| 8.12.5.1 | Creating users with touch operation | 202 |
| 8.12.5.2 | Creating users with key operation | 203 |
| 8.12.6 | Changing user data | 206 |
| 8.12.6.1 | Changing user data with touch operation | 206 |
| 8.12.6.2 | Changing user data with key operation | 207 |
| 8.12.7 | Deleting users | 208 |
| 8.13 | Closing the project | 208 |
| 9 | Operating alarms | 209 |
| 9.1 | Overview | 209 |
| 9.2 | Recognizing Pending Alarms | 211 |
| 9.3 | Displaying alarms | 212 |
| 9.4 | Display infotexts for an alarm | 214 |
| 9.5 | Acknowledge alarm | 215 |
| 9.6 | Edit alarm | 216 |

| | | |
|-----------|--|------------|
| 10 | Operating recipes | 217 |
| 10.1 | Overview | 217 |
| 10.2 | Structure of a recipe | 218 |
| 10.3 | Recipes in the project | 220 |
| 10.4 | Displaying a recipe | 222 |
| 10.5 | Recipe values in the HMI device and the PLC | 225 |
| 10.6 | Operating the recipe view | 226 |
| 10.6.1 | Overview | 226 |
| 10.6.2 | Creating a recipe data record | 227 |
| 10.6.3 | Editing a recipe data record | 229 |
| 10.6.4 | Deleting a recipe data record | 230 |
| 10.6.5 | Synchronizing tags | 231 |
| 10.6.6 | Reading a recipe data record from the PLC | 232 |
| 10.6.7 | Transferring a recipe data record to the PLC | 234 |
| 10.7 | Operating the simple recipe view | 235 |
| 10.7.1 | Overview | 235 |
| 10.7.2 | Creating a recipe data record | 237 |
| 10.7.3 | Editing a recipe data record | 238 |
| 10.7.4 | Deleting a recipe data record | 239 |
| 10.7.5 | Reading a recipe data record from the PLC | 240 |
| 10.7.6 | Transferring a recipe data record to the PLC | 241 |
| 10.8 | Exporting a recipe data record | 242 |
| 10.9 | Importing a recipe data record | 243 |
| 10.10 | Examples | 244 |
| 10.10.1 | Entering a recipe data record | 244 |
| 10.10.2 | Manual production sequence | 245 |
| 11 | Maintenance and care | 247 |
| 11.1 | Maintenance and care | 247 |
| 11.2 | Clean screen on MP 277 Touch | 248 |
| 11.3 | Spare Parts and Repairs | 248 |
| 12 | Technical specifications | 249 |
| 12.1 | Dimension drawings | 249 |
| 12.1.1 | Dimension drawings of the MP 277 8" Touch | 249 |
| 12.1.2 | Dimension drawings of the MP 277 8" Key | 251 |
| 12.1.3 | Dimension Drawings of the MP 277 10" Touch | 252 |
| 12.1.4 | Dimension drawings of the MP 277 10" Key | 254 |
| 12.2 | Specifications | 255 |
| 12.2.1 | Specifications of the MP 277 Touch | 255 |
| 12.2.2 | Specifications of the MP 277 Key | 256 |
| 12.3 | Bit assignment of the direct keys | 258 |
| 12.4 | Description of the ports | 260 |
| 12.4.1 | Power supply | 260 |
| 12.4.2 | X10/IF 1B (RS 422/RS 485) | 260 |
| 12.4.3 | X20, X21 (USB) | 261 |
| 12.4.4 | X1 (Ethernet/LAN) | 261 |

| | | |
|----------|---------------------------|------------|
| A | Appendix..... | 263 |
| | A.1 ESD guideline | 263 |
| | A.2 System alarms | 265 |
| B | Abbreviations..... | 289 |
| | Glossary | 291 |
| | Index..... | 297 |

Overview

1.1 Product overview

Possible applications of the MP 277

The Multi Panel MP 277 units are an extension of the 270 series.

The HMI devices are based on the innovative standard operating system, Microsoft Windows CE 5.0. The Multi Panel MP 277 units belong to the "Multifunctional Platform" product category. The HMI devices offer enhanced communication options to the office world. The Pocket Internet Explorer is already installed on the HMI devices.

The MP 277 offers a variety of application uses, high performance and a favorable cost/performance ratio.

The devices are equipped with:

- PROFIBUS port
- Ethernet port for connection to PROFINET
- 2 USB ports
- TFT screen with up to 64k color

Thanks to the wide range of devices, you get to use the device that is suited to you.

In addition to the classic HMI application WinCC flexible, the HMI devices also support additional applications, for example:

- Sm@rtService
- Sm@rtAccess
- OPC server

1.2 Design of the HMI Device MP 277 8" Touch

Front view and side view

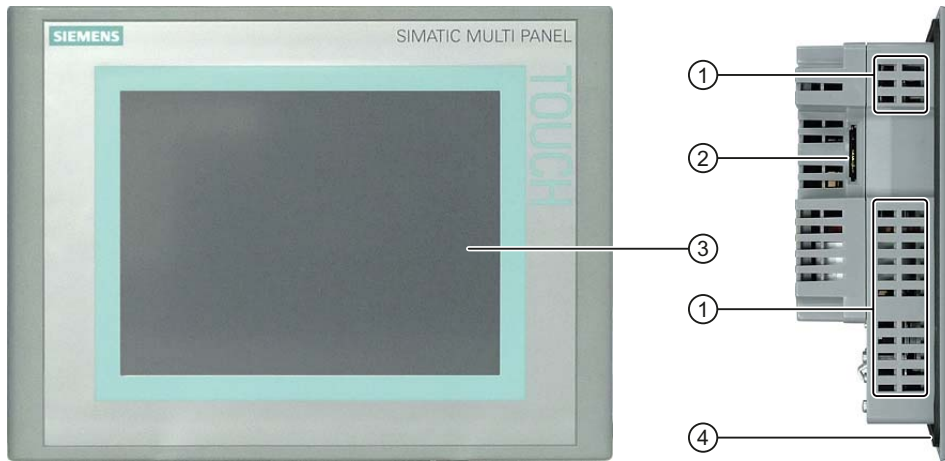

- ① Oblong holes for mounting clamps
- ② Slot for a memory card
- ③ Display / touch screen
- ④ Mounting seal

Bottom view



- ① Oblong holes for mounting clamps
- ② Interfaces

Rear view



- ① Rating plate
- ② Slot for a memory card
- ③ DIP switch
- ④ Interface name
- ⑤ Fixing elements for strain relief

1.3 Design of the HMI Device MP 277 8" Key

Front view and side view

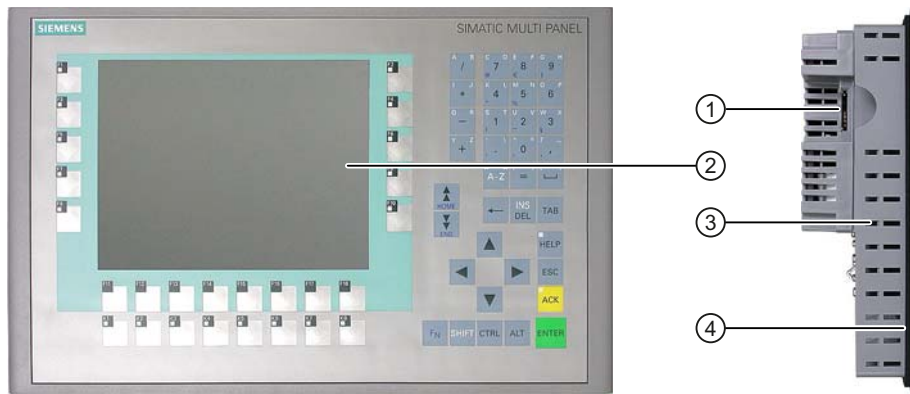

- ① Slot for a memory card
- ② Display
- ③ Oblong holes for mounting clamps
- ④ Mounting seal

Bottom view



- ① Oblong holes for a mounting clamp
- ② Interfaces

Rear view



- ① Rating plate
- ② Slot for a memory card
- ③ DIP switch
- ④ Interface name
- ⑤ Fixing elements for strain relief

1.4 Design of the HMI Device MP 277 10" Touch

Front view and side view

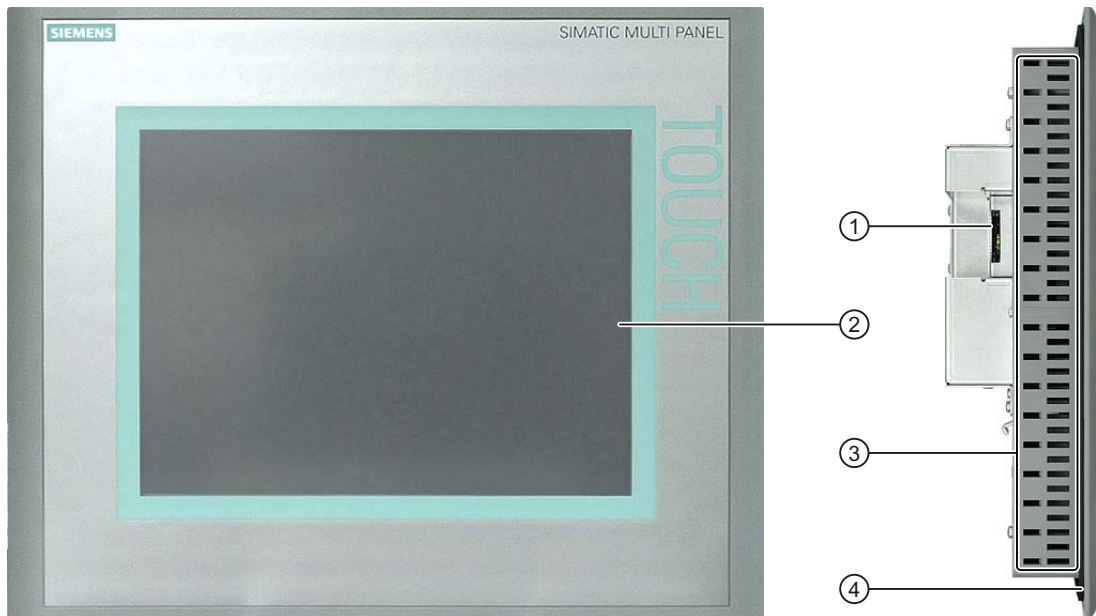

- ① Slot for a memory card
- ② Display / touch screen
- ③ Oblong holes for mounting clamps
- ④ Mounting seal

Bottom view

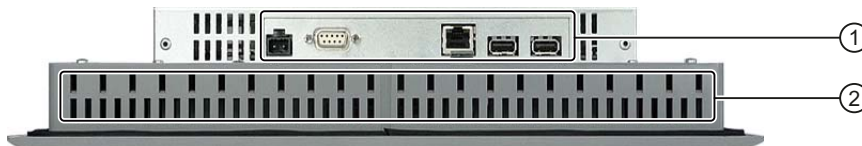

- ① Interfaces
- ② Oblong holes for mounting clamps

Rear view



- ① Rating plate
- ② Slot for a memory card
- ③ DIP switch
- ④ Interface name
- ⑤ Fixing elements for strain relief

1.5 Design of the HMI Device MP 277 10" Key

Front view and side view



- ① Slot for a memory card
- ② Display
- ③ Oblong holes for a mounting clamp
- ④ Mounting seal

Bottom view

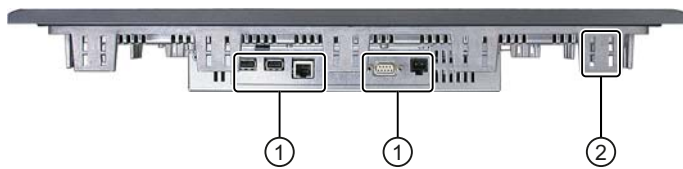

- ① Interfaces
- ② Oblong holes for a mounting clamp

Rear view

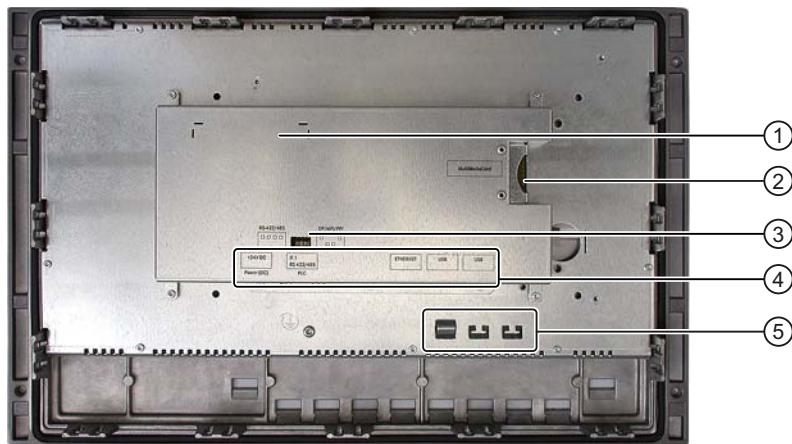

- ① Rating plate
- ② Slot for a memory card
- ③ DIP switch
- ④ Interface name
- ⑤ Fixing elements for strain relief

1.6 Accessory kit

The accessory kit contains the following:

- Mains terminal for the power supply
- Mounting clamps for mounting the HMI device

Additional documents may be enclosed with the accessory kit.

Mounting clamps

Spring clamps or metal mounting clamps are provided for mounting. The mounting clamps hook into oblong holes on the HMI device. The main dimensions of the HMI device are not exceeded by this.

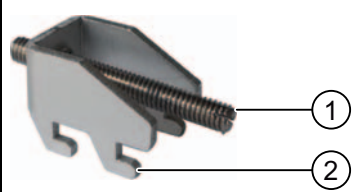
| Spring clamp | Metal mounting clamp |
|--|---|
|  <p>① Slot ② Hook</p> |  <p>① Threaded pin ② Hook</p> |

A product information with notes on mounting of the HMI device with mounting clamps is supplied with the HMI device.

The product information is available in the Internet at the following links:

- Product Information "Metal mounting clamp":
["http://support.automation.siemens.com/WW/view/en/34915725"](http://support.automation.siemens.com/WW/view/en/34915725)
- Product Information "Spring clamp":
["http://support.automation.siemens.com/WW/view/en/34916893"](http://support.automation.siemens.com/WW/view/en/34916893)

1.7 Accessories

Accessories are not included in the product package of the HMI device, but can be ordered in the Internet at "<http://mall.automation.siemens.com>".

Converter RS 422-RS 232

The converter is required for the connection of controllers of other manufacturers. Connect the RS 422 to RS 232 converter to the RS 422 / RS 485 interface. The converter converts the input signals to RS-232 signals.

Order number: 6AV6 671-8XE00-0AX0

PC/PPI cable

You need the cable to update the operating system with reset to factory settings. You can also use the cable for data transfer. Connect the PC/PPI cable to the RS 422/RS 485 port. The cable converts the input signals to RS-232 signals.

Order number: 6ES7 901-3CB30-0XA0

Note

Set a lower bit rate if the connection is lost during the operating system update. If you use a high bit rate, you need to use PC/PPI cable version 3 or higher. The version code is printed on the cable ("E stand 3," for example, corresponds to version 3).

90° elbow adapter

If space is limited, you can use an elbow adapter at the RS 422/RS 485 interface.

Order number: 6AV6 671-8XD00-0AX0

Protective foil

The protective foil prevents the touch screen from being scratched.

Protective foil is available under the following order numbers:

| Protective foil HMI device | Order number |
|----------------------------|--------------------|
| MP 277 8" Touch | 6AV6671-3CC00-0AX0 |
| MP 277 10" Touch | 6AV6671-3DC00-0AX0 |

Clamping frame

IP65 degree of protection or enclosure type 4X/type 12 can be achieved with a clamping frame even with little material thickness at the mounting cut-out. For additional information, see Section Preparing for Mounting (Page 42).

Clamping frames are available with the following order numbers:

| Clamping frame for HMI device | Order number |
|-------------------------------|--------------------|
| MP 277 8" Touch | 6AV6671-3CS00-0AX0 |
| MP 277 8" Key | 6AV6671-3CS01-0AX0 |
| MP 277 10" Touch | 6AV6671-8XS00-0AX0 |

Memory card

Only use SD memory cards, CF memory cards or MultiMediaCards tested and approved by Siemens AG.

Service pack

Content of the service package for all HMI devices:

- Mounting seals
- Mounting clamps
- Power supply terminal, 2-pin

Order number: 6AV6671-3XA01-0AX1

1.8 The HMI device in the operating process

The HMI device is part of the operating process. The following two phases are key to the way the HMI device is integrated in the operating process:

- Project design
- Process management

Project design

Visualization of the operating process is known as project design. Project design comprises:

- writing project data
- saving project data
- testing project data
- simulating project data

Project design is undertaken independently of the HMI device and results in a project. Once this has been generated, the project can be transferred to the HMI device to control the operating process.

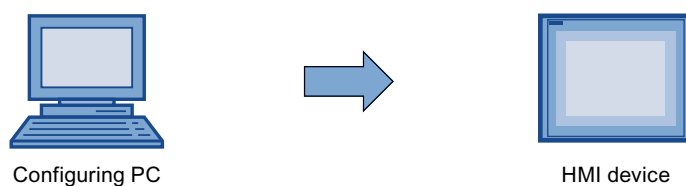

Process management

Process management is marked by two-way communication between HMI device and controller. This lays the foundations for operator control and monitoring.

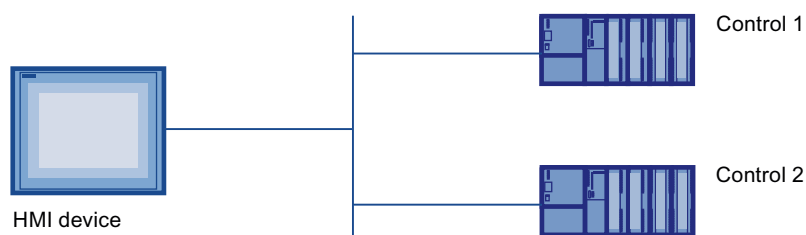

The operator can intervene in the operating process on the HMI device for control purposes. The controller in turn supplies the results of the operating process which are displayed on the HMI device.

1.9 Functional Scope with WinCC flexible

The following tables show the objects that can be integrated in a project for an MP 277.

Messages

| Object | Specification | MP 277 |
|-------------------------|--|--------------------------------------|
| Messages | Number of discrete alarms | 4 000 |
| | Number of analog alarms | 200 |
| | Length of the alarm text | 80 characters |
| | Number of tags in an alarm | Max. 8 |
| | Display | Alarm line, Alarm window, Alarm view |
| | Acknowledge error alarm individually | Yes |
| | Acknowledge multiple error alarms simultaneously (group acknowledgement) | 16 alarm groups |
| | Edit alarm | Yes |
| | Alarm indicator | Yes |
| ALARM_S | Display S7 alarms | Yes |
| Alarm buffer, retentive | Alarm buffer capacity | 512 alarms |
| | Simultaneously queued alarm events | Max. 250 |
| | View alarm | Yes |
| | Delete alarm buffer | Yes |
| | Print alarm by line | Yes |

Tags, values and lists

| Object | Specification | MP 277 |
|------------------|---------------|-------------------|
| Tags | Number | 2 048 |
| Limit monitoring | Input/output | Yes |
| Linear scaling | Input/output | Yes |
| Text lists | Number | 500 ¹⁾ |
| Graphics lists | Number | 400 ¹⁾ |

¹⁾ The maximum total of text and graphics lists is 500.

Screens

| Object | Specification | MP 277 |
|---------|--|--------|
| Screens | Number | 500 |
| | Fields per screen | 200 |
| | Tags per screen | 200 |
| | Complex objects per screen (for example, bars) | 10 |
| | Template | Yes |

Recipes

| Object | Specification | MP 277 |
|---------|-------------------------|--|
| Recipes | Number | 300 |
| | Data records per recipe | 500 |
| | Entries per recipe | 1 000 |
| | Recipe memory | 64 KB |
| | Storage location | <ul style="list-style-type: none"> • Memory card ¹⁾ • USB memory stick ¹⁾ • Network drive |

- ¹⁾ The number of recipe data records might be restricted by the capacity of the storage medium.

Logs

Note

The HMI devices are suitable for the logging of relatively small volumes of data.

Manage the data in several adjacent archives in a segmented circular log. The use of a large circular log has a negative effect on performance.

| Object | Specification | MP 277 |
|--------|--|--|
| Logs | Number of logs | 20 |
| | Number of partial logs in a segmented circular log | 400 |
| | Entries per log | 10 000 |
| | Filing format | <ul style="list-style-type: none"> • CSV with ANSI character set |
| | Storage location | <ul style="list-style-type: none"> • Memory card ¹⁾ • USB memory stick ¹⁾ • Network drive |

- ¹⁾ The number of entries in the log may be restricted by the capacity of the storage medium.

Safety

| Object | Specification | MP 277 |
|--------|--------------------------|--------|
| Safety | Number of user groups | 50 |
| | Number of users | 50 |
| | Number of authorizations | 32 |

Info texts

| Object | Specification | MP 277 |
|------------|---|----------------------------|
| Info texts | Length (no. of characters) | 320 (depending on font) |
| | For alarms | Yes |
| | For screens | Yes |
| | For screen objects (for example, for I/O field, switch, button, invisible button) | Yes |

Additional functions

| Object | Specification | MP 277 |
|--------------------|--|--------|
| Screen settings | Calibrating the touch screen ¹⁾ | Yes |
| | Brightness setting | Yes |
| Language switching | Number of languages | 16 |
| VBScript | User-specific extension of the functionality | Yes |
| | Number of scripts | 50 |
| Graphic objects | Vector and pixel graphics | Yes |
| Trends | Number | 300 |
| Scheduler | Number of tasks | 48 |
| Text objects | Number | 10 000 |
| Direct keys | PROFIBUS DP direct keys | Yes |
| | PROFINET IO direct keys | Yes |

¹⁾ Only MP 277 Touch

1.10 Software options

The following software options are available for the MP 277:

- Sm@rtService

The Sm@rtService option enables you to access a remote HMI device from the HMI device or PC via Ethernet.

- Sm@rtAccess

The Sm@rtAccess option enables you to set up communication between different HMI systems.

- /Audit

The /Audit option extends the HMI device to include functions for recording operations in an audit trail and electronic signature.

- OPC server (OPC XML)

The OPC-Server option enables you to create communications to OPC-capable applications from an HMI device or PC via Ethernet.

1.11 Communications

Number of connections

| Connection | MP 277 |
|--|--------|
| Number using a bus connection | 6 |
| Number of connections based on "SIMATIC HMI HTTP Protocol" | 8 |

Note

In the following cases, you may not enable PROFINET IO in the Control Panel of the HMI device:

- Use of PLCs from other manufacturers
- Use of SIMATIC 500/505 via NITP

PLCs

The following table shows the PLCs which can be used with the HMI devices and the protocols or profiles which can be used.

| PLC | Protocol | MP 277 |
|--|--|--------|
| SIMATIC S7 | <ul style="list-style-type: none"> • PPI • MPI ¹⁾ • PROFIBUS DP • TCP/IP (Ethernet) | Yes |
| SIMATIC S5 | <ul style="list-style-type: none"> • PROFIBUS DP | Yes |
| SIMATIC 500/505 | <ul style="list-style-type: none"> • NITP • PROFIBUS DP | Yes |
| SIMATIC HMI HTTP Protocol | <ul style="list-style-type: none"> • HTTP/HTTPS (Ethernet) | Yes |
| Allen-Bradley | PLC series SLC500, SLC501, SLC502, SLC503, SLC504, SLC505, MicroLogix and PLC5/11, PLC5/20, PLC5/30, PLC5/40, PLC5/60, PLC5/80 <ul style="list-style-type: none"> • DF1 ^{2) 5)} • DH+ via KF2 module ³⁾ • DH485 via KF3 module ⁴⁾ • DH485 ⁴⁾ | Yes |
| GE Fanuc Automation | PLC series 90-30, 90-70, VersaMax Micro <ul style="list-style-type: none"> • SNP | Yes |
| LG Industrial Systems (Lucky Goldstar) / IMO | PLC series GLOFA GM (GM4, GM6 and GM7) / Series G4, G6 and G7 <ul style="list-style-type: none"> • Dedicated communication | Yes |
| Mitsubishi Electric | PLC series MELSEC FX and MELSEC FX0 <ul style="list-style-type: none"> • FX | Yes |

| PLC | Protocol | MP 277 |
|-----------------------------------|--|--------|
| Mitsubishi Electric | PLC series MELSEC FX0, FX1n, FX2n, AnA, AnN, AnS, AnU, QnA and QnAS <ul style="list-style-type: none"> • Protocol 4 | Yes |
| OMRON | PLC series SYSMAC C, SYSMAC CV, SYSMAC CS1, SYSMAC alpha and CP <ul style="list-style-type: none"> • Hostlink/Multilink (SYSMAC Way) | Yes |
| Modicon (Schneider Automation) | PLC series Modicon 984, TSX Quantum and TSX Compact <ul style="list-style-type: none"> • Modbus RTU ⁵⁾ PLC series Quantum, Momentum, Premium and Micro PLC series Compact and 984 via Ethernet bridge <ul style="list-style-type: none"> • Modbus TCP/IP (Ethernet) | Yes |

- 1) Not possible when connected to S7-212.
- 2) Applies to controllers SLC503, SLC504, SLC505, PLC5, MicroLogix
- 3) Applies to controllers SLC504, PLC5 over DF1
- 4) Applies to controllers SLC500 to SLC 505 and MicroLogix
- 5) Only with converter RS 422-RS 232 6AV6 671-8XE00-0AX0 (option)

Safety instructions and approvals

2.1 Safety Instructions

Working on the control cabinet

| |
|--|
|  WARNING |
| <p>Open equipment</p> <p>The HMI device is open equipment. This means that the HMI device may only be mounted in housings or cabinets, whereby the device can be operated from the front panel.</p> <p>The cubicle or cabinet in which the HMI device is installed may only be accessed with a key or tool and only by trained, authorized personnel.</p> <p>Dangerous voltage</p> <p>Opening the cabinet will expose high voltage parts. Contact with these parts could be fatal.</p> <p>Disconnect the cabinet from the mains before opening it.</p> |

Potentially explosive atmospheres

When operating the HMI device in hazardous areas the following warning applies.

| |
|---|
|  WARNING |
| <p>Explosion Hazard</p> <p>Do not disconnect while circuit is live unless area is known to be non-hazardous.</p> <p>Substitution of components may impair suitability for Class I, Division 2 or Zone 2.</p> |

High frequency radiation

| |
|---|
| NOTICE |
| <p>Unintentional operating situations</p> <p>High frequency radiation, for example, from cellular phones, can trigger unwanted operating states.</p> |

Installation as intended

| |
|---|
|  WARNING |
| Installation only in machinery that conforms to the machinery directive |
| Commissioning the HMI device is prohibited until it has been absolutely ensured that the machine in which the HMI device is to be installed complies with Directive 98/37/EC or Directive 2006/42/EC as of December 29, 2009. |

2.2 Standards, certificates and approvals

Approvals

| |
|--|
|  CAUTION |
| The following overview shows possible approvals. |
| The HMI device itself is certified as shown on the label on its rear panel. |

CE approval



The automation system meets the general and safety-related requirements of the following EC directives and conforms to the harmonized European standards (EN) for programmable logic controllers published in the official gazettes of the European Union:

- 2004/108/EC "Electromagnetic Compatibility" (EMC Directive)
- 2006/95/EC "Electrical equipment for use within specific voltage limits" (Low-Voltage Directive)

EC Declaration of Conformity

The EC Declarations of Conformity are available to the relevant authorities at the following address:

Siemens AG
Industry Sector
I IA AS R&D DH A
P.O. Box 1963
92209 Amberg
Germany

UL approval



Underwriters Laboratories Inc., conforming to

- UL 508 (Industrial Control Equipment)
- CSA C22.2 No. 142 (Process Control Equipment)

or

Underwriters Laboratories Inc., conforming to

- UL 508 (Industrial Control Equipment)
- CSA C22.2 No. 142 (Process Control Equipment)
- UL 1604 (Hazardous Location)
- CSA-213 (Hazardous Location)

Approved for use in

- Class I, Division 2, Group A, B, C, D or
- Class I, Zone 2, Group IIC or
- non-hazardous locations



FM approval



Factory Mutual Research (FM) conforming to

- Approval Standard Class Number 3611, 3600, 3810

Approved for use in

- Class I, Division 2, Group A, B, C, D T4
- Class I, Zone 2, Group IIC T4

Marking for Australia



The HMI device fulfills the requirements of standard AS/NZS 2064 (Class A).

IEC 61131

The HMI device satisfies the requirements and criteria conforming to IEC 61131-2, Programmable Logic Controllers, Part 2: Operating resource requirements and tests.

2.3 Notes about usage

Industrial applications

The HMI device is designed for industrial applications. It conforms to the following standards:

- Requirements for emissions EN 61000-6-4: 2007
- Requirements for interference immunity EN 61000-6-2: 2005

Use in residential areas

Note

The HMI device is not intended for use in residential areas. Operation of an HMI device in residential areas can have a negative influence on radio/TV reception.

If the HMI device is used in a residential area, you must take measures to achieve Limit Class B conforming to EN 55011 for RF interference.

Suitable measures for achieving the degree of noise suppression for Limit Class B include, for example:

- Installation of the HMI device in grounded control cabinets
- Use of filters in electrical supply lines

Individual acceptance is required.

2.4 Electromagnetic compatibility

Introduction

The HMI device fulfills, among other things, the requirements of the EMC law pertaining to the domestic European market.

EMC-compatible installation of the HMI device

The EMC-compliant installation of the HMI device and the application of interference-proof cable is the basis for interference-free operation. The "Directives for interference-free installation of PLCs" and the "PROFIBUS Networks" manual also apply for the installation of the HMI device.

Pulse-shaped disturbance

The following table shows the electromagnetic compatibility of modules with regard to pulse-shaped interference. The precondition for electromagnetic compatibility is that the HMI device meets the specifications and guidelines for electrical installation.

| Pulse-shaped disturbance | Tested with | Degree of severity |
|---|--|--------------------|
| Electrostatic discharge in accordance with IEC 61000-4-2 | Air discharge: 8 kV Contact discharge: 6 kV | 3 |
| Burst pulses (high-speed transient interference) in accordance with IEC 61000-4-4 | 2 kV power supply cable 2 kV signal cable, > 30 m 1 kV signal cable, < 30 m | 3 |
| High-power surge pulses in accordance with IEC 61000-4-5, external protective circuit required (refer to the manual Automation System S7-300, Installation, "Lightning and overvoltage protection" section) | | |
| Asymmetrical coupling | 2 kV power cable DC voltage with protective elements 2 kV signal/data cable, > 30 m, with protective elements as required | 3 |
| Symmetrical coupling | 1 kV power cable DC voltage with protective elements 1 kV signal cable, > 30 m, with protective elements as required | 3 |

Sinusoidal interference

The following table shows the EMC behavior of the modules with respect to sinusoidal interference. This requires the HMI device to meet the specifications and directives for electrical installation.

| Sinusoidal interference | Test values | Degree of severity |
|---|--|--------------------|
| HF radiation (in electromagnetic fields) in accordance with IEC 61000-4-3 | <ul style="list-style-type: none"> 80% amplitude modulation at 1 kHz with 10 V/m in the range of 80 MHz to 1 GHz with 3 V/m in the range 1.4 GHz to 2 GHz with 1 V/m the range 2 GHz to 2.7 GHz 10 V/m with 50% pulse modulation at 900 MHz 10 V/m with 50% pulse modulation at 1.89 GHz | 3 |
| RF interference current on cables and cable shielding conforming to IEC 61000-4-6 | Test voltage 10 V, with 80% amplitude modulation of 1 kHz in the 9 MHz to 80 MHz range | 3 |

Emission of radio interference

The following table shows the unwanted emissions from electromagnetic fields in accordance with EN 55011, Limit Value Class A, Group 1, measured at a distance of 10 m.

| | |
|----------------------|---------------------------|
| From 30 to 230 MHz | < 40 dB (µV/m) quasi-peak |
| From 230 to 1000 MHz | < 47 dB (µV/m) quasi-peak |

Additional measures

If you want to connect an HMI device to the public power supply system, you must ensure Limit Value Class B in accordance with EN 55022.

2.5 Transport and storage conditions

Mechanical and climatic conditions for transportation and storage

This HMI device meets the requirements for IEC 61131-2 relating to transportation and storage conditions. The following specifications apply to the transportation and storage of an HMI device in its original packaging.

The climatic conditions conform to the following standards:

- IEC 60721-3-3, Class 3K7 for storage
- IEC 60721-3-2, Class 2K4 for transport

The mechanical conditions correspond to IEC 60721-3-2, Class 2M2.

| Type of condition | Permitted range |
|---|--|
| Drop test (in transport package) | ≤ 1 m |
| Temperature | From -20 to +60° C |
| Atmospheric pressure | From 1 140 hPa to 660 hPa, corresponds to an elevation of -1 000 to 3 500 m |
| Relative humidity | From 10 to 90%, without condensation |
| Sinusoidal vibration in accordance with IEC 60068-2-6 | 5 to 9 Hz: 3.5 mm 9 Hz to 500 Hz: 9.8 m/s ² |
| Shock in accordance with IEC 60068-2-29 | 250 m/s ² , 6 ms, 1 000 shocks |

| NOTICE |
|--|
| <p>Avoid condensation</p> <p>If the HMI device is subjected to low temperatures or extreme fluctuations in temperature during transportation, moisture could occur on or inside the HMI device. Condensation can occur. This can cause malfunctions.</p> <p>The HMI device must have acquired room temperature before it is put into operation. Do not expose the HMI device to direct radiation from a heater in order to warm it up. If there is condensation, wait approximately 4 hours until the HMI device has dried completely before switching it on.</p> |

Proper transport and storage, installation and assembly as well as careful operation and maintenance are required to ensure trouble-free and safe operation of the HMI device.

The warranty for the HMI device will be deemed void if these stipulations are not heeded.

Planning application

3.1 Notes about usage

Mechanical and climatic conditions of use

The HMI device is designed for use in a location protected from the effects of the weather. The conditions of use meet the requirements for DIN IEC 60721-3-3:

- Class 3M3 (mechanical requirements)
- Class 3K3 (climatic requirements)

Use with additional measures

The HMI device should not be used at the following locations unless additional measures are taken:

- In locations with a high degree of ionizing radiation
- In locations with severe operating conditions, for example, due to:
 - Corrosive vapors, gases, oils or chemicals
 - Electrical or magnetic fields of high intensity
- In plants that require special monitoring, for example:
 - Elevators
 - Systems in especially hazardous rooms

Mechanical environmental conditions

The mechanical environmental conditions for the HMI device are specified in the following table in terms of sinusoidal vibration.

| Frequency range | Constant | Occasional |
|--------------------|-----------------------------|---------------------------|
| 10 Hz ≤ f ≤ 58 Hz | Amplitude 0.0375 mm | Amplitude 0.075 mm |
| 58 Hz ≤ f ≤ 150 Hz | Constant acceleration 0.5 g | Constant acceleration 1 g |

Reducing vibrations

If the HMI device is subjected to greater shocks or vibrations, you must take appropriate measures to reduce acceleration or amplitudes.

We recommend mounting the HMI device on damping materials (on rubber-metal vibration dampers, for example).

Testing mechanical environmental conditions

The following table provides information on the type and scope of tests for mechanical environmental conditions.

| Test for | Test standard | Comments |
|------------|--|--|
| Vibrations | Vibration test in accordance with IEC 60068, part 2-6 (sinusoidal) | Type of vibration: Transitional rate of the frequency: 1 octave/minute. 10 Hz ≤ f ≤ 58 Hz, constant amplitude of 0.075 mm 58 Hz ≤ f ≤ 150 Hz, constant acceleration 1 g Vibration duration: 10 frequency cycles per axis at each of the three associated vertical axes |
| Shock | Shock test in accordance with IEC 60068, Part 2 -29 | Type of shock: Half-sine Shock intensity: Peak value 15 g, duration 11 ms Direction of impact: 3 shocks in ± direction at each one of the three associated vertical axes |

Climatic environmental conditions

The following table shows the climatic conditions for operation of the HMI device.

| Environmental conditions | Permitted range | Comments |
|---|---|---|
| Temperature <ul style="list-style-type: none"> • Vertical mounting • Mounting at an angle | From 0 to 50° C From 0 to 40° C | See the "Mounting positions and type of fixation" section |
| Relative humidity | 10 to 90%, without condensation | |
| Atmospheric pressure | 1 140 to 795 hPa | Corresponds to an elevation of -1 000 to 2 000 m |
| Pollutant concentration | SO ₂ : < 0,5 ppm; Relative humidity < 60%, no condensation | Test: 10 cm ³ /m ³ ; 10 days |
| | H ₂ S: < 0.1 ppm; Relative humidity < 60%, no condensation | Test: 1 cm ³ /m ³ ; 10 days |

3.2 Mounting positions

Mounting position

The HMI device is suitable for installation in:

- Mounting cabinets
- Control cabinets
- Switchboards
- Consoles

In the following, all of these mounting options are referred to by the general term "cabinet".

The HMI device is self-ventilated and approved for vertical and inclined mounting in stationary cabinets.

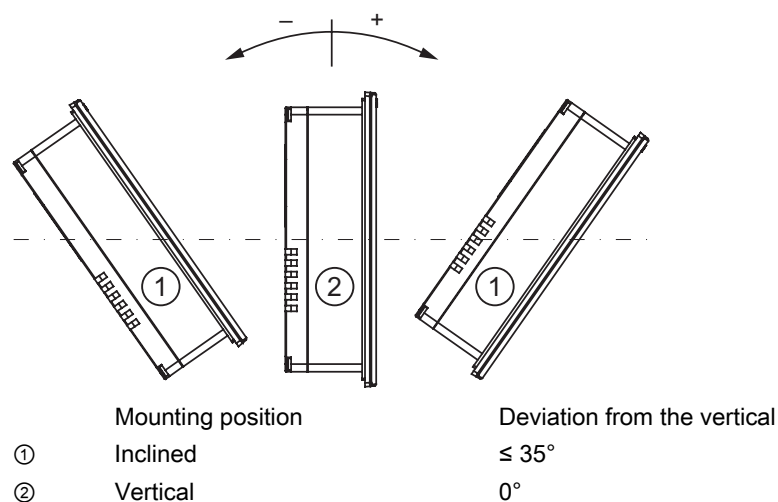

CAUTION

Damage due to overheating

Convection through the HMI device is reduced with installation at an angle. This fact also reduces the maximum permitted operating temperature for operation. With sufficient forced ventilation, you can operate the HMI device at an inclined mounting position up to the permitted ambient temperature for vertical installation. Otherwise the HMI device may be damaged and the approvals and warranty may become obsolete.

3.3 Preparing for Mounting

Select the mounting location of the HMI device

Points to observe when selecting the mounting location:

- Position the HMI device so that it is not subjected to direct sunlight.
- Position the HMI device such that it is ergonomically accessible for the user. Choose a suitable mounting height.
- Ensure that the air vents of the HMI device are not covered as a result of the mounting.
- Observe the permissible mounting positions for the HMI device.

| |
|---|
| NOTICE |
| Stability of the mounting cut-out |
| The material in the area of the mounting cut-out must provide sufficient strength to guarantee enduring and safe mounting of the HMI device. |
| The force of the clamps or operation of the device may not lead to deformation of the material in order to achieve the degrees of protection described below. |
| The material thickness at the mounting cut-out must be at least 1.0 mm. |

Degrees of protection

The protection ratings are only ensured if the mounting cutout conforms to the following:

- Permitted deviation from plane at the mounting cutout: $\leq 0,5$ mm
This condition must be fulfilled for the mounted HMI device.
- Permissible surface roughness in the area of the seal: ≤ 120 μm (R_z 120)
- With IP65 degree of protection or for enclosure type 4X/type 12 (indoor use only), the material thickness at the mounting cut-out can be a maximum of 6 mm.

Spring clamps or metal mounting clamps, each with or without clamping frames, are used depending on the material thickness at the mounting cut-out.

The relationships are shown in the table below:

| Material thickness | Spring clamp | Metal mounting clamp | Clamping frame required |
|--------------------|--------------|----------------------|-------------------------|
| 1,0 mm to 1,5 mm | x | x | Yes |
| 1,5 to 2 mm | x | - | No |
| | - | x | Yes |
| 2 to 4 mm | x | - | No |
| 4 to 6 mm | - | x | No |

The clamping frame is available as an accessory, see section Accessories (Page 23).

Dimensions of the mounting cut-out

The following table shows the dimensions of the required mounting cut-out:

| Mounting cut-out | MP 277 8" Touch | MP 277 8" Key | MP 277 10" Touch | MP 277 10" Key |
|------------------|----------------------|----------------------|----------------------|----------------------|
| Width | 226 ⁺¹ mm | 338 ⁺¹ mm | 310 ⁺¹ mm | 434 ⁺¹ mm |
| Height | 166 ⁺¹ mm | 206 ⁺¹ mm | 248 ⁺¹ mm | 291 ⁺¹ mm |
| Depth | 61 mm | 61 mm | 61 mm | 60 mm |

Mounting compatibility

The mounting cut-outs of the Multi Panels are compatible with the mounting cut-outs of the following SIMATIC HMI devices:

| Multi Panel mounting cut-out | Compatible to the mounting cut-outs of the HMI device | |
|------------------------------|---|--|
| MP 277 10" Touch | Thin Client 10" Touch KTP1000 Basic TP 270 10" | MP 270B 10" Touch MP 277 INOX 10" Touch MP 377 12" Touch |
| MP 277 10" Key | MP 270B 10" Key | OP 270 10" |

Maintaining clearances

The HMI device must be installed with the following clearances:

- Always allow 50 mm above and below the mounting cutout respectively for ventilation
- Right and left of the mounting cut-out respectively for attaching the mounting clamps:
 - When using a clamping frame: 25 mm each
 - Without clamping frame, with spring clamps: 25 mm each
 - Without clamping frame, with metal mounting clamps: 15 mm each
- At least 10 mm behind the rear panel of the HMI device

| |
|---|
| NOTICE |
| Ensure that the maximum ambient temperature is not exceeded when mounting the device in a cabinet and especially in a closed enclosure. |

3.4 Specifications for Insulation Tests, Protection Class and Degree of Protection

Test voltages

Insulation stability is demonstrated in the type test with the following test voltages in accordance with IEC 61131-2:

| Circuits with a nominal voltage of U_n to other circuits or ground | Test voltage |
|--|--------------|
| < 50 V | 500 V DC |

Protection class

Protection Class I in accordance with IEC 60536, i.e. protective conductor connection to profile rail required.

Protection against foreign objects and water

| Degree of protection in accordance with IEC 60529 | Explanation |
|---|---|
| Front | When mounted: <ul style="list-style-type: none"> • IP65 • Enclosure Type 4X/Type 12 (indoor use only) |
| Rear panel | IP20 Touch protection test with standard test probes. There is no protection against ingress by water. |

The degree of protection provided by the front side can only be guaranteed when the mounting seal lies completely against the mounting cut-out.

3.5 Rated voltages

The following table shows the rated voltage and the corresponding tolerance range.

| Nominal voltage | Tolerance range |
|-----------------|---------------------------------|
| +24 VDC | 20.4 V to 28.8 V (-15 %, +20 %) |

Mounting and connecting

4.1 Checking the package contents

Check the package contents for visible signs of transport damage and for completeness.

| |
|--|
| NOTICE |
| Damaged parts A damaged part will cause the HMI device to malfunction. Do not install parts damaged during shipment. In the case of damaged parts, contact your Siemens representative. |

The following is supplied along with the HMI device:

- HMI device
- Accessory kit with mounting clamps and mains terminal

Additional documents may be included in the product package of all HMI devices.

The documentation belongs to the HMI device and is required for subsequent commissioning. Retain all enclosed documentation for the entire service life of the HMI device. You must pass on the enclosed documentation to any subsequent owner or user of the HMI device. Make sure that every supplement to the documentation that you receive is stored together with the operating instructions.

4.2 Mounting the HMI Device

Requirement

All packaging components and protective foils should be removed from the HMI device.

To install the HMI device, you need the mounting clamps from the accessories. The mounting seal must be fitted on the HMI device. If the mounting seal is damaged, order a replacement seal. The mounting seal is part of the associated service pack.

Mounting

| |
|---------------|
| NOTICE |
|---------------|

| |
|---|
| Always mount the HMI device according to the instructions in this manual. |
|---|

Proceed as follows:

1. Check that the mounting seal is fitted on the HMI device.
Do not install the mounting seal turned inside out. This may cause leaks in the mounting cut-out.
2. Insert the HMI device into the mounting cutout from the front.
3. Insert a mounting clamp into a recess on the HMI device.
4. Fasten the mounting clamp as described in the corresponding product information. The product information on metal mounting clamps or spring clamps is available in the Internet at the following link:
 - Product Information "Metal mounting clamp":
["http://support.automation.siemens.com/WW/view/en/34915725"](http://support.automation.siemens.com/WW/view/en/34915725)
 - Product Information "Spring clamp":
["http://support.automation.siemens.com/WW/view/en/34916893"](http://support.automation.siemens.com/WW/view/en/34916893)
5. Repeat steps 3 and 4 for all mounting clamps that are required for the installation of the HMI device.

| |
|---------------|
| NOTICE |
|---------------|

| |
|---|
| Check the fit of the mounting seal on the front. The mounting seal must not protrude from the HMI device. |
|---|

| |
|---------------------------------|
| Otherwise, repeat steps 1 to 5. |
|---------------------------------|

Positions of mounting clamps on the MP 277 8" Touch

You will need 10 mounting clamps in total. The following figure shows the positions of the mounting clamps.

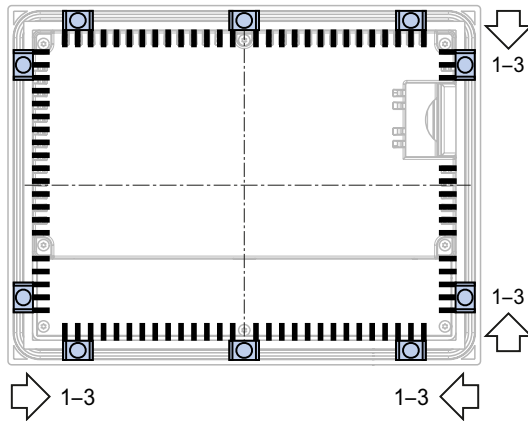

Positions of mounting clamps on the MP 277 10" Touch

You will need 12 mounting clamps in total. The following figure shows the positions of the mounting clamps.

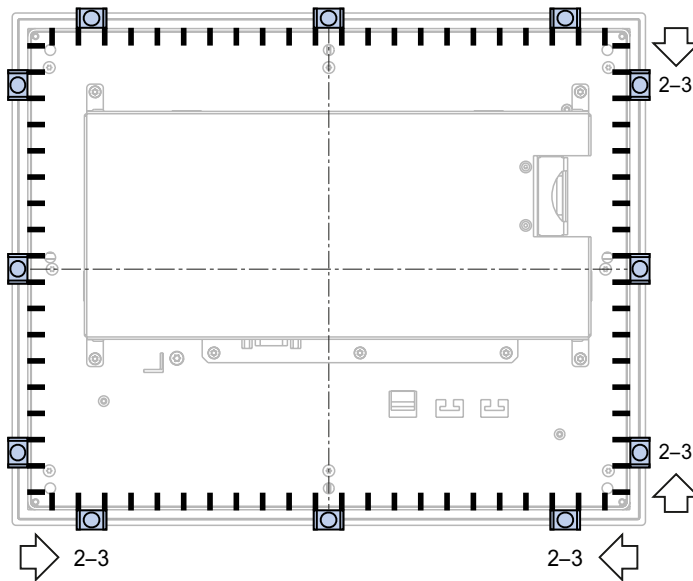

Positions of the mounting clamps on the MP 277 8" Key

You will need 14 mounting clamps in total. The following figure shows the positions of the mounting clamps.

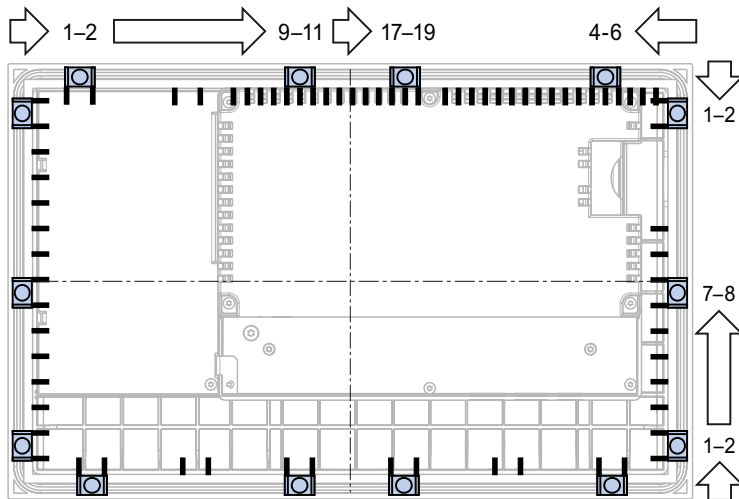

Positions of the mounting clamps on the MP 277 10" Key

You will need 10 mounting clamps in total. The following figure shows the positions of the mounting clamps.

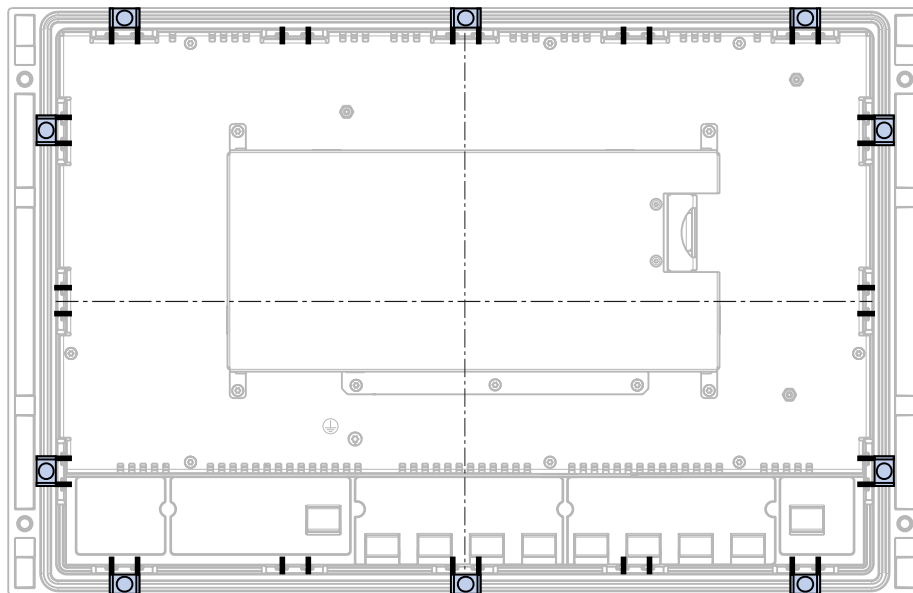

4.3 Connecting the HMI device

4.3.1 Overview

Requirement

- The HMI device must be mounted according to the specifications of these operating instructions.
- Always use shielded standard cables.

Additional information is available in the catalog and online order system at "<http://mall.automation.siemens.com>".

Connection sequence

| |
|---|
| NOTICE |
| Damage to the HMI device If you do not keep to the connection sequence you could damage the HMI device. Ensure you connect the HMI device in the sequence described above. |

1. Equipotential bonding
 2. Power supply
Perform a power-up test to ensure the power supply is connected with the correct polarity.
 3. Controller
 4. Configuration PC as necessary
 5. I/Os as necessary
- Disconnect the HMI device by completing the above steps in reverse order.

Connecting the cables

When connecting the cables, ensure that the contact pins are not bent. Secure the cable connectors by screwing the connector onto the socket.

See also

Safety Instructions (Page 31)

4.3.2 Ports

The following figure shows the interfaces of the MP 277 HMI device.

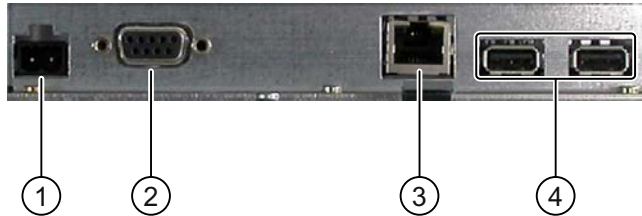

- ① Power supply connector
- ② RS-422/RS-485 interface X10 / IF1b
- ③ Ethernet interface
- ④ USB ports X20 and X21

See also

- Power supply (Page 260)
- X10/IF 1B (RS 422/RS 485) (Page 260)
- X20, X21 (USB) (Page 261)
- X1 (Ethernet/LAN) (Page 261)

4.3.3 Connecting the equipotential bonding circuit

Differences in electrical potential

Differences in potential may occur between spatially separated system parts. Such differences in electrical potential can lead to high equalizing currents over the data cables and therefore to the destruction of their interfaces. Equalizing currents can develop if the cable shielding is terminated at both ends and grounded to different parts of the system.

Differences in potential can develop when a system is connected to different mains.

General requirements of equipotential bonding

Differences in electrical potential must be reduced using equipotential bonding to ensure trouble-free operation of the relevant components of the electronic system. The following must therefore be observed when installing the equipotential bonding circuit:

- The effectiveness of equipotential bonding increases as the impedance of the equipotential bonding conductor decreases or as its cross-section increases.
- If two plant parts are interconnected by means of shielded data cables and their shielding is bonded at both ends to the grounding/protective conductor, the impedance of the additionally installed equipotential bonding cable must not exceed 10% of the shielding impedance.
- The cross-section of a selected equipotential bonding conductor must be capable of handling the maximum equalizing current. Experience has shown that equipotential bonding conductors with a minimum cross-section of 16 mm² should be fitted between the control cabinets or the ground point of the supporting arm or the stand for PRO HMI devices.
- Use equipotential bonding conductors made of copper or galvanized steel. Establish a large surface contact between the equipotential bonding conductors and the grounding/protective conductor and protect them from corrosion.
- Use a suitable cable clip to clamp the shield of the data cable flush to the equipotential bonding rail. Keep the length of cable between the HMI device and the equipotential bonding rail as short as possible.
- Route the equipotential bonding conductor and data cables in parallel and with minimum clearance between them.

Configuration graphic

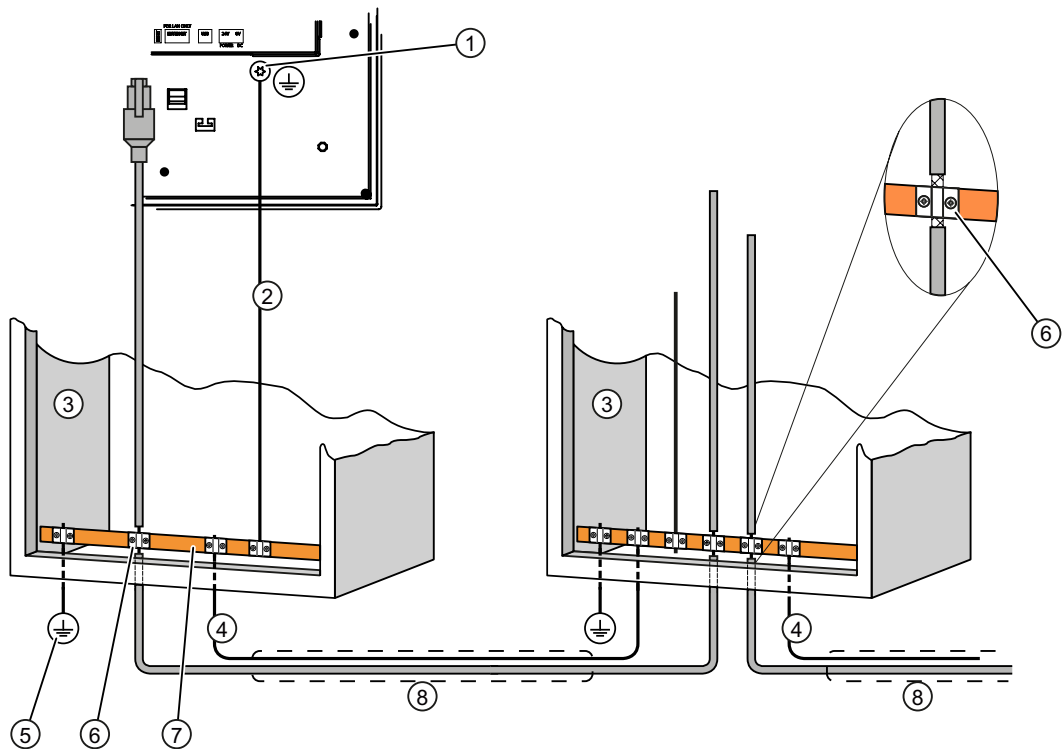

- ① Chassis terminal on the HMI device, example
- ② Equipotential bonding conductor cross-section: 4 mm²
- ③ Control cabinet
- ④ Equipotential bonding conductor cross-section: min. 16 mm²
- ⑤ Ground connection
- ⑥ Cable clip
- ⑦ Equipotential bonding rail
- ⑧ Parallel routing of the equipotential bonding conductor and data cable

CAUTION

Damage to the interface modules possible

Cable shielding is not suitable for equipotential bonding.

Use only the prescribed equipotential bonding conductors. The equipotential bonding conductor ④ must have a minimum cross-section of 16 mm². The interface modules may otherwise be damaged or destroyed.

4.3.4 Connecting the Power Supply

Configuration graphic

The following figure shows the connection of the HMI device and the power supply.

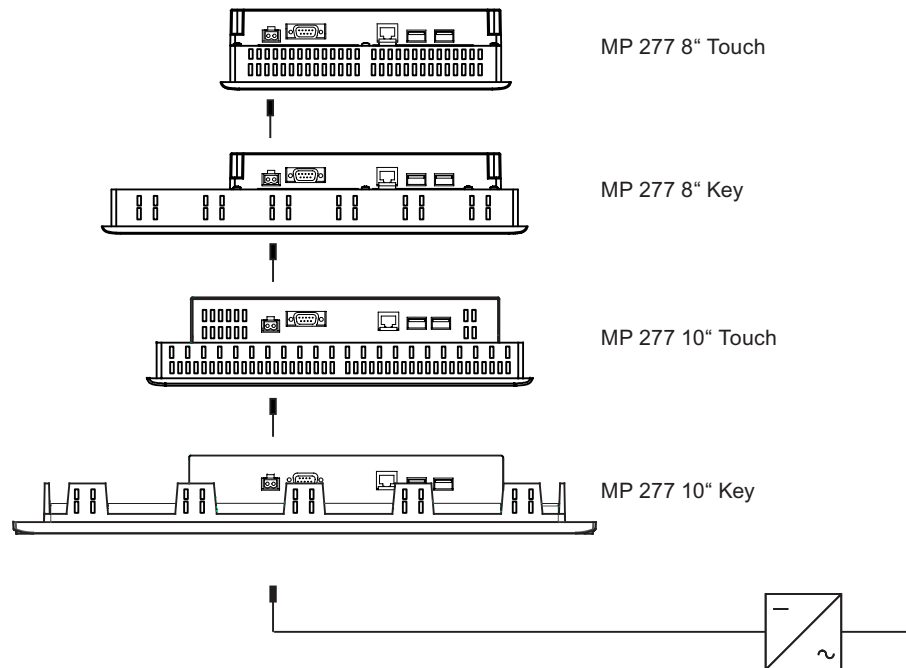

Note when connecting

The mains terminal for connecting the power supply is contained in the accessory kit. The mains terminal is designed for cables with a maximum cross-section of 1.5 mm².

Connecting the mains terminal

| |
|---|
| NOTICE |
| Damage Do not tighten the screws of the power supply terminal if it is plugged into the HMI device. The pressure from the screwdriver may otherwise damage the HMI device socket. Only connect the wires when the mains terminal is withdrawn. |

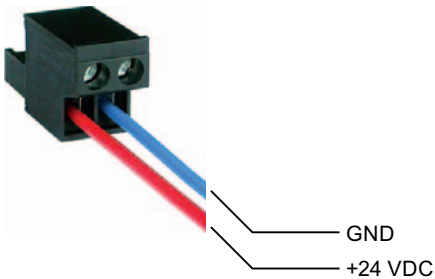

Connect the power supply terminal to the cables of the power supply as shown in the figure above. Ensure that the lines are connected properly to the correct terminals. Refer to the label for the contact pins on the rear of the HMI device.

Reverse polarity protection

The HMI device is equipped with reverse polarity protection.

Connecting the power supply

| |
|---|
| CAUTION |
| Safe electrical isolation Use only 24 VDC power supply units with safe electrical isolation in accordance with IEC 60364-4-41 or HD 384.04.41 (VDE 0100, Part 410), for example, in accordance with the PELV standard. The supply voltage must be within the specified voltage range. Malfunctions in the HMI device may otherwise result. Applies to non-isolated system design: Connect the connection for GND 24 V from the 24 V power supply output to equipotential bonding for uniform reference potential. You should always select a central point of termination. |

See also

Ports (Page 50)

4.3.5 Connecting the PLC

Configuration graphic

The following figure shows the connection of the HMI device and the controller.

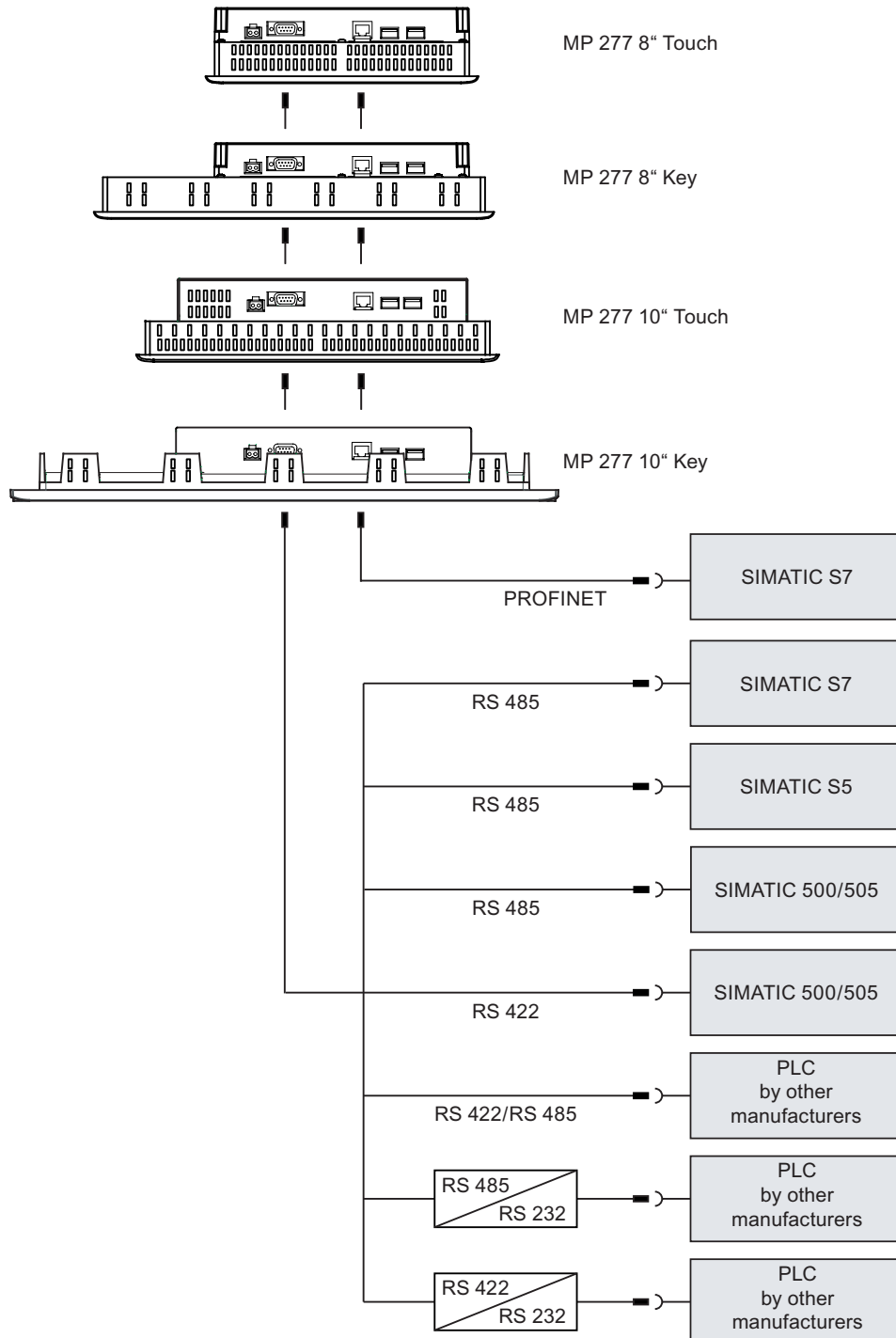

| |
|---------------|
| NOTICE |
|---------------|

| |
|--|
| Use only the approved cables to connect a SIMATIC S7 controller. |
|--|

Standard cables are available for the connection. You can find additional information on this in the Internet at "<http://mall.automation.siemens.com>".

Connecting PROFINET

| |
|---------------|
| NOTICE |
|---------------|

| |
|---|
| Use a cross-cable for the PROFINET connection when using a point-to-point connection. |
|---|

| |
|---------------|
| NOTICE |
|---------------|

| |
|--------------------|
| PROFINET IO |
|--------------------|

| |
|--|
| If you use PROFINET IO direct keys, the HMI device must be connected with a switch. For detailed instructions regarding the installation of PROFINET networks, please refer to the PROFINET system description manual. |
|--|

Only connect the HMI device to public Ethernet networks using a switch or comparable device.

Configuring an RS-422/RS-485 interface

A DIP switch for the configuration of the RS-422/RS-485 interface is located on the back of the HMI device.

In the factory state, the DIP switch is set for communication with the SIMATIC S7 PLC via RS 485.

Note

Note the diagrams of DIP switch settings on the rear panel of the HMI device.

The following table shows the DIP switch settings. The send and receive direction is toggled internally by the RTS signal.

| Communication | Switch setting | Meaning |
|---------------|--|--|
| RS 485 | <div style="text-align: center;">4 3 2 1</div> | No RTS on plug, for data transfer between PLC and HMI device (factory state) |
| | <div style="text-align: center;">4 3 2 1</div> | RTS on pin 4, same as PLC, for example for commissioning |
| | <div style="text-align: center;">4 3 2 1</div> | RTS on pin 9, same as programming device, for commissioning, for example |
| RS 422 | <div style="text-align: center;">4 3 2 1</div> | RS-422 interface is active. |

See also

Ports (Page 50)

Accessories (Page 23)

4.3.6 Connecting a Configuring PC

Configuration graphic

The following figure shows the connection of the HMI device and the configuration PC.

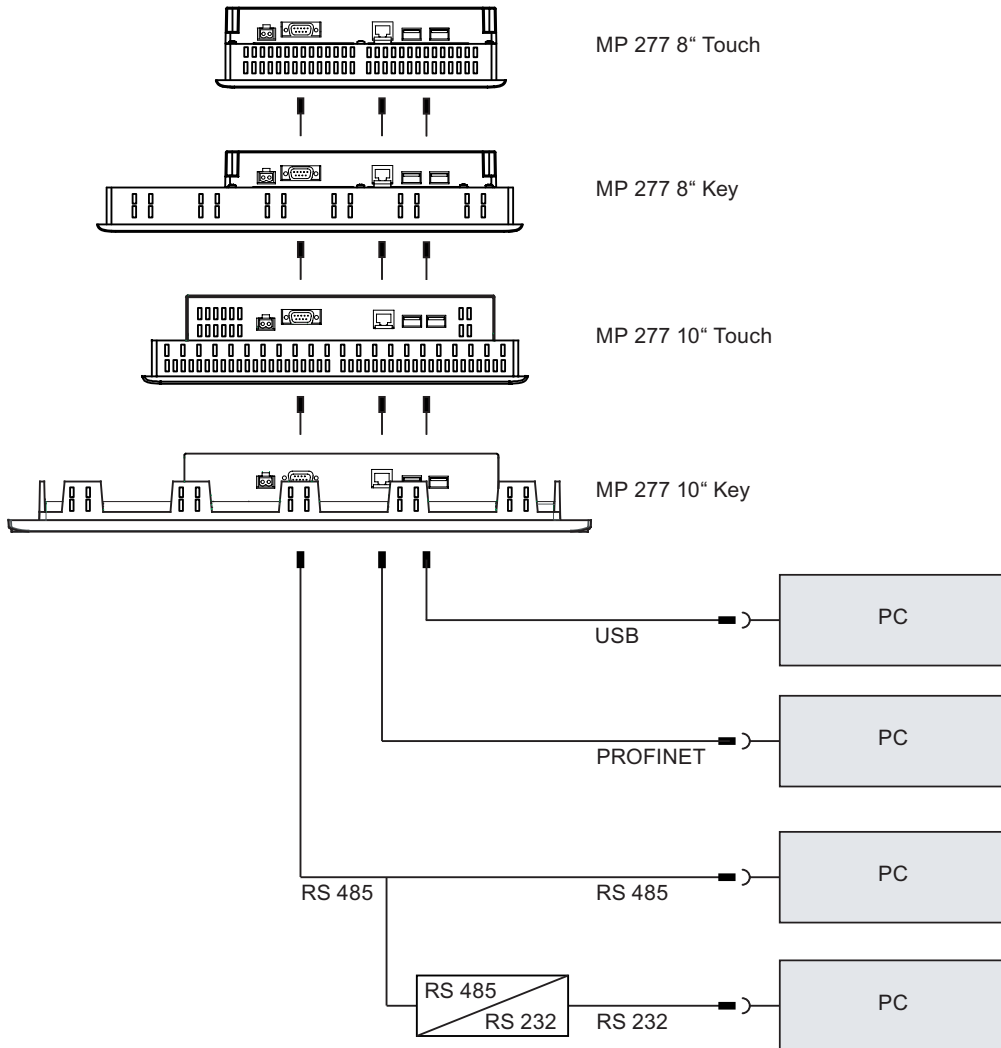

Use a cross-cable for the PROFINET connection when using a point-to-point connection.

The interfaces are described in the specifications.

For RS-485-RS-232 conversion, you can order the PC/PPI cable from Siemens AG.

Configuring the PC/PPI cable

Use the DIP switches to configure the transfer rate of the PC/PPI cable.

Note

Set a lower bit rate if the connection is lost during the operating system update. If you use a high bit rates, you need to use PC/PPI cable version 3 or higher. The version code is printed on the cable ("E stand 3," for example, corresponds to version 3).

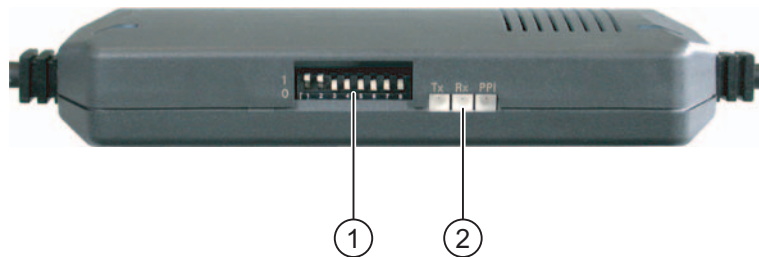

- ① DIP switch
- ② LEDs

Set the DIP switches 1 to 3 to the same value as in WinCC flexible. DIP switches 4 to 8 must be set to "0".



- ① DIP switch

The following bit rates can be set:

| Bit rate in kbps | DIP switch 1 | DIP switch 2 | DIP switch 3 |
|------------------|--------------|--------------|--------------|
| 115.2 | 1 | 1 | 0 |
| 57.6 | 1 | 1 | 1 |
| 38.4 | 0 | 0 | 0 |
| 19.2 | 0 | 0 | 1 |
| 9.6 | 0 | 1 | 0 |
| 4.8 | 0 | 1 | 1 |
| 2.4 | 1 | 0 | 0 |
| 1.2 | 1 | 0 | 1 |

In the figure, the bit rate is set to 115.2 kbps.

Note when connecting

| |
|---|
| NOTICE |
| USB connection sequence Observe the following sequence when connecting by USB: 1. HMI device 2. PC |
| USB host-to-host cable Use only the driver for the USB host-to-host cable that is included in the WinCC flexible package. Never use the driver supplied with the USB host-to-host cable. |
| Update operating system. If there is no serviceable HMI device image on the HMI device, you can only update the operating system by restoring the factory setting. Use the RS-422/485 interface with the PC/PPI cable on the HMI device. |
| Replacing the HMI device If you connect more than one HMI device with the same IP address in succession to a single configuration PC, you need to ping the configuration PC once from the HMI device on each time you replace the HMI device. |

See also

Accessories (Page 23)

Ports (Page 50)

4.3.7 Connecting a USB device

Note

Use only devices approved for connection to the HMI device.

The list of devices approved for connection to HMI devices via the USB port is available in the Internet at "<http://support.automation.siemens.com/WW/view/en/19188460>" and "<http://support.automation.siemens.com/WW/view/en/11376409>".

Below are examples of devices you can connect to the USB port of the HMI device:

- Mouse
- Keyboard
- Printer
- Industrial USB Hub 4
- USB memory devices
- Barcode reader

| |
|---|
| NOTICE |
| Malfunction from external device possible |
| If you connect external devices with their own power supply to the USB port and without using a non-insulated installation, you may experience functional problems. |
| If you wish to connect external devices with their own power supply to the USB port, ensure that the installation is non-isolated. |

| |
|--|
| NOTICE |
| Rated load of the interface |
| Malfunctions may occur on a USB device that presents an electrical overload on the port. |
| Adhere to the values for the maximum load on the USB port. |

See also

Connecting the Power Supply (Page 53)

X20, X21 (USB) (Page 261)

4.3.8 Connecting a Printer.

Configuration graphic

The following figure shows the connection of the HMI device and the printer.

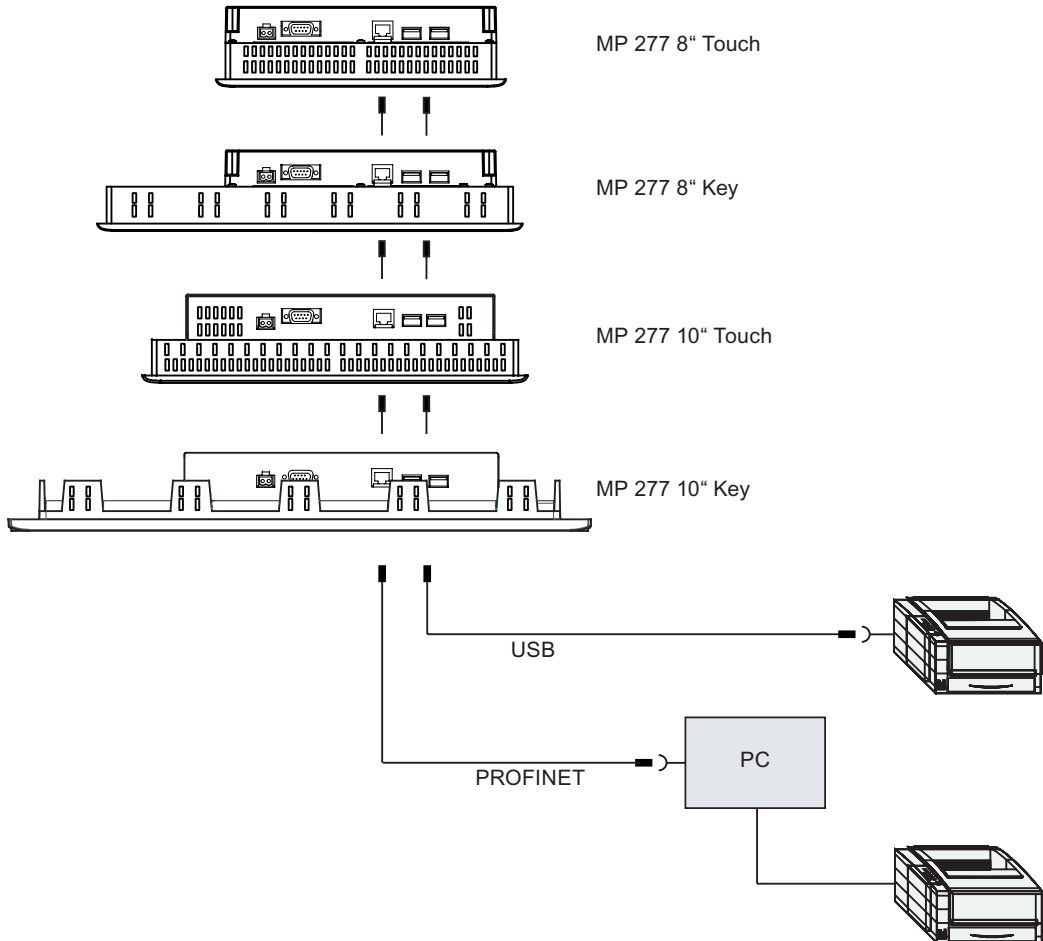

Note when connecting

NOTICE

Use only cables with metal-braided shielding grounded at both ends to connect the HMI device and printer.

Use a cross-cable for the Ethernet connection when using a point-to-point connection.

Some printers may require the ASCII character set used in the project to also be defined on the printer.

You can find the list of current printers and required settings for HMI devices in the Internet at "<http://support.automation.siemens.com/WW/view/en/11376409>".

Read the documentation supplied with the printer when connecting it.

See also

Ports (Page 50)

Connecting a USB device (Page 61)

4.4 Switching on and Testing the HMI device

Procedure

Proceed as follows:

1. Switching on the power supply.

The screen lights up after power is switched on. A progress bar is displayed during startup.

If the HMI device fails to start, you have probably crossed the wires on the mains terminal. Check the connected wires and change their connection. The Loader opens once the operating system has started.

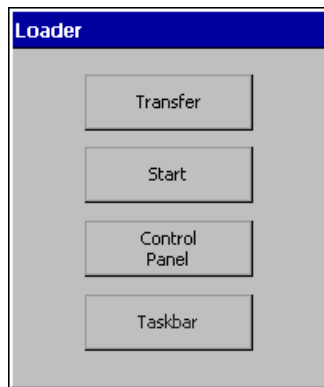

The HMI device automatically switches to "transfer" mode during initial startup under the following conditions:

- No project is loaded on the HMI device.
- At least one data channel has been configured.

During this process the following dialog appears:

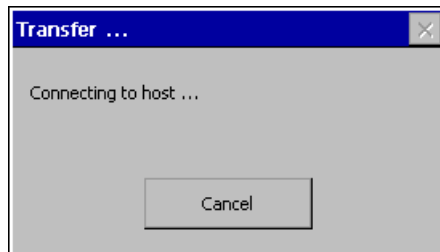

2. Press "Cancel" to stop the transfer.

Result

The Loader appears again.

Note

When restarting the system, a project may already be loaded on the HMI device. The system then skips "Transfer" mode and starts the project.

Use the relevant operator control to close the project.

Refer to your plant documentation to find any available additional information on this topic.

Function test

Perform a function test following commissioning. The HMI device is fully functional when one of the following states is indicated:

- The "Transfer" dialog is displayed.
- The loader is displayed.
- A project is started.

Shutting down the HMI device

Terminate the project at the HMI device before switching it off.

You have the following options for switching off the HMI device:

- Switch off the power supply.
- Remove the mains terminal from the HMI device.

4.5 Securing the cables

After the power-on test, to ensure strain relief, use cable ties to secure the connected cables to the marked fixing elements.



Operator controls and displays

5.1 Front operator controls

MP 277 Touch



- ① Display with touch screen

The assignment of the operator controls for the MP 277 8" Touch and the MP 277 10" Touch is basically the same.

You can operate the MP 277 Touch using the touch screen. All operator controls required for operator input are displayed on the touch screen once the HMI device has started.

MP 277 Key

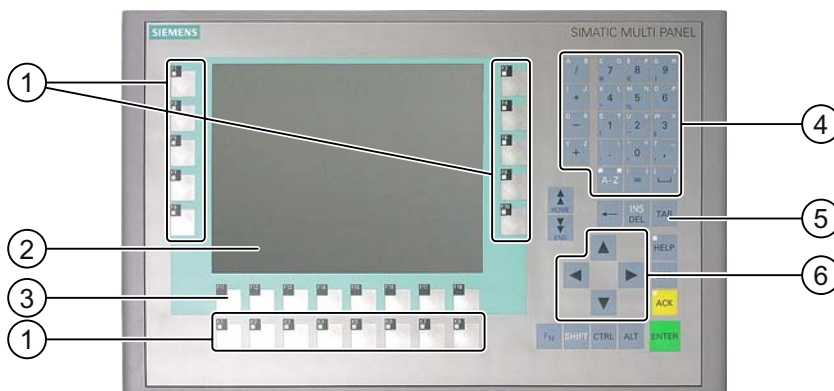

- ① Function keys with LED
- ② Display
- ③ Function keys without LED
- ④ System keys - alphanumeric keys
- ⑤ System keys - control keys
- ⑥ System keys - cursor keys

The assignment of the operator controls for the MP 277 8" Key and the MP 277 10" Key is basically the same.

The MP 277 Key is operated using the system keys and the function keys.

The function assigned to a specific function key is defined during configuration. The function keys have no function prior to the project being opened.

| |
|--|
| NOTICE |
| Unintentional action possible Do not carry out several operations simultaneously. You may otherwise trigger unintentional actions. <ul style="list-style-type: none">• Using the touch screen: Always touch only one operator control on the screen.• Using the keys: Do not press more than two keys simultaneously. |

| |
|---|
| NOTICE |
| Damage to the touch screen possible Never touch the touch screen with pointed or sharp objects. Avoid applying excessive pressure to the touch screen with hard objects. Both these will substantially reduce the useful life of the touch screen and even lead to total failure. Always operate the HMI touch screen with your fingers or with a touch pen. Damage to the keyboard Use only your fingers to operate the keys of your HMI device. Using hard instruments to press the keys considerably reduces the service life of the key mechanism. |

See also

Design of the HMI Device MP 277 8" Touch (Page 14)

Design of the HMI Device MP 277 8" Key (Page 16)

Design of the HMI Device MP 277 10" Touch (Page 18)

Design of the HMI Device MP 277 10" Key (Page 20)

5.2 Using Memory Cards with the HMI Device

Introduction

The following can be saved to the memory card of the HMI device:

- HMI device image (backup)
- Logs
- Recipes
- Operating system
- Applications
- Additional specifications

The memory card can be inserted and removed during operation. Do not remove the memory card while data is being accessed by an application, for example during backup or recipe transfer.

NOTICE

Multimedia card

The multimedia card of the SIMATIC S7 controller is not compatible with the HMI device.

Procedure – inserting a memory card

Proceed as follows:

Insert the memory card into the memory card slot.

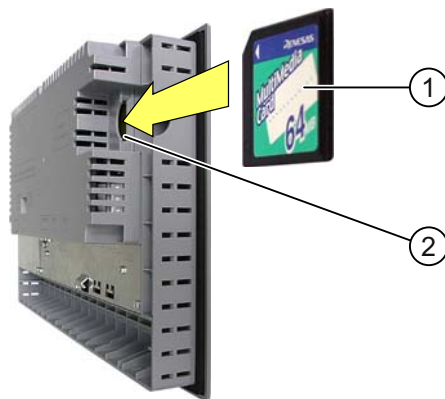

- ① Memory card
- ② Memory card slot

When inserting the memory card, please note that it can only be inserted as shown in the diagram. When the memory card is correctly inserted into the slot, it stands approx. 3 mm proud of the slot.

Using a memory card for the first time

| |
|---|
| NOTICE |
| Data loss The first time you use a memory card the HMI device will request that you format the card. Save a backup copy of memory card data to a PC beforehand. |

Proceed as follows in order to prevent data loss:

1. Cancel the formatting procedure by pressing "ESC".
2. Save a backup copy of vital data to a PC.
3. Format the memory card on the HMI device.
4. Transfer the backup data from the PC to the memory card.

You can now transfer the backup data from the memory card to the HMI device.

Procedure – removing a memory card

| |
|--|
| NOTICE |
| Data loss The data on the memory card may be lost if you attempt to remove it while the HMI device is accessing its data. Do not remove the memory card while data is being accessed. Observe the corresponding alarms on the screen. |

Proceed as follows:

1. Unplug the memory card from the memory card slot.
2. Store the memory card in a safe place.

5.3 Labeling the Function Keys at the MP 277 Key

Introduction

You can label the function keys as required for your project. Use the labeling strips for this purpose.

Note

Do not write on the keyboard to label the function keys.

Any printable and writable foil can be used as labeling strip. The permitted thickness of the labeling strip is 0.13 mm. Paper labeling strips are inappropriate.

You can use transparent foil, the keyboard membrane of the HMI device is printed on the reverse side. Use transparent foil so that the LEDs of the function keys can be seen.

Printing labeling strips

WinCC flexible comes with a range of labeling strip templates. You will find further information regarding the location of the templates in the WinCC flexible Online Help.

Dimensions of the labeling strip for the MP 277 8" Key

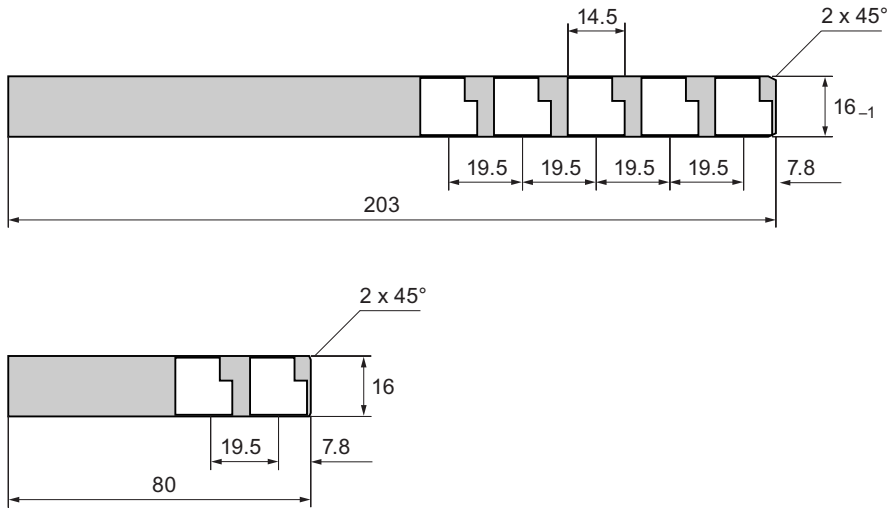

Dimensions of the labeling strip for the MP 277 10 inch Key

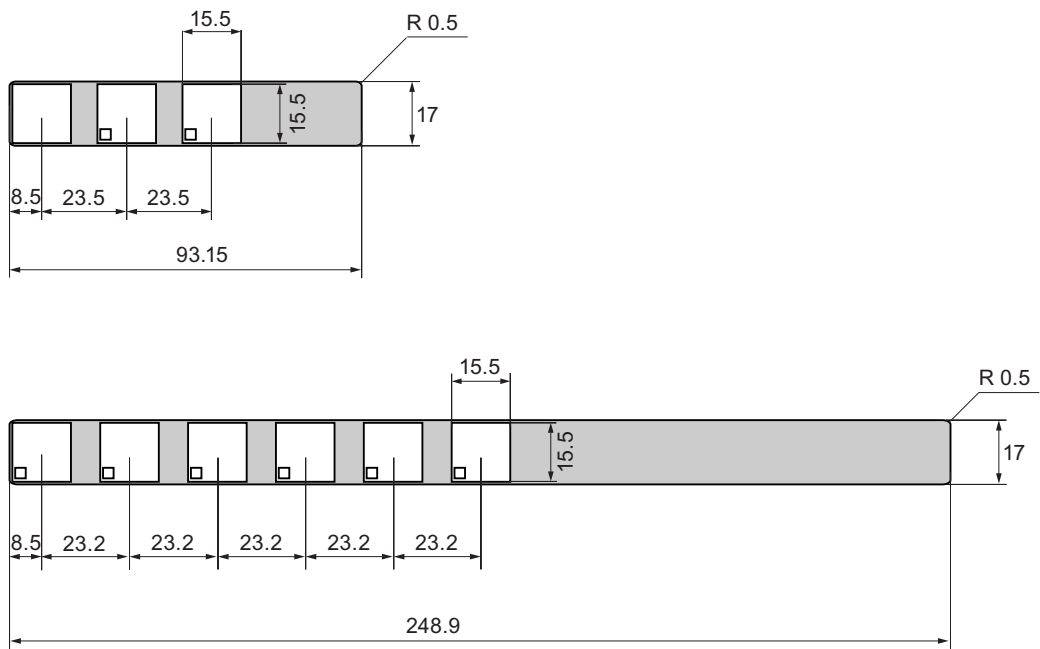

Procedure

Proceed as follows:

1. Edit the template and then it on the foil.
Another option is to print blank templates and later label them manually.
2. Apply a fixing spray to the labeling strips.
The fixing spray ensures that the text is water resistant and does not smear, and that the printer ink on the keyboard membrane does not run.
3. Cut out the labeling strip.
Ensure that the corners are cut according to the diagram shown above as this makes it easier to slide them into the slot.
4. Remove any existing labeling strips.

Note

Wait for the printed labeling strips to dry before you insert them.

5. Slide the labeling strips ② into the slot ①.



6. Slide the labeling strips into the slot up to the stop.
The labeling strip will protrude approximately 3 cm out of the slot. The template dimensions for the labeling strips are designed so that the labeling is correctly placed for the function keys. It is not necessary to secure the labeling strip.

When mounting the HMI device, ensure that the labeling strips do not become jammed between the mounting cut-out and the HMI device.

Configuring the operating system

6.1 Loader

Loader

The following figure shows the loader.

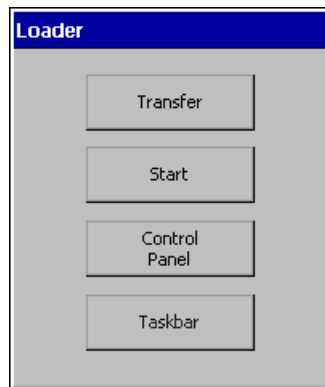

The loader buttons have the following functions:

- Press the "Transfer" button to set the HMI device to "Transfer" mode.
The transfer mode can only be activated when at least one data channel has been enabled for the transfer.
- Press the "Start" button to start the project on the HMI device.
If you do not perform an operation, the project on the HMI device will automatically start after a delay.

- Press the "Control Panel" button to open the Control Panel of the HMI device.
You can change various settings in the Control Panel, for example, the transfer settings.
- Press the "Taskbar" button to activate the taskbar with opened Windows CE Start menu:

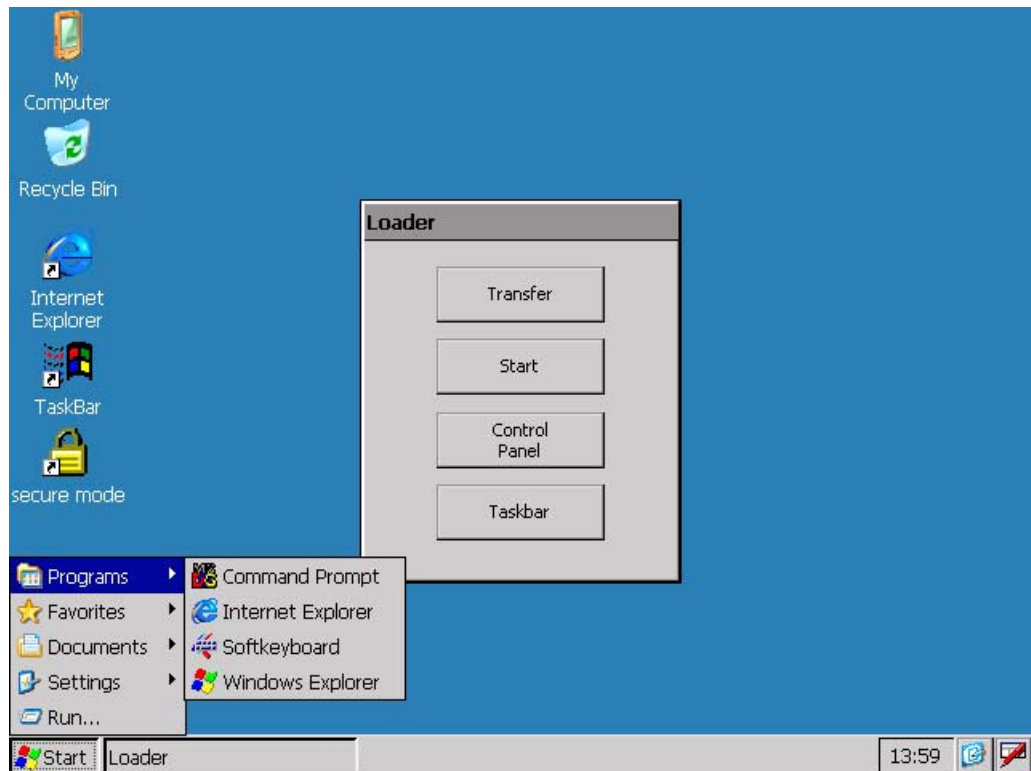

Open loader

The following options are available to open the loader:





- The loader appears briefly after starting the HMI device.
- The loader appears when the project is closed.

If configured, use the relevant operator control to close the project.

Refer to your plant documentation to find any available additional information on this topic.

Key operation in the loader

The following table shows the key combinations for navigating in the loader.

| Key combination | Function |
|---|---|
|  ,  ,  | The next or previous entry is selected. |
|  | The selected button is operated. |

Protection against unauthorized use

You can protect the control panel against unauthorized access by using a password.

You can also protect the taskbar and the Desktop with the help of SecureMode. If the HMI device is protected, "secure mode" is displayed on the Windows CE desktop. You can find additional information on this in the section "Setting up and disabling SecureMode (Page 77)".

The "Transfer" and "Start" buttons can always be used without having to enter a password.

Password protection prevents maloperation. This increases the security of the system or equipment because settings for the current project can only be changed after entering the password.

NOTICE

Loss of data possible

If the password is no longer available, you can only cancel password protection by updating the operating system. All data on the HMI device will be deleted when you update the operating system.

Back up the HMI device's data.

Pocket Internet Explorer

The Pocket Internet Explorer is installed on the HMI device.



Welcome to Microsoft Pocket Internet Explorer



© 2004 Microsoft Corporation. All rights reserved. [Terms of use.](#)

Note

The Pocket Internet Explorer and the PC version of the Internet Explorer differ in terms of functional range.

Internet Explorer for Windows CE has separate proxy settings that are independent of the settings in the control panel of the HMI device.

You can find additional information at the Microsoft's website.

Key operation in the user interface

The following table shows the key combinations for navigating in the user interface.

| Key combination | Function |
|-----------------|--|
| CTRL + ESC | The task bar is activated with the open Windows CE start menu. |
| ALT + ESC | The next active program is displayed. |
| ALT + TAB | The Task Manager is opened. |

Key operation in the Explorer

The following table shows the key combinations for navigating in the Explorer.

| Key combination | Function |
|-----------------------|--|
| TAB | <ul style="list-style-type: none"> Toggles the active window. Toggles between the Windows CE Desktop and the window. |
| F _N + HOME | Selects the first entry. |
| F _N + END | Selects the last entry. |
| CTRL + A-Z | Selects everything, if the left LED of the key A-Z lights up |
| ALT | Activates the menu bar. |
| ← | Changes to the higher level. |
| ALT + CTRL | Opens the shortcut menu. |
| ALT + ENTER | Displays the properties. |

See also

Switching on and Testing the HMI device (Page 63)

Configuring the data channel (Page 115)

Changing Password Protection (Page 94)

6.2 Setting up and disabling SecureMode

Overview

You can protect the control panel against unauthorized access with a password. You can also protect the taskbar and the Desktop with the help of the SecureMode.

Function of SecureMode

You set up SecureMode by setting up a password in the control panel. SecureMode is then automatically activated. The label "secure mode" is displayed in the Windows CE Desktop.

If you now want to use a function on the taskbar or Desktop, you have to enter the password. When you have entered the password, the label "secure mode" is no longer displayed. All the functions of the taskbar and Desktop can now be used freely. To reactivate SecureMode, double-click the  icon on the Desktop. The "secure mode" label is displayed again. The HMI device is protected again.

Canceling SecureMode

To completely cancel SecureMode, delete the password.

6.3 Control Panel

6.3.1 Overview

Control Panel of the HMI device



You can configure the following settings in the Control Panel of the HMI device:

- Date/time
- Screen saver
- Regional settings
- Transfer settings
- Network settings
- Delay time
- Password



Opening the Control Panel

The Control Panel can be opened as follows:

- In the startup phase
Press "Control Panel" to open the HMI device Control Panel in the Loader.
- In a running project
Operate the operating element provided for the respective task, if configured.

Alternatively you can open the Control Panel from the Windows CE start menu.









1. Open the Windows CE start menu.













- For HMI devices with key operation use the key combination  + 
- For HMI devices with touch operation, select the key  on the alphanumeric screen keyboard twice.

2. Open the Control Panel with "Settings > Control Panel".

6.3.2 Reference for functions

The following table shows the settings in the Control Panel.

| Symbol | Function |
|---|--|
|  | Saving to external storage device (backup) (Page 131) Restoring from external storage device (Page 133) |
|  | Importing and Deleting Certificates (Page 129) |
|  | Setting the Date and Time (Page 95) |
|  | Configuring the Screen Keyboard (Page 88) |
|  | Changing General Internet Settings (Page 126) |
| | Setting the Proxy Server (Page 127) |
| | Changing Privacy Settings (Page 128) |
|  | Setting the Character Repetition of the Keyboard (Page 89) |
|  | Setting the Double-click (Page 91) |
|  | Changing the Network Configuration (Page 122) |
| | <ul style="list-style-type: none"> • IP address • Name server |
|  | Changing the Logon Data (Page 124) |

| Symbol | Function |
|---|--|
|  | Backing up Registry Information (Page 98) |
| | Changing monitor settings (Page 99) |
| | Displaying Information about the HMI Device (Page 106) |
| | Restarting the HMI Device (Page 105) |
| | Calibrating the Touch Screen (Page 92) ¹⁾ |
| | Activate Memory Management (Page 136) |
|  | Changing Password Protection (Page 94) |
|  | Changing the Printer Properties (Page 102) |
|  | Enabling PROFINET IO (Page 117) |
|  | Changing Regional Settings (Page 97) <ul style="list-style-type: none"> • Number format • Currency • Time format • Date format |
|  | Changing S7 transfer settings (Page 112) |
|  | Setting the screen saver (Page 100) <ul style="list-style-type: none"> • Screen saver • Reducing screen backlighting |
|  | Displaying System Properties (Page 107) |
| | Setting the device name of the HMI device (Page 121) |
|  | Configuring the data channel (Page 115) |
| | Setting the Delay Time (Page 108) |
|  | Setting the uninterruptible power supply (Page 109) |
| | State of uninterruptible power supply (Page 111) |
|  | Set the volume (Page 103) |
|  | Changing E-Mail Settings (Page 125) ²⁾ |

1) Only with MP 277 Touch

2) The "WinCC flexible Internet Settings" tab can contain additional tabs. This depends on the options that have been enabled for network operation in the project.

6.3.3 Operating the Control Panel

6.3.3.1 Overview

Operator input options

The hardware of the HMI device determines which of the following operator control options are available:

- Touch screen

The operating elements shown in the dialogs are touch-sensitive. Touch objects are basically operated in the same way as mechanical keys. You activate operating elements by touching them with your finger. To double-click them, touch an operating element twice in succession.

- HMI device keyboard

The operating elements shown in the dialogs are selected and operated using the keys of the HMI device.

- External USB keyboard
- External USB mouse

Entries using an external keyboard

An external keyboard can be used to operate the Control Panel in exactly the same way as the HMI device keyboard. Use the keys of the external keyboard which correspond to the HMI device keys in the description.

Operator entries using an external mouse

An external mouse can be used to operate the Control Panel in exactly the same way as the HMI device touch screen. Click the described operating elements with the mouse.



6.3.3.2 Input with the Touch Screen

Introduction

The Control Panel is operated with the HMI device touch screen.

Procedure



Proceed as follows to change settings in the Control Panel:

1. Close the project.
Use the provided operating element.
The Loader appears.
2. Open the Control Panel by pressing the "Control Panel" button.
3. To open the required dialog, double-click its symbol.
4. Change as required by touching the tab.
5. Now make the necessary changes.
Touch the respective input object to make entries.
 - Use the screen keyboard of the HMI device to enter the new values in the text boxes.
 - Touch a button to operate it.
 - Touch the selection box to open a drop down list box. Touch the required entry from the drop down list box.
 - Touch the check box to activate or deactivate a check box.
 - Touch a radio button to select it.
6. Confirm the selection with the  button or abort the entry with the  button.
The dialog closes.
7. Close the Control Panel with the  button.
8. Start the project by pressing the "Start" button in the Loader.

Input with the screen keyboard

A screen keyboard is available for data input. The screen keyboard is displayed as soon as you touch a text box. You can also call up the screen keyboard directly from the Control Panel.

Display methods for the screen keyboard

You can change the display method for the screen keyboard and the position on the screen can be fixed. Confirm the entry with the  button or abort the entry with the  key. Either action closes the screen keyboard.

- Numerical screen keyboard



- Alphanumerical screen keyboard









The alphanumerical screen keyboard has various levels.

- Normal level
- Shift level
- Reduced screen keyboard



Changing the display of the screen keyboard

| Key | Function |
|---|--|
|  | Switching between the numerical and alphanumerical keyboard |
|  | Switching between the normal level and Shift level of the alphanumerical screen keyboard |
|  | Activation and deactivation of the numerical and alphanumerical keys of the alphanumerical screen keyboard |
|  | Switching from full display to reduced display |
|  | Switching from reduced display to full display |
|  | Closing of reduced display of the screen keyboard |

Moving the screen keyboard

In order to move the screen keyboard, proceed as follows:

Touch the  symbol.

1. Touch and move the screen keyboard on the touch screen.

Release the  symbol when the required position is reached.

See also

Configuring the Screen Keyboard (Page 88)

Entering and Editing Numerical Values (Page 167)

Entering and editing alphanumeric values (Page 170)

Front operator controls (Page 65)

6.3.3.3 Input with the Keyboard

Introduction

The Control Panel is operated with the system keys of the HMI device.

Procedure

Proceed as follows to change settings in the Control Panel:

1. Close the project.

Use the provided operator control.

2. Open the Control Panel.

The loader is displayed.

- Select the "Control Panel" button in the loader using the cursor keys.

- Press .













The Control Panel is opened.

3. Select the symbol of the required dialog with the cursor keys.

4. Press  to open the dialog.

5. Change the tab as required.







Press  until the name of the tab is selected. Now switch to the other tabs using the cursor keys.

6. Press  to return to the input area and make the necessary changes.
- Select the respective input object by pressing the  key to make entries.
- Use the system keys of the HMI device to enter the new values in the text boxes.
 - To operate a button, select the button with the cursor keys and then press .
 - Open the selection lists with the key combination  + .
- Select the required entry from the selection list using the cursor keys.
- Confirm the selected entry by pressing .
- Press  to activate or deactivate a check box.
 - Select a option button of a group using the cursor keys.
7. Confirm your entries with  or discard your entries with .
- If you have selected an input object, you first have to complete entry.
The dialog box closes.
8. Close the Control Panel.
- Press . This opens the Control Panel menu.
- Select the "Close" entry using the cursor keys.
 - Press .
- The loader is displayed.
9. Start the project.
- Select the "Start" button in the loader using the cursor keys.
 - Press .
- The project is started.











Control keys

The tables below show the control keys used to operate the Control Panel.





Select operator controls

| Key | Function | Description |
|--|-------------|---|
|   | Tabulator | Selects the next/previous operator control in the tab sequence. |
|     | Cursor keys | Selects the next operator control to the left, right, above or below the current screen object. Navigates in the operator control. |

Using operator controls

| Key | Function | Description |
|---|-------------------------|---|
|  | Scroll back | Scrolls back a page in a list. |
|  | Scroll to the beginning | Scrolls to the beginning of a list. |
|  | Scroll forward | Scrolls one page forward in a list. |
|  | Scroll to the end | Scrolls to the end of a list. |
|  | Enter key | <ul style="list-style-type: none"> Operates a button. Accepts and ends an entry. |
|  | Cancel | <ul style="list-style-type: none"> Deletes the characters of a value entry and restores the original value. Closes the active dialog. |
|  | Delete characters | Deletes the character to the right of the current cursor position. |
|  | Delete characters | Deletes the character to the left of the current cursor position. |
|  | Open selection list | Opens a selection list. |
|  | Accept value | Accepts the selected value in the selection list without closing the list. |

Enter key combinations

| Key | Function | Purpose |
|---|--|--|
|  | Toggle key assignment | <p>Toggles the assignment for a key with multiple assignment.</p> <ul style="list-style-type: none"> No LED is lit: The number assignment is enabled. Pressing the button once toggles to letter assignment. An LED is lit: The left or right letter assignment is enabled. <p>Each time the key is pressed, the system toggles between the left letter assignment, the right letter assignment and the number assignment.</p> |
|  | Toggle between upper-case and lower-case | Used in key combinations, for example for entering upper-case letters. |
|  | Switch to additional key assignment | <p>Some of the keys contain a key assignment imprinted blue, for example the "%" character.</p> <p>Used in key combinations for the blue key assignment.</p> |
|  | General control function | Used in key combinations |
|  | General control function | Used in key combinations |

See also

Entering and editing numerical values (Page 178)

Entering and editing alphanumerical values (Page 179)

Front operator controls (Page 65)

6.4 Changing settings for operation

6.4.1 Configuring the Screen Keyboard

Introduction

You can change the layout and the position of the screen keyboard as follows.

Requirement

You have opened the "Siemens HMI InputPanel - Options" dialog by pressing the "InputPanel"  icon.

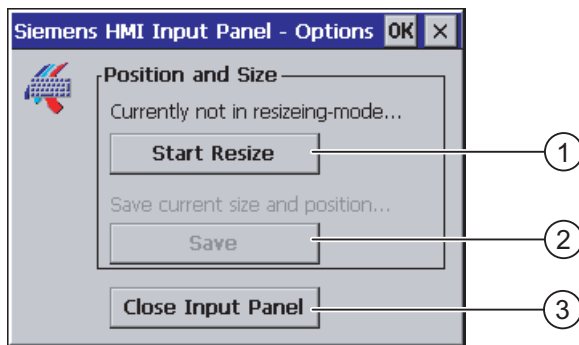

- ① Button for displaying the screen keyboard
- ② Button for saving the screen keyboard settings
- ③ Button for closing the screen keyboard

Procedure

Proceed as follows:

1. Display the screen keyboard by pressing the "Open Input Panel" button.
2. By pressing the  button, you can switch between the numerical and alphanumerical screen keyboard.
3. Set the position of the screen keyboard by moving the screen keyboard on the screen.
4. Save your settings by pressing the "Save" button.
5. Close the screen keyboard by pressing the "Close Input Panel" button.
6. Close the dialog.

Result

The screen keyboard settings have been modified.

See also

Input with the Touch Screen (Page 82)

6.4.2 Setting the Character Repetition of the Keyboard

Introduction

You can set the character repeat for the keyboard or screen keyboard in the Control Panel.

Requirement

You have opened the "Keyboard Properties" dialog box by pressing the "Keyboard"  icon.

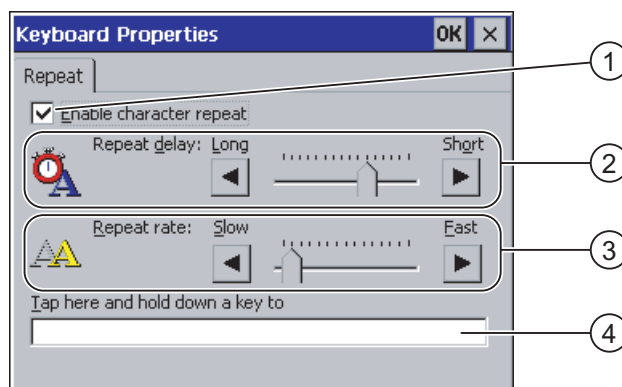

- ① Check box for activating the character repeat
- ② Slider control and buttons for the delay time before character repeat
- ③ Slider control and buttons for the rate of the character repeat
- ④ Test field

Procedure

Proceed as follows:

1. Select the "Enable character repeat" check box to enable the character repeat.
2. Use the buttons to set the delay and rate of the character repeat. You can also use the slider control for this.
3. Verify your settings.

For HMI devices with touch operation.

- Touch the test field. The screen keyboard opens.
- Move the screen keyboard as needed.
- Touch any character and keep it pressed.
- Check the implementation of the character repetition and the rate of the character repetition in the test field.
- Correct your setting if necessary.

For HMI devices with key operation.

- Select the test field.
- Press an alphanumeric key and keep the key pressed down.
- Check the implementation of the character repetition and the rate of the character repetition in the test field.
- Correct your setting if necessary.

4. Confirm your entries.

The dialog box closes.

Result

The character repeat for the keyboard is now set.

6.4.3 Setting the Double-click

Introduction

You can start applications in the Control Panel and in Windows CE with a double-click. A double-click corresponds to two brief touches in sequence.

In the "Mouse Properties" dialog, make the following adjustments for touch screen operation and operation with external mouse:

- Interval between touch contacts on the touch screen
- Interval between mouse clicks

Requirement

You have opened the "Mouse Properties" dialog with the "Mouse"  icon.

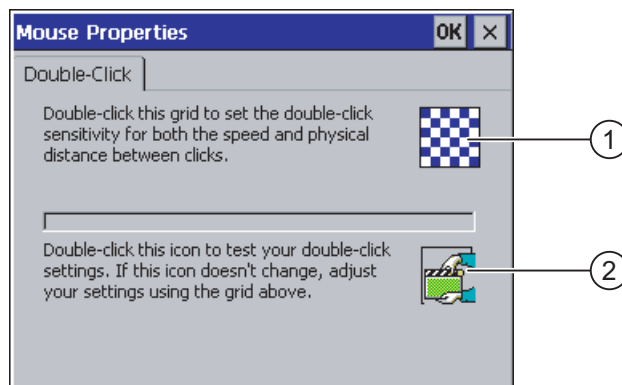

- ① Pattern
- ② Symbol

Procedure

Proceed as follows:

1. Double-click the pattern twice.

After one double-click, the pattern is shown in inverse colors.



2. Double-click the symbol twice.

If the double-click is valid, the symbol is displayed as follows:



3. If the symbol remains unchanged, double-click on the pattern again.
4. Confirm your entries.

The dialog box closes.

Result

The double-click adjustment is completed.

6.4.4 Calibrating the Touch Screen

Introduction

Depending on the mounting position and viewing angle, it is possible that parallax may occur when operating the touch screen. In order to prevent any operating errors as a result, calibrate the touch screen again in the startup phase or during runtime.

Requirements

You have opened the "Touch" tab in the "OP Properties" dialog box by pressing the "OP"  icon.

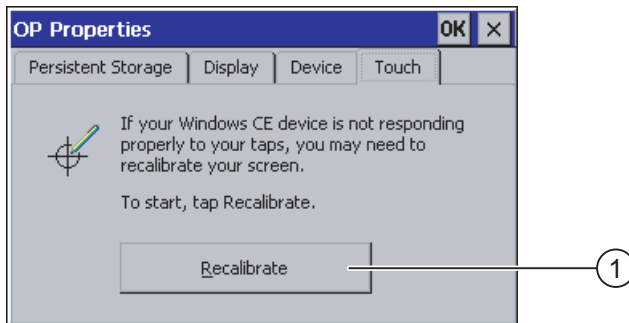

① Button for calibrating the touch screen

Procedure

Proceed as follows:

1. Touch the "Recalibrate" button to open the following dialog:

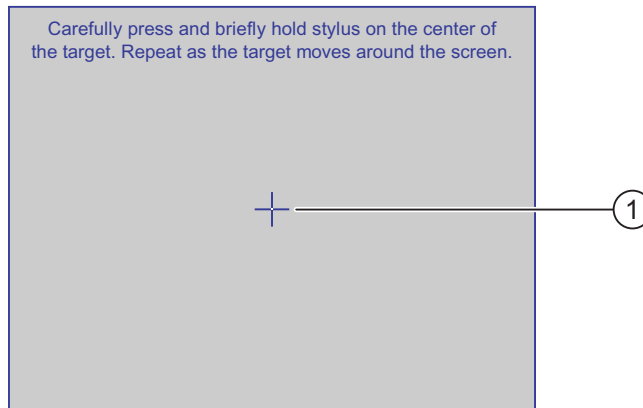

2. Briefly touch the middle of the calibration crosshairs ①.

The calibration crosshairs is then displayed at four more positions. Touch the middle of the calibration crosshairs for each position. If you do not touch the middle of the calibration crosshairs, the procedure is repeated.

Once you have touched the calibration crosshairs for all positions, the following dialog appears:

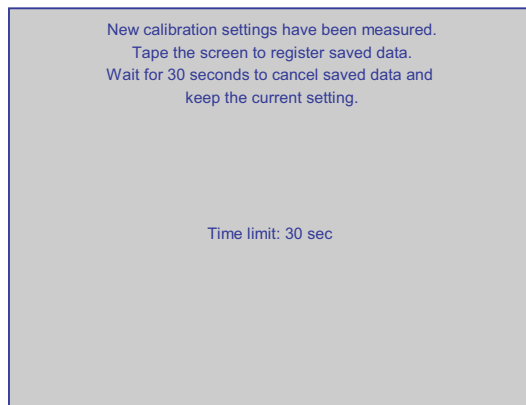

3. Touch the screen within 30 seconds.

The new calibration is saved. If you wait longer than 30 seconds, the new calibration is discarded and the original calibration remains in effect.

The "OP Properties" dialog, "Touch" tab is displayed again.

4. Close the dialog.

Result

The HMI device touch screen is now recalibrated.

6.5 Changing Password Protection

Introduction

You can protect the Control Panel and Windows CE taskbar with a password.

Requirements

You have opened the "Password Properties" dialog box by pressing the "Password"  icon.

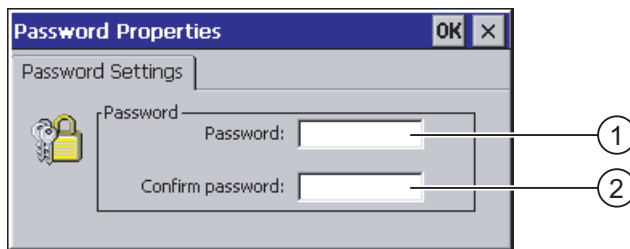

- ① Password text box
- ② Text box for entering the password a second time

NOTICE

If the password is no longer available, you cannot do the following until you have updated the operating system.

- Making changes to the Control Panel
- Operating the Windows CE task bar

All data on the HMI device will be overwritten when you update the operating system!

Procedure for activating password protection

Proceed as follows:

1. Enter a password in the "Password" text box.
2. Repeat the password entry in the "Confirm Password" text box.
3. Confirm your entries.

The dialog closes.

NOTICE

The following characters cannot be used in passwords:

- Blank
- Special characters * ? . % / \ ' "

Result

You cannot open the Control Panel or Windows CE taskbar without entering a password.

Procedure for deactivating password protection

Proceed as follows:

1. Delete the entries in the "Password" and "Confirm password" text boxes.
2. Confirm your entries.

The dialog closes.

Result

Password protection for the Control Panel and Windows CE taskbar is disabled.

6.6 Changing HMI device settings

6.6.1 Setting the Date and Time

Introduction

You can set the date and time on the HMI device. The HMI must be restarted in the following cases:

- You have changed the time zone setting.
- You have changed the setting of the "Daylight savings time currently in effect" check box .

Requirement

You have opened the "Date/Time Properties" dialog box by pressing the "Date/Time Properties"  icon.

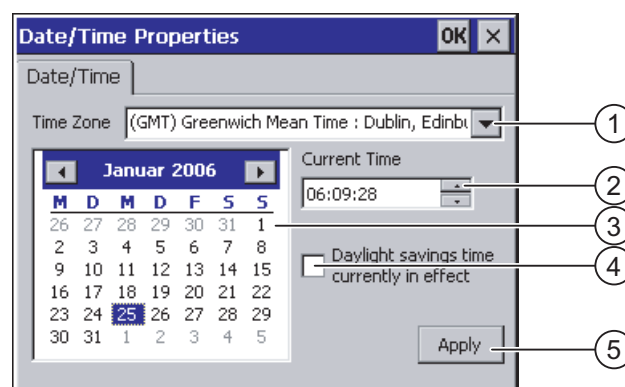

- ① Time zone
- ② Time
- ③ Date
- ④ "Daylight savings" check box
- ⑤ Button for applying changes

Procedure

Proceed as follows:

1. Select the appropriate time zone for the HMI device in the "Time Zone" selection box.
2. Touch the "Apply" button to confirm your entry.
The time of day shown in the "Current Time" field is adjusted correspondingly to the selected time zone.
3. Set the date in the selection box.
4. Set the current time of day in the "Current Time" text box.

Note

The system does not automatically switch between standard time and daylight saving time.

5. If you want to switch from standard time to daylight saving time, select the "Daylight saving time currently in effect" check box.
When you press the "Apply" button, the time is brought forward by one hour.
6. If you want to switch from daylight saving time to standard time, clear the "Daylight saving time currently in effect" check box.
When you press the "Apply" button, the time is brought back by one hour.
7. Confirm your entries.
The dialog box closes.

Result

The settings for the date and time of day have now been changed.

Synchronizing the date and time with the PLC

The date and time of the HMI device can be synchronized with the PLC if this has been configured in the project and the PLC program.

You can find additional information on this subject in the "WinCC flexible" system manual.

| |
|---------------|
| NOTICE |
|---------------|

| |
|--|
| You have to synchronize the date and time when time-controlled responses are triggered in the PLC by the HMI device. |
|--|

See also

Restarting the HMI Device (Page 105)

6.6.2 Changing Regional Settings

Introduction

In different countries, for example, the date, time and decimal points are displayed differently. You can adjust the display format to meet the requirements of different regions.

The country-specific settings apply to the current project. If the project language is changed, the country-specific settings are also changed.

Requirements

You have opened the "Regional and Language Settings" dialog box by pressing the "Regional Settings"  icon.

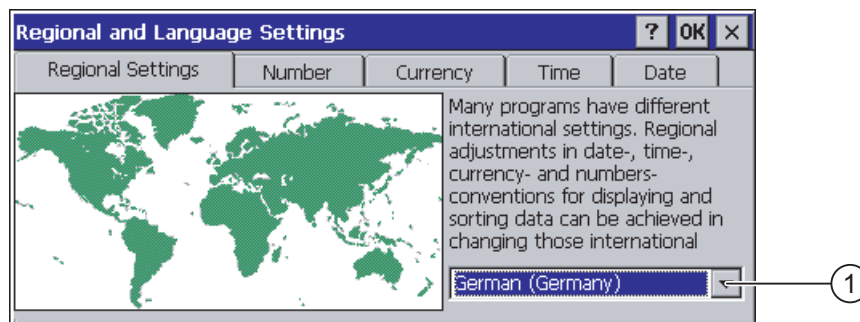

① Region selection box

Procedure

Proceed as follows:

1. Select the region from the selection box.
2. Change to the "Number", "Currency", "Time" and "Date" tabs and set the selection boxes to the desired settings.
3. Confirm your entries.

The dialog closes.

Result

The HMI device's regional settings have been changed.

6.6.3 Backing up Registry Information

Registry information and temporary data

You can install and uninstall your own programs on the HMI devices under Windows CE. You must save the registry settings after installation or uninstallation.

You can save the following data to the flash memory:

- Registry Information
- Temporary files

Restoring the file system of a memory card

If memory cards are used, the file system on the memory card may become damaged, perhaps due to a power failure. The HMI device detects the defective file system on start-up or when the memory card is inserted. The HMI device can restore the file system automatically or on request.

Requirements

You have opened the "Persistent Storage" tab in the "OP Properties" dialog box by pressing the "OP"  icon.

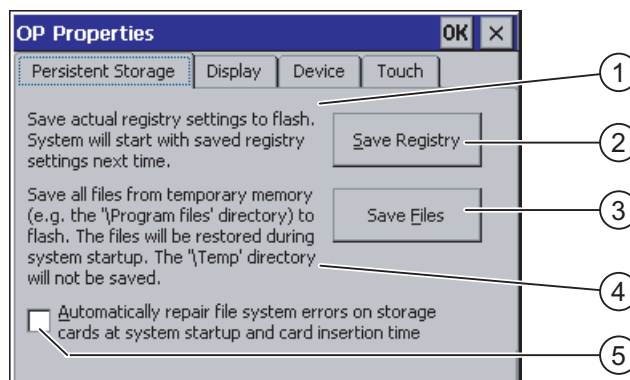

- ① Meaning of the text in the dialog:
Saves the current registry information to the flash memory. The HMI device loads the saved registry information the next time it boots.
- ② Button for saving registry information
- ③ Button for saving temporary files
- ④ Meaning of the text in the dialog:
Saves all the files in temporary storage to the flash memory (for example, from the "Program Files" directory). These files are written back when the HMI device is started. The "\Temp" directory is not saved.
- ⑤ Check box for automatically restoring the file system on the memory card when the HMI device starts up and when a memory card is inserted.

Procedure

Proceed as follows:

1. Select the "Save Registry" button to save the current registry settings.
2. Select the "Save Files" button to save temporary files.
3. Specify how the file system on the memory card should be restored.
 - Activate the check box "Automatically Repair ..." to activate automatic restore.
 - Deactivate the check box "Automatically Repair ..." if you wish to have the files system restored only upon prompting.
4. Confirm your entries.

The dialog closes.

Result

The HMI device uses the saved registry information the next time it starts. The temporary files are copied back.

6.6.4 Changing monitor settings

Requirements

You have opened the "OP Properties", dialog "Display" tab with the "OP"  icon.

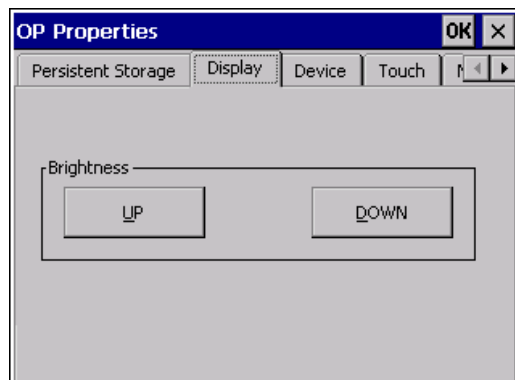

Procedure

Proceed as follows:

1. If you want to increase the brightness, press the "UP" button.
2. If you want to decrease the brightness, press the "DOWN" button.
3. Confirm your entries.

The dialog closes.

Result

The screen settings have been changed.

6.6.5 Setting the screen saver

Introduction

You can set the following time intervals on the HMI device:

- For the automatic activation of the screen saver
- For the automatic reduction in the screen's backlighting

When you do not undertake an operation within the configured interval, the configured function will be activated automatically.

The screen saver and the reduced screen backlighting functions are switched back off by means of the following actions:

- By pressing any key
- By touching the touch screen

The function associated to the key or button will not be executed by this.

| |
|--|
| NOTICE |
| Deterioration of the backlight brightness The brightness of the backlighting decreases incrementally during its operational life. In order to increase the operational lifetime of the backlighting, activate the backlighting reduction. Burn-in effects The prolonged display of screen contents can occasionally lead to a burn-in effect in the background. This burn-in effect automatically disappears after a certain amount of time, for example, after the screensaver was activated. The longer the same content is displayed on the screen, the longer it will take for the burn-in effect to disappear. Generally, you should always activate the screen saver. When the screen saver is active, the backlighting is reduced at the same time. |

Requirements

You have opened the "Screensaver" dialog box by pressing the "ScreenSaver"  icon.

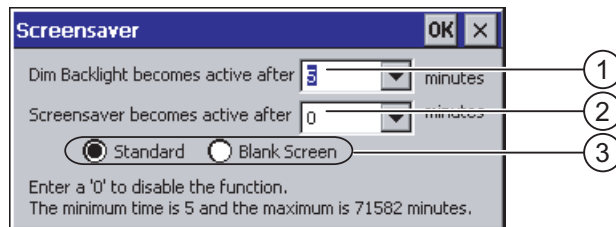

- ① Time interval in minutes until backlighting is reduced
- ② Period of time in minutes before the screen saver is activated
- ③ Screen saver setting

Procedure

Proceed as follows:

1. Enter the interval in minutes after which the backlighting is to be reduced.
Entering "0" will deactivate the backlighting reduction.
2. Enter the number of minutes before the screen saver is to be activated.
The minimum time is 5 minutes and the maximum time is 71582 minutes.
Entering "0" disables the screen saver.
3. Select either the standard screen saver or an empty screen.
 - In order to select the standard screen saver, activate the "Standard" option.
 - In order to select an empty screen as screen saver, activate the "Blank Screen" option.
4. Confirm your entries.
The dialog closes.

Result

The screen saver and the reduced backlighting for the HMI device is set.

6.6.6 Changing the Printer Properties

Introduction

HMI devices can print on local printers or network printers. You can print hardcopy and logs on network printers. Line printing of alarms is not possible on a network printer.

You can find the list of current printers and required settings for HMI devices in the Internet at "<http://support.automation.siemens.com/WW/view/en/11376409>".

Requirement

You have opened the "Printer Properties" dialog box by pressing the "Printer"  icon.

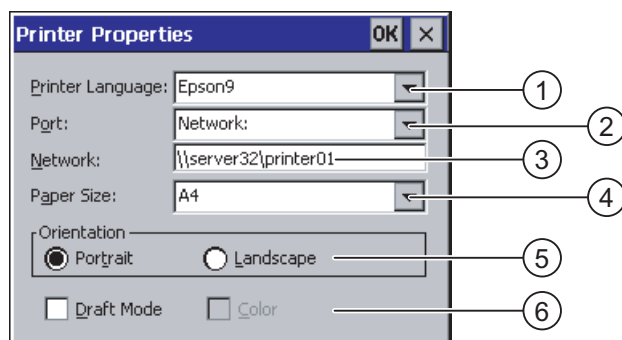

- ① Printer selection box
- ② Interface
- ③ Network address of the printer
- ④ Paper size selection box
- ⑤ Orientation setting
- ⑥ Print quality setting

Procedure

Proceed as follows:

1. Select the printer in the "Printer Language" selection box.
2. Select the port for the printer in the "Port" selection box.
3. If you wish to print via the network, enter "Network:" in the text box the network address of the printer.
4. Select the paper format in the "Paper Size" selection box.
5. Select the required option button in the "Orientation" group:
 - "Portrait" for vertical format
 - "Landscape" for horizontal format
6. Select the print quality.
 - Select the "Draft Mode" check box if you want to print a draft.
 - Clear the "Draft Mode" check box if you want to print with higher quality.

7. Set the color mode.
 - Select the check box "Color" if you wish to print in color.
8. Confirm your entries.

The dialog box closes.

Result

The settings for the printer have now been changed.

6.6.7 Set the volume

Introduction

You can activate an acoustic feedback for keyboard and touch screen operations. With each touch or activation of a key, an acoustic signal is emitted.

Requirements

You have opened the dialog "Volume & Sounds Properties" using the icon "Volume & Sounds" .

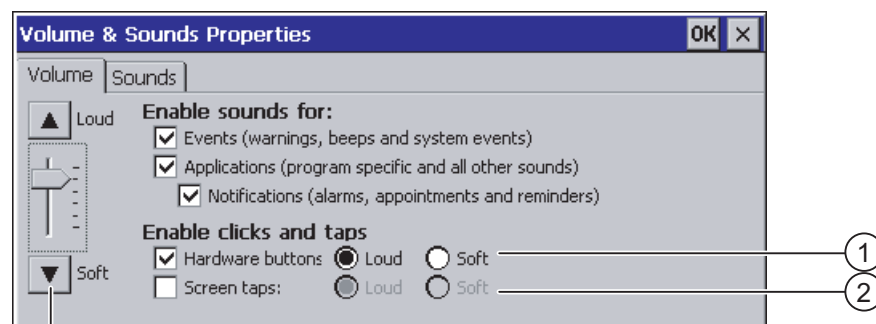

- ① Check boxes and radio buttons for acoustic feedback when using the keyboard
- ② Check boxes and radio buttons for acoustic feedback when using the touch screen
- ③ Buttons for adjusting the volume

Note

If you deactivate the settings under "Enable sounds for:" no more acoustic signals will be emitted during inadvertent operations.

Procedure

Proceed as follows:

1. For HMI devices with keys:
 - Click the check box "Hardware buttons" to activate the acoustic signal.
 - Choose between a loud and soft acoustic signal using the "Loud" and "Soft" radio buttons.
2. HMI devices with touch screen:
 - Activate the "Screen Taps" check box to activate the acoustic signal.
 - Choose between a loud and soft acoustic signal using the "Loud" and "Soft" radio buttons.
3. Choose the required volume using the "Loud" and "Soft" radio buttons.
4. Confirm your entries.

The dialog closes.

Note

The entries in the "Sounds" tab are of no relevance to the HMI device.

Result

The properties of the acoustic operation feedback are now set up.

See also

Overview (Page 161)

6.6.8 Restarting the HMI Device

Introduction

The HMI device must be restarted in the following cases:

- You have activated or deactivated the PROFINET IO direct keys
- You have changed the time zone setting.
- You have changed the automatic daylight savings and standard setting

| |
|--|
|  CAUTION |
| Data loss when the HMI device is restarted All volatile data is lost when the HMI device is rebooted. Check the following: <ul style="list-style-type: none">• The project on the HMI device is not open• No data is being written to the flash memory |

Requirements

You have opened the "OP Properties" dialog box by pressing the "OP" icon.

Procedure

1. Change to the "Device" tab in the "OP Properties" dialog.
2. Press "Reboot" to restart the HMI device.

A warning is displayed.

The HMI device reboots immediately if you confirm this warning.

Result

The HMI device starts.

See also

Enabling PROFINET IO (Page 117)

Setting the Date and Time (Page 95)

6.6.9 Displaying Information about the HMI Device

Introduction

You will need the device-specific information when you contact Technical Support.

Requirement

You have opened the "Device" tab in the "OP Properties" dialog box by pressing the "OP"  icon.

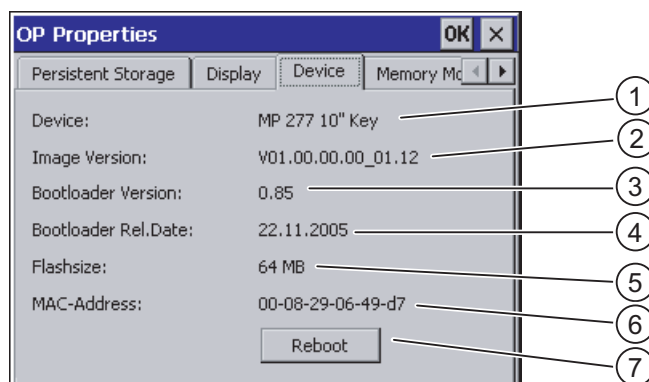

- ① HMI device name
- ② Version of the HMI device image
- ③ Version of the boot loader
- ④ Boot loader release date
- ⑤ Size of the internal flash memory in which the HMI device image and project are stored
- ⑥ MAC address of the HMI device
- ⑦ Button for restarting the HMI device

Dialog "OP Properties", tab "Device", example MP 277 10" Key

Procedure

Proceed as follows:

1. The device-specific information is displayed in the "Device" tab.
2. Close the dialog when the information is no longer required.

Note

The size of the internal flash memory does not correspond to the available working memory for a project.

6.6.10 Displaying System Properties

Introduction

The system-specific information provides you with information about the processor, operating system and memory of the HMI device.

Requirements

You have opened the "System Properties" dialog box by pressing the "System"  icon.

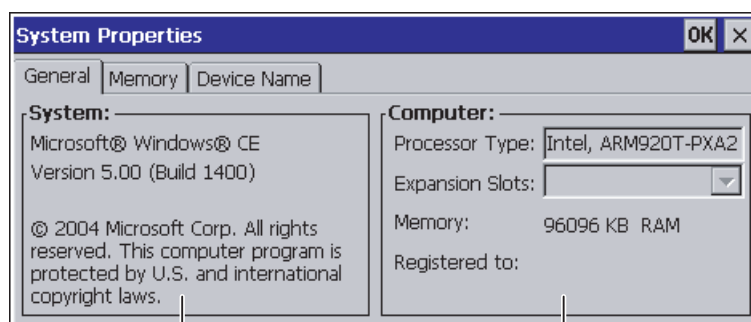

- ① Copyright to Microsoft Windows CE
- ② Information about the processor, size of the internal flash memory, and capacity of a memory card when inserted

Displaying the system information

The system information is displayed. This dialog is read-only.

Close the dialog.

Procedure for displaying memory information

NOTICE

"Memory" tab

Do not change the memory distribution in the "Memory" tab.

Only applies for the usage of options:

An alteration to the memory distribution may be necessary. Please refer to the accompanying documentation for further information.

Proceed as follows:

1. Change to the "Memory" tab.

The memory information is displayed.

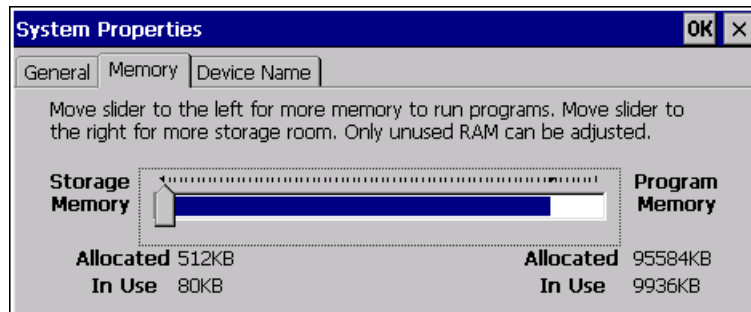

2. Close the dialog.

6.7 Setting the Delay Time

Introduction

The project is opened following a delay time when the HMI device is switched on. The Loader is displayed during the delay time.

Requirements

You have opened the "Directories" tab in the "Transfer Settings" dialog box by pressing the "Transfer"  icon.

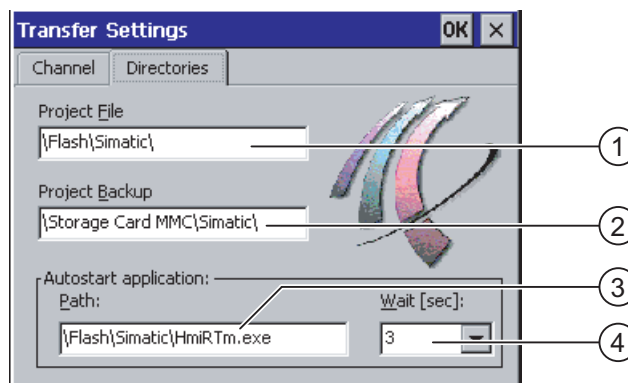

- ① Directory where the project file is saved
- ② Directory where the compressed source file of your project is saved
The external memory card or the network connection can be defined as the storage location. During the next backup process, the project's source file is stored in the specified location.
- ③ Storage location and initialization file of the HMI device for process operation
- ④ Region selection box

| |
|---------------|
| NOTICE |
|---------------|

| |
|--|
| Settings in "Project File" and "Path" |
|--|

| |
|---|
| Do not change the setting in the "Project File" and "Path" fields. The project may not open at the next start of the HMI device if changes are made here. |
|---|

Procedure for setting the delay time

1. Select the desired delay time in seconds in the "Wait [sec]" selection box.
With the value "0", the project starts immediately. It is then no longer possible to call the Loader after switching on the HMI device. If you still wish to access the Loader, an operating element must be configured to close the project.
2. Confirm your entries.
The dialog closes.

Result

The delay time for the HMI device is now set.

6.8 Setting the uninterruptible power supply

Introduction

UPS monitoring is an option you load as an add-on with ProSave.

A UPS ensures that the HMI device is shut down in a controlled manner after a buffer time in the event of a power failure. This avoids the loss of data.

The following uninterruptible power supplies are supported:

SITOP DC UPS modules as of a rated power value of 6 A, e.g. 6EP1931-2DC42

Connect the UPS to the 24-V input and a USB port. Configure the USB port for UPS monitoring.

Requirements

You have opened the "UPS Properties", dialog "Configuration" tab with the "UPS"  icon.

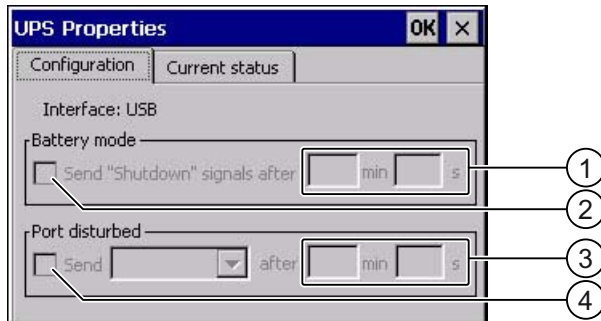

- ① Text box for the time after which the "Battery mode activated" message is displayed
- ② Check box for enabling battery mode
- ③ Text box for the time after which the "Faulty port" message is displayed
- ④ Check box for the "Faulty port" message

Procedure

Proceed as follows:

1. If you want to enable battery mode, activate the "Battery mode" check box.
2. Enter the time for terminating applications in the "min" and "s" text boxes.
You will receive a message when UPS takes effect. Applications such as HMI Runtime and WinAC MP are then terminated depending on the time entered.
3. If the port to which the UPS is connected is faulty and you therefore want to receive a message, activate the "Port disturbed" check box.
4. Select the message you want from the list box.
5. Enter the time after which the "Faulty port" message is displayed in the "min" and "s" text boxes.

Result

Port monitoring for the UPS is set.

6.9 State of uninterruptible power supply

Introduction

If you have connected a UPS to a USB port, you can display the monitoring state of this port.

Requirements

You have opened the "UPS Properties", dialog "Current status" tab with the "UPS"  icon.

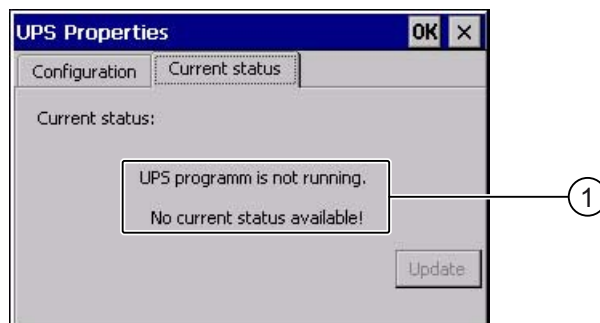

- ① The "UPS programm is not running. No current status available." message appears when the UPS is not connected.

Procedure

Proceed as follows:

1. Installing the UPS monitoring software.
2. Connect the UPS.
3. If you want to update the monitoring state, press the "Update" button.

The message is changed according to the current setting. The message will remain unchanged if no check boxes in the "Configuration" tab have been activated.

Result

The current monitoring state for the UPS is displayed.

6.10 Change the communication settings

6.10.1 Changing S7 transfer settings

Introduction

The communication settings between the HMI device and PLC are defined in the HMI device project. In the following cases, the communication settings might have to be changed:

- The first time the project is transferred
- If changes are made to the project but are only applied later

NOTICE

Transfer mode using MPI/PROFIBUS DP

The bus parameters are read from the project currently loaded on the HMI device.

You can change the settings for MPI / PROFIBUS DP transfer. The following steps are required:

- Close the project.
- Change the settings on the HMI device.
- Then return to "Transfer" mode.

The changed MP/PROFIBUS DP settings will be overwritten in the following cases:

- The project is started again
- A project is transferred

Transfer settings

A project can only be transferred from the configuration PC to the HMI device when at least one of the data channels is enabled on the HMI device.

If the HMI device is in "Transfer" mode while changes are made to the transfer settings, the settings only go into effect after the transfer function is restarted.

Requirement

You have opened the "S7-Transfer Settings" dialog box by pressing the "S7-Transfer Settings"  icon.

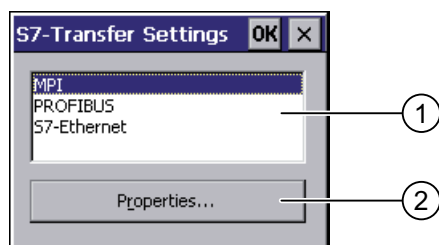

- ① Network selection
- ② Button for opening the properties dialog

Procedure

Proceed as follows:

1. Select a network.
 - If you have selected "S7 Ethernet", click the "Properties" button to open the "SMC LAN91C111 Ethernet Settings" dialog and proceed as described in the Changing the Network Configuration (Page 122) section to edit the Ethernet settings.
 - If you have selected "MPI" or "PROFIBUS", proceed with the tasks described below.
2. Open the "MPI" or "PROFIBUS" dialog with the "Properties" button:

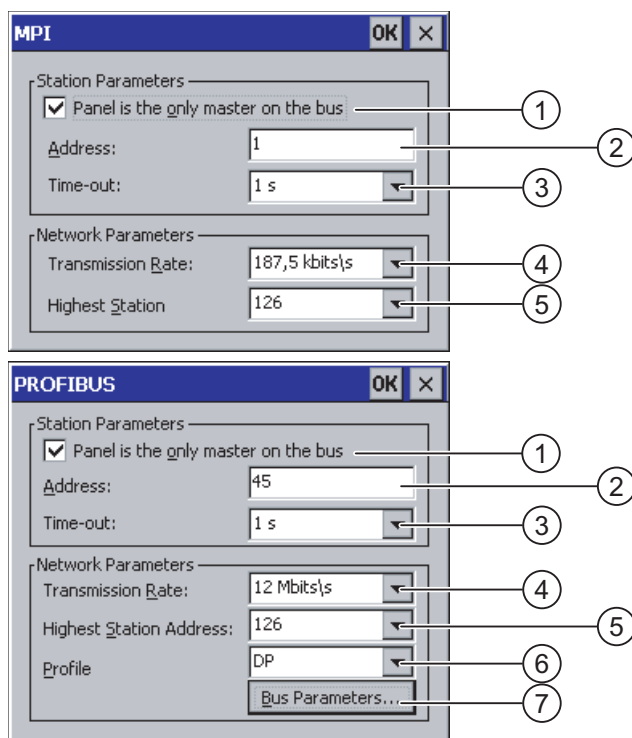

6.10 Change the communication settings

- 3. If more masters are connected to the bus, deactivate the check box "Panel is the only master on the bus".
- 4. Enter the bus address for the HMI device in the "Address" text box.

NOTICE
The bus address in the "Address" text box must be unique throughout the MPI/PROFIBUS DP network.

- 5. Select the transmission rate in the "Transmission Rate" text box.
- 6. Select the highest station address on the bus in the "Highest Station Address" or "Highest Station" text box.
- 7. Select the desired profile from the "Profile" selection box.
- 8. The profile information is displayed when you select "Bus Parameters" button in the PROFIBUS dialog. The "Profile" dialog is read-only.

NOTICE
The bus parameters must be the same for all stations in the MPI/PROFIBUS DP network.

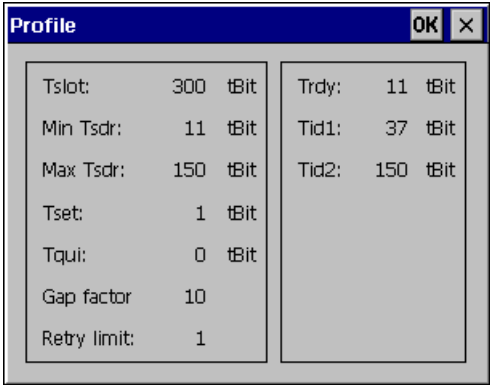

- 9. Close the "Profile" dialog.
- 10. Confirm your entries in the "MPI" or "PROFIBUS" dialog.
The dialog box closes.

Result

The MPI/PROFIBUS DP settings of the HMI device have been changed.

6.10.2 Configuring the data channel

Introduction

If you block all data channels, the HMI device is protected against unintentional overwriting of the project data and HMI device image.

Note

A project can only be transferred from the configuration PC to the HMI device when at least one of the data channels is enabled on the HMI device.

Requirement

You have opened the "Transfer Settings" dialog box by pressing the "Transfer Settings"  icon.

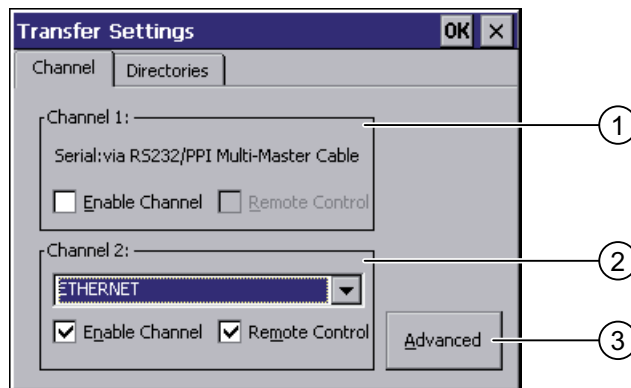

- ① Group for data channel 1 (Channel 1)
- ② Group for data channel 2 (Channel 2)
- ③ Button for the dialog "S7 Transfer Settings" or "Network and Dial-Up Connections."

Note

"Remote Control" for channel 1

Only select the "Remote Control" check box in the "Channel 1" group, if serial transfer is in progress. Clear the check box before changing to "Online" mode.

Procedure

Proceed as follows:

1. You can clear the required data channel by activating the associated "Enable Channel" check box in the "Channel 1" or "Channel 2" group.

In the "Channel 1" group, the RS-422/RS-485 port is configured for the serial data transfer.

- Select the "Enable Channel" check box to enable the data channel.
 - Clear the "Enable Channel" check box to lock the data channel.
2. Enable automatic transfer by activating the respective "Remote Control" check box in the "Channel 1" or "Channel 2" group.

| |
|--|
|  WARNING |
|--|

| |
|------------------------------------|
| Unintentional transfer mode |
|------------------------------------|

| |
|--|
| Ensure that the configuration PC does not inadvertently switch the HMI device to transfer mode while the project is in runtime. This could cause unintentional actions to be triggered in the plant. |
|--|

3. Select the required protocol for "Channel 2" in the selection box.
4. Enter further parameters if required.
 - Applies to "MPI/Profibus/S7-Ethernet:"

Press the "Advanced" button to change to the "S7-Transfer Settings" dialog. There you can change the settings for MPI/PROFIBUS or S7 Ethernet.

Confirm your entries.

The "S7-Transfer Settings" dialog box closes.
 - Applies to "ETHERNET":

Press the "Advanced" button to change to the "Network&Dial-Up Connections."

Open the "LAN9001" entry. You can change the TCP/IP settings there.

Confirm your entries.

Close "Network&Dial-Up Connections".
 - Applies to "USB:"

No further settings are required for "USB".
5. Confirm your entries.

The dialog box closes.

Result

The data channel is configured.

General information

Note

Changes during "Transfer" mode

If the HMI device is in "Transfer" mode while changes are made to the transfer settings, the settings only go into effect after the transfer function is restarted.

This may occur if the Control Panel is opened to change the transfer properties in an active project.

| |
|---|
| NOTICE |
| Serial transfer mode via channel 2 |
| The bus parameters, for example address of the HMI device, are read out of the project that is currently running on the HMI device. |
| You can change the settings for the transfer via channel 2. |
| The following steps are required: |
| <ul style="list-style-type: none">• Close the project.• Change the settings on the HMI device.• Then return to "Transfer" mode. |
| The next time the project is started on the HMI device, the settings will be overwritten by the values from the project. |

See also

Changing S7 transfer settings (Page 112)

Changing the Network Configuration (Page 122)

Operating modes (Page 138)

6.10.3 Enabling PROFINET IO

PROFINET IO

If the HMI device is connected to the PLC via PROFINET, function keys or buttons, for example, can be configured as PROFINET IO direct keys. If PROFINET IO direct keys are used in the project, they must be enabled.

Note

If you enable PROFINET IO direct keys, you cannot use the RS 422/RS 485 port for serial communication.

PROFINET IO direct keys and PROFIBUS DP direct keys are mutually exclusive.

Requirement

You have opened the "PROFINET" dialog with the "PROFINET"  icon.

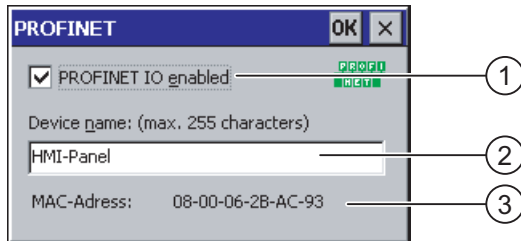

- ① Enabling or disabling the PROFINET IO direct keys
- ② Text box for the device name
- ③ MAC address of the HMI device

| |
|--|
| NOTICE |
| Inconsistent device name |
| If the device name does not match the device name entered in the HW Config of STEP 7, the direct keys do not work. |
| Use the device name from the HW Config of STEP 7. This device name does not correspond to the device name used under Windows CE. |

Within the ETHERNET data network, the device name must be unique and satisfy the DNS conventions. These include:

- Restriction to 127 characters in total (letters, digits, hyphen or point)
- A name component within the device name, e.g. a string between two points, may not exceed 63 characters.
- Special characters such as umlauts, brackets, underscores, slashes, spaces etc. are not permitted. The hyphen is the one exception.
- The device name must not start or end with a the "-" character.
- The device name must not take the form n.n.n.n (n = 0 to 999).
- The device name must not start with the character sequence "port-xyz-" (x, y, z = 0 to 9).

Procedure

1. If you want to enable the PROFINET IO direct keys, select the "PROFINET IO" check box.
2. Enter the device name of the HMI device.
3. Confirm your entries.
The dialog box closes.
4. Reboot the HMI device after saving the settings.

Result

The PROFINET IO direct keys are enabled.

See also

Restarting the HMI Device (Page 105)

6.11 Configuring network operation

6.11.1 Overview of network operation

Introduction

You can connect the HMI device to a PROFINET network via the Ethernet port.

The connection to a network offers, for example, the following options:

- Printing via a network printer
- Saving, exporting and importing of recipe data records on or from a server
- Setting up of message and data archives
- Transferring a project
- Saving data

| |
|---|
| NOTICE |
| The HMI device can only be used in PROFINET networks. |
| The HMI device only has client functionality in the PC network. This means that users can access files of a node with TCP/IP server functionality from the HMI device via the network. However, you cannot, for example, access data on the HMI device from a PC via the network. |

Note

Information on communication using SIMATIC S7 via PROFINET is provided in the "WinCC flexible communication" user manual.

Addressing

Within a PROFINET network, computers are usually addressed using computer names. These computer names are translated from a DNS or WINS server to TCP/IP addresses. This is why a DNS or WINS server is needed for addressing via computer names when the HMI device is in a PROFINET network.

The corresponding servers are generally available in PROFINET networks.

Note

The use of TCP/IP addresses to address PCs is not supported by the operating system.

Consult your network administrator if you have questions in this regard

Printing via a network printer

The HMI device's operating system does not support line by line alarm logging via a network printer. All other printing functions, for example hardcopy or logs are available without restriction via the network.

Preparation

Before beginning the configuration, request the following network parameters from your network administrator.

- Does the network use DHCP for dynamic assignment of network addresses?
If not, get a new TCP/IP network address for the HMI device.
- Which TCP/IP address does the default gateway have?
- If a DNS network is used, what are the addresses of the name server?
- If a WINS network is used, what are the addresses of the name server?

General procedure for configuring the network

The HMI device must be configured prior to network operation. The configuration is basically divided into the following steps:

Proceed as follows:

1. Enter the computer name of the HMI device.
2. Configure the network address.
3. Set the logon information.
4. Save the settings.

6.11.2 Setting the device name of the HMI device

Introduction

The HMI device uses the device name to identify itself in the network.

Requirements

You have opened the "System Properties" dialog box by pressing the "System"  icon.

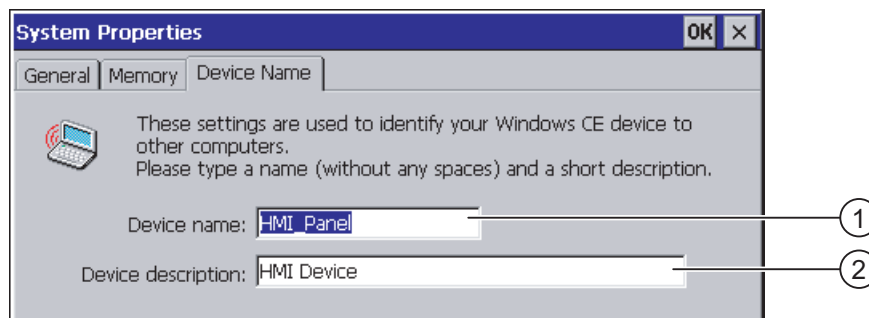

- ① Device name of the HMI device
- ② Description for the HMI device (optional)

Note

Change the device name for the HMI device in the "Device name" text box to activate the network functions.

Procedure

Proceed as follows:

1. Enter the device name for the HMI device in the "Device name" text box.
2. Enter a description for the HMI device in the "Device description" text box.
3. Confirm your entries.

The dialog closes.

Result

The device name for the HMI device is now set.

See also

Overview of network operation (Page 119)

6.11.3 Changing the Network Configuration

Overview

You can change the network settings for the LAN connection under "Network & Dial-Up Connections".

Requirement - changing LAN connection settings

You have pressed the "Network&Dial-Up Connections"  icon to open the following view.



Procedure

Proceed as follows:

1. Open the "LAN90001" entry.
 - The "'SMC LAN91C111 Ethernet' Settings" dialog opens.

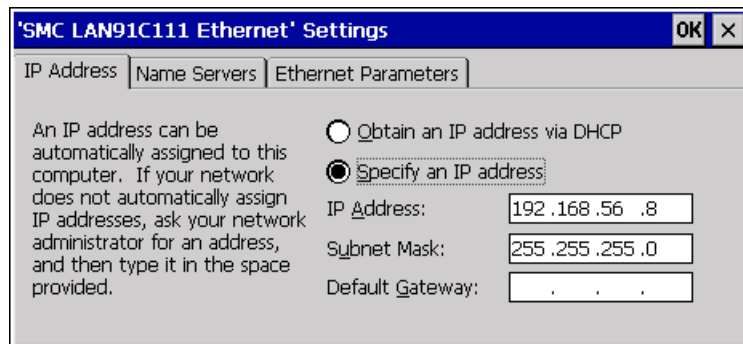

2. Select either automatic address assignment via DHCP or manual address assignment.
3. If you assign the address manually, enter the respective addresses in the text boxes for "IP Address", "Subnet Mask" and, if used, "Default Gateway".
4. If a name server is used in the network, change to the "Name Servers" tab.

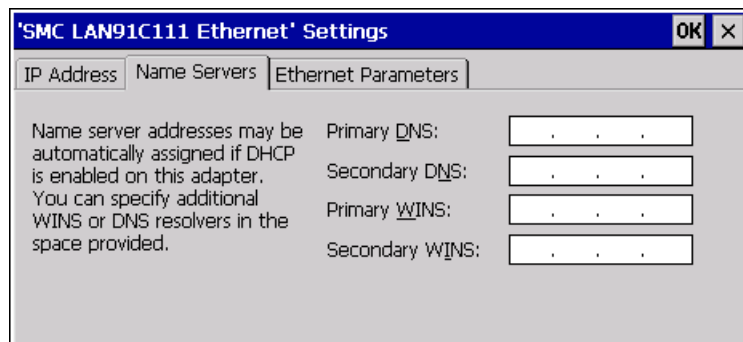

5. Enter the respective addresses in the text boxes.
6. Change to the "Ethernet Parameters" tab.

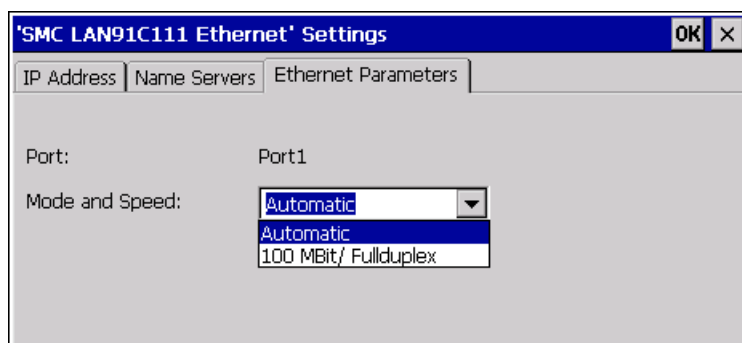

7. In the "Mode and Speed" selection list, select the transmission speed and mode.
8. Confirm your entries.
The dialog box closes.
9. Close the "Network&Dial-Up Connections" view.
The Control Panel is displayed again.

Result

The LAN connection parameters for the HMI device have been changed.

See also

Overview of network operation (Page 119)

6.11.4 Changing the Logon Data

Introduction

Windows CE uses this information to gain access to the network resources. Enter the user name, password and domain you have received from your administrator.

Requirements

You have opened the "Network ID" dialog box by pressing the "Network ID"  icon.

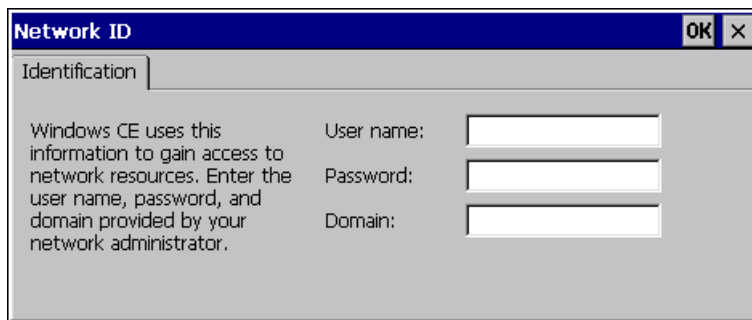

Procedure

Proceed as follows:

1. Enter the user name in the "User name" text box.
2. Enter your password in the "Password" text box.
3. Enter the domain name in the "Domain" text box.
4. Confirm your entries.

The dialog closes.

Result

The logon information has now been set.

See also

Overview of network operation (Page 119)

6.11.5 Changing E-Mail Settings

Requirement

You have opened the "WinCC flexible Internet Settings" dialog box by pressing the "WinCC Internet Settings"  icon.

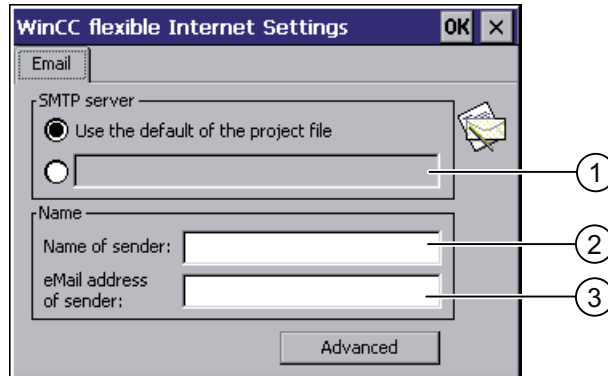

- ① Setting the SMTP server
- ② Name for the sender
- ③ E-mail account

Note

Options

The "WinCC flexible Internet Settings" tab can contain additional tabs. This depends on the options that have been enabled for network operation in the project.

Procedure – changing e-mail settings

Proceed as follows:

1. Specify the SMTP server.
 - Select the "Use the default of the project file" option button if you want to use the SMTP server configured in the project.
 - Deactivate the "Use the default of the project file" option button if you do not want to use the SMTP server configured in the project.
 - Specify the required SMTP server.
2. Enter the name for the sender in the "Name of sender" text box.
3. Enter the e-mail account for your e-mail in the "E-mail address of sender" text box.

Some e-mail providers only allow you to send mail if you specify the e-mail account. The "E-mail address of sender" text box can remain empty if your e-mail provider allows you to send mail without checking the account.

4. Confirm your entries.

The dialog box closes.

Result

The e-mail settings have been changed.

See also

Overview of network operation (Page 119)

6.11.6 Changing internet settings

6.11.6.1 Changing General Internet Settings

Requirements

You have opened the "General" tab in the "Internet Options" dialog box by pressing the "Internet Options"  icon.

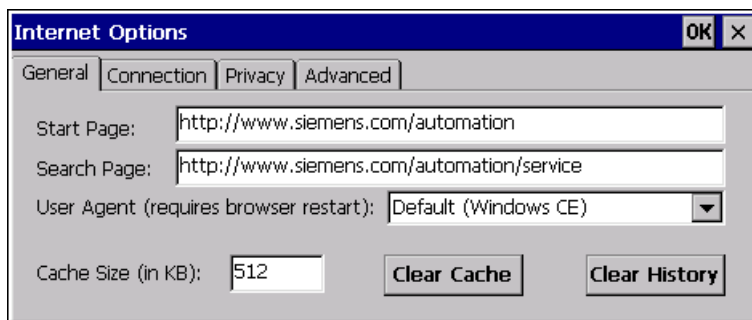

Note

Do not change the settings in the "User Agent" field.

Procedure

Proceed as follows:

1. Enter the required start page for the browser in the "Start Page" text box.
2. Enter the address of the required search engine in the "Search Page" field.
3. Enter the required cache memory size in the "Cache" text box.
4. The cache can be deleted by means of the "Clear Cache" button.
5. The history can be deleted by means of the "Clear History" button.
6. Confirm your entries.

The dialog closes.

Result

The general parameters for the Internet browser have been set.

See also

Overview of network operation (Page 119)

6.11.6.2 Setting the Proxy Server

Requirements

You have opened the "Connection" tab in the "Internet Options" dialog box by pressing the "Internet Options"  icon.



Procedure

Proceed as follows:

1. Activate the "Use LAN (no autodial)" check box.
2. If you use a proxy server, activate the "Access the Internet using a proxy server" check box in the network group.

Specify the address of the proxy server and the port.

Note

The proxy settings in the Control Panel apply to all applications that are running on the HMI device.

The Pocket Internet Explorer requires independent proxy settings that you must specify in the properties of the Pocket Internet Explorer. You can find additional information at the Microsoft's website.

3. If you want to bypass the proxy server for local addresses, activate the "Bypass proxy server for local addresses" checkbox.
4. Confirm your entries.

The dialog closes.

See also

Overview of network operation (Page 119)

6.11.6.3 Changing Privacy Settings

Cookies and encryption

Cookies are pieces of information sent by a web server to a browser. In the event of subsequent access to the web server, the cookies are sent back. This enables information to be stored between the accesses.

In order to ensure a high level of privacy, data are sent via the Internet in encrypted form. Common encryption protocols include SSL and TLS. You can activate or deactivate the usage of encryption protocols.

The required settings can be obtained from your network administrator.

Requirements

You have opened the "Privacy" tab in the "Internet Options" dialog box by pressing the "Internet Options"  icon.

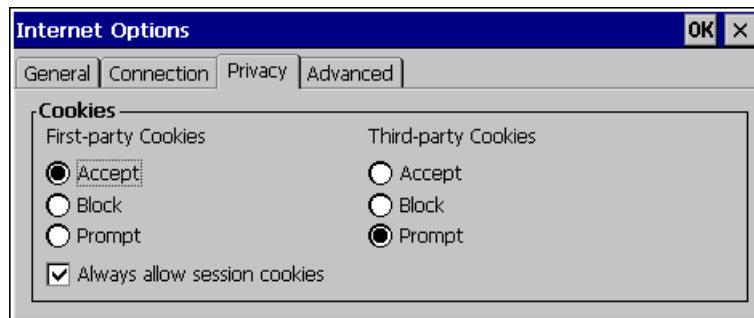

Procedure

Proceed as follows:

1. Select the required cookie behavior by means of the option buttons.
 - "Accept"
Cookies are stored without request.
 - "Block"
Cookies will not be stored.
 - "Prompt"
Cookies will be stored on request.
2. If you want allow cookies which are restricted to a single session, activate the "Always allow session cookies" checkbox.

3. Change to the "Advanced" tab.

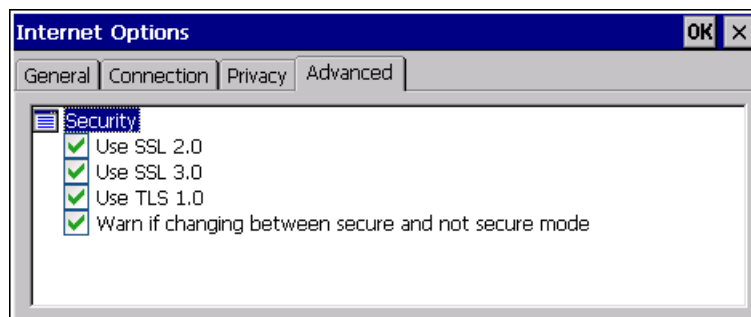

4. Activate the required encryption protocol.
5. Confirm your entries.
The dialog closes.

Result

The logon information has now been set.

See also

Overview of network operation (Page 119)

6.11.6.4 Importing and Deleting Certificates

Overview

You can import, view and delete certificates that have been imported for the HMI device. The certificates differ in the following ways:

- Certificates that you trust
- Own certificates
- Other certificates

You can import additional certificates and delete certificates that are not required.

The required settings can be obtained from your network administrator.

Requirements

You have opened the "Certificates" dialog box by pressing the "Certificates"  icon.



Procedure

Proceed as follows:

1. Select the type of certificate from the selection box:
 - "Trusted Authorities"
 - "My Certificates"
 - "Other Certificates"
2. You can start the import by pressing the "Import" button.
A dialog with source details will open.
3. If required, delete the certificate.
 - Mark the desired certificate.
 - Delete the selected certificate by pressing the "Remove" button.
4. Press the "View" button to list the properties of the selected certificate.
5. Close the dialog.

Result

The changes to the certificates have been undertaken.

See also

Overview of network operation (Page 119)

6.12 Saving to external storage device (backup)

Introduction

A backup involves copying the operating system, applications and data from the internal in flash memory of the HMI device to an external storage device.

The following external storage devices are possible:

- External memory
- USB memory stick

Requirements

- The HMI device features an external storage device with sufficient free space.
- You have opened the "Backup/Restore" dialog with the "Backup/Restore"  icon.



Procedure - using a memory card for the first time

NOTICE

Loss of data possible

The first time you use a memory card the HMI device will request that you format the card. Save a backup copy of memory card data to a PC before formatting.

Proceed as follows:

1. Cancel the formatting procedure by pressing "ESC".
2. Remove the memory card from the HMI device.
3. Save a backup copy of vital data to a PC.
4. Insert the memory card into the HMI device.
5. Format the memory card on the HMI device.

Procedure

Proceed as follows:

1. Press the "BACKUP" button to open the "Select Storage Card" dialog.

The "--- no storage card available ---" message appears if there is no external memory in the HMI device or if this memory is defective. Insert an external memory or a different one.

2. Select the external memory for backup from the "Please select a Storage Card" list box.
3. Click on the "Start Backup" button.

The HMI device checks the external memory.

If the "This storage card..." message appears, an external memory with a greater memory capacity is needed. Acknowledge this message. Backup is aborted. Insert an external memory with a greater memory capacity and restart the backup process.

If the "You may have an old backup on the storage card. Do you want to delete it?" message appears, there is already a backup on the external memory. If you do not want to overwrite the backup, press the "No" button. Otherwise click on the "Yes" button.

Several messages are displayed in sequence during the backup process:

- Saving registry data
- Copy files

A progress bar shows the status of the backup process. When the backup process is completed, the following message is displayed:

"The operation completed successfully."

4. Acknowledge this message.

The dialog closes.

Result

The HMI device data is now saved on the external memory.

6.13 Restoring from external storage device

Introduction

A restore operation deletes the old data from flash memory of the HMI device on confirmation. The data stored on the external memory is then copied to the internal flash memory.

Requirements

- The external memory holding the backed up data is inserted in the HMI device.
- You have opened the "Backup/Restore" dialog with the "Backup/Restore"  icon.



NOTICE

Loss of data possible

All data on the HMI device will be deleted during a restore operation. License keys are deleted after counter-inquiry.

Back up the HMI device's data before restoring if required.

External memory with data backup

If several external memories with data backups are plugged in, the data cannot be restored.

Remove the external memory with the data backups not needed.

Procedure

Proceed as follows:

1. Press the "RESTORE" button to open the "Storage Card" dialog.



- ① No storage card available
- ② Only one storage card containing backup is allowed. No storage card detected. Insert a storage card and press the "Refresh" button.

2. Select the external memory with the backup from the "Storage Card with Backup detected" selection box.

The "--- no storage card available ---" message appears if there is no external memory in the HMI device or if this memory is defective.

3. If the "--- no storage card available ---" message appears, press the "Cancel" button.

Restoring is then aborted.

- Insert a memory card or a different one.
- Click on the "Refresh" button.

The content of the selection box will be changed.

- Select the external memory with the backup from the "Storage Card with Backup detected" selection box.

4. Click on the "Start Restore" button.

Restoring is started.

5. The data to be restored is checked.

The following messages are displayed in sequence during the check.

- "Starting Restore"
- "Checking data"

When the data has been checked, the following message is displayed:

"You are starting RESTORE now. All files (except files on storage cards) and the registry will be erased. Are you sure?"

The message means that the restore process can be started. All files files except those located on the external memory will be deleted. Tab entries are also deleted. Are you sure?

6. If you do not want to allow the data to be deleted from the HMI device, abort the restore process by pressing the "ESC" button.

7. Start to restore the data by selecting "Yes".

The following messages are displayed in sequence during the restore:

– "Deleting files on flash"

– "Restore CE Image"

A progress bar shows the status of the restore process.

When restore is completed, the following message is displayed:

"Restore successfully finished. Press ok, remove your storage card and reboot your device."

8. Remove the external memory.

9. Acknowledge this message.

The HMI device starts.

Result

The data from the external memory is now on the HMI device.

Note

Calibrating the touch screen

After the reset, you may have to recalibrate the touch screen.

6.14 Activate Memory Management

Memory management

If reorganization of the memory is required during the runtime of project, the HMI device can shut down the project autonomously.

The project is shut down and the HMI device will display a message. You have to restart the project.

NOTICE

If you do not activate memory management, undefined states can occur during the runtime of the project.

Requirements

You have opened the "Memory Monitoring" tab in the "OP Properties" dialog box by pressing the "OP"  icon.

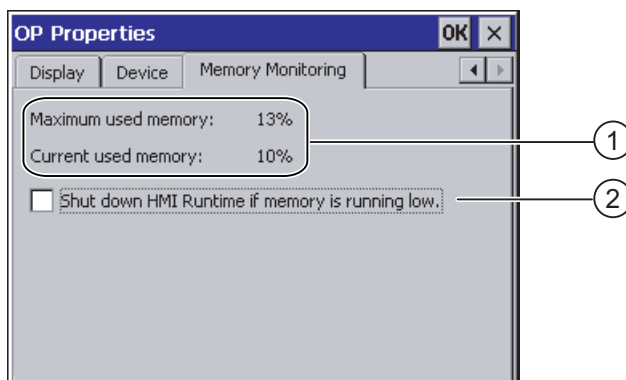

- ① The maximum used memory since last power on of the HMI device and the current used memory in percent.
- ② Control box for activation of memory management

Procedure

Proceed as follows:

1. In order to start memory management, activate the control box.
2. Confirm your entries.
The dialog closes.

Result

Memory management is activated.

Commissioning a project

7.1 Overview

Configuration phase

A project – the process image of the working process – is produced during configuration to visualize automated working processes. The process displays for the project contain displays for values and messages which provide information about process statuses. The process control phase follows the configuration phase.

Process control phase

The project must be transferred to the HMI device if it is to be used in process control. Another precondition for process control is that the HMI device is connected online to a controller. Current working processes - operating and observing - can then be subject to process control.

Transferring the project to the HMI device

You can transfer a project to an HMI device as follows:

- Transfer from the configuring PC
- Restore from a PC using ProSave

In this case, an archived project is transferred from a PC to the HMI device. The configuration software need not be installed on this PC.

Commissioning and recommissioning

Initial and re-start-ups differ in the following respects:

- When the HMI device is commissioned there is no project at first.
The HMI device is also in this state after the operating system has been updated.
- When recommissioning, any project already on the HMI device is replaced.

7.2 Operating modes

Operating modes

The HMI device may be in the following operating modes:

- Offline
- Online
- Transfer

"Offline mode" and "Online mode" can be set on both the configuring PC and the HMI device. To set these modes on the HMI device, use a corresponding operating element of the project.

Changing the operating mode

The configuration engineer must have configured an appropriate operating element to allow a change of the operating mode on the HMI device during ongoing operation.

Further information on this may be available in your plant documentation

"Offline" operating mode

In this mode, there is no communication between the HMI device and PLC. Although the HMI device can be operated, it cannot exchange data with the PLC.

"Online" operating mode

In this mode, the HMI device and PLC communicate. You can operate the plant on the HMI device according to your system configuration.

"Transfer" mode

In this mode, you can transfer a project from the configuring PC to the HMI device or backup and restore HMI device data, for example.

The following options are available for setting "Transfer" mode on the HMI device:

- When the HMI device starts up

Start "Transfer" mode manually in the HMI device Loader.

- During ongoing operation

Start the "Transfer" mode manually within the project using an operating element. The HMI device toggles to "Transfer" mode when automatic mode is set and a transfer is initiated on the configuring PC.

7.3 Using existing projects

The following table shows how you can reuse existing projects, while observing the screen size:

| HMI device in the existing project | New HMI device |
|------------------------------------|-------------------------------------|
| TP 270 10" | MP 277 10" Touch or MP 277 8" Touch |
| OP 270 10" | MP 277 10" Key |
| MP 270 6" Touch | TP 277 6" ¹⁾ |
| MP 270 10" Touch | MP 277 10" Touch or MP 277 8" Touch |
| MP 270 10" Key | MP 277 10" Key |

¹⁾ If you have set options on the MP 270 6" Touch, you must use the MP 277 8" Touch as the successor.

The following cases are possible:

1. Project in ProTool exists:

Migrate the project to WinCC flexible and subsequently carry out an HMI device switch.

2. Project in WinCC flexible exists:

Carry out an HMI device switch in WinCC flexible.

Further information on the subject can be found in the WinCC flexible Online Help or in the "WinCC flexible Migration" manual.

7.4 Data Transmission Options

Overview

The following table shows the options for data transfer between the MP 277 and the configuration PC.

| Type | Data channel | MP 277 |
|---|---|--------|
| Backup | Serial ¹⁾ | Yes |
| | MPI/PROFIBUS-DP | Yes |
| | USB | Yes |
| | Ethernet | Yes |
| Restoring | Serial ¹⁾ | Yes |
| | MPI/PROFIBUS-DP | Yes |
| | USB | Yes |
| | Ethernet | Yes |
| Update operating system. | Serial, with reset to factory state ¹⁾ | Yes |
| | Serial ¹⁾ | Yes |
| | MPI/PROFIBUS-DP | Yes |
| | USB | Yes |
| | Ethernet | Yes |
| Transferring a project | Serial ¹⁾ | Yes |
| | MPI/PROFIBUS-DP | Yes |
| | USB | Yes |
| | Ethernet | Yes |
| Installing or removing an option | Serial ¹⁾ | Yes |
| | MPI/PROFIBUS-DP | Yes |
| | USB | Yes |
| | Ethernet | Yes |
| License key transferring or transferring back | Serial ¹⁾ | Yes |
| | MPI/PROFIBUS-DP | Yes |
| | USB | Yes |
| | Ethernet | Yes |

¹⁾ Applies when PC/PPI cable is used

7.5 Transfer

7.5.1 Overview

Transfer

Transfer the executable project from the configuring PC to the HMI device.

You can start the "Transfer" mode manually or automatically on the HMI device.

Transferred data is written directly to the internal flash memory on the HMI device. For the transfer, you use a data channel which you have to configure before starting a transfer.

Backtransfer

You have the option to transfer the compressed project file together with the runtime project to the HMI device. If necessary, the compressed project file can be transferred back to the configuring PC and edited.

The HMI device must be equipped with an external memory card to which the compressed project file can be saved.

| NOTICE |
|---|
| Compressed project file WinCC flexible does not check whether the compressed project file stored on the HMI device corresponds to the existing runtime project. |

7.5.2 Starting manual transfer

Introduction

You can manually switch the HMI device to "Transfer" mode as follows:

- With a configured operating element during ongoing operation.
- In the Loader of the HMI device.

Requirements

- The project "*.hmi" is opened in WinCC flexible.
- The HMI device is connected to a configuring PC
- The data channel is configured on the HMI device
- The HMI device is in "Transfer" mode

Procedure

Proceed as follows:

1. On the configuring PC, select the "Transfer settings" command in the menu "Project > Transfer" in WinCC flexible.
The "Select devices for transfer" dialog opens.
2. Select the HMI device in the left area of the dialog.
3. Select the type of connection between the HMI device and the configuring PC.
Set the connection parameters.
4. Set the transfer parameters in the right area of the dialog.
5. If you wish to transfer the compressed project file together with the runtime project to the HMI device:
Select the "Enable backtransfer" check box.
6. Start transfer in WinCC flexible with "Transfer".
The configuring PC checks the connection to the HMI device. The project is transferred to the HMI device. If the connection is not available or is defective, an error message is displayed on the configuring PC.

Result

When the transfer is completed successfully, the project can be found on the HMI device. The transferred project is then started automatically.

See also

Operating modes (Page 138)
Configuring the data channel (Page 115)
Data Transmission Options (Page 140)

7.5.3 Starting automatic transfer

Introduction

The HMI device can be automatically switched to "Transfer" mode during runtime as soon as transfer is started on the configuring PC connected.

Automatic transfer is particularly suited for the test phase of a new project since transfer is completed without interfering with the HMI device.

Automatic transfer is available for the following data channels:

- Serial
- MPI/PROFIBUS DP
- USB
- Ethernet

NOTICE

If the automatic transfer has been activated on the HMI device and a transfer is initiated on the configuring PC, the project currently running is automatically stopped. The HMI device then automatically switches to "Transfer" mode.

After the commissioning phase, deactivate the automatic transfer so that the HMI device cannot be inadvertently switched to transfer mode. The transfer mode can trigger unintentional actions in the device.

You can set a password for the Loader of the HMI device to restrict access to the transfer settings and thus avoid unauthorized modifications.

Requirements

- The project *.hmi is opened in WinCC flexible.
- The HMI device is connected to a configuring PC
- The data channel is configured on the HMI device
- The automatic transfer is activated in the data channel for the transfer.
- The project is started on the HMI device.

Procedure

Proceed as follows:

1. On the configuring PC, select the "Transfer settings" command in the menu "Project > Transfer" in WinCC flexible.
The "Select devices for transfer" dialog opens.
2. Select the HMI device in the left area of the dialog.
3. Select the type of connection between the HMI device and the configuring PC.
Set the connection parameters.
4. Set the transfer parameters in the right area of the dialog.
5. If you wish to transfer the compressed project file together with the runtime project to the HMI device:
Select the "Enable backtransfer" check box.
6. Start transfer in WinCC flexible with "Transfer".

The configuring PC checks the connection to the HMI device. The HMI device shuts down the current project and automatically switches to "Transfer" mode. The project is transferred to the HMI device. If the connection is not available or is defective, an error message is displayed on the configuring PC.

Result

When the transfer is completed successfully, the project can be found on the HMI device. The transferred project is then started automatically.

See also

Operating modes (Page 138)

Configuring the data channel (Page 115)

Data Transmission Options (Page 140)

7.5.4 Starting backtransfer

Requirements

- No project is open on the configuring PC in WinCC flexible
- The HMI device is connected to this configuring PC
- The data channel is configured on the HMI device
- The HMI device is in "Transfer" mode
- The memory card containing the compressed project file is inserted into the HMI device

Procedure

Proceed as follows:

1. On the configuring PC, select the "Communication settings" command in the menu "Project > Transfer" in WinCC flexible.

The "Communication Settings" dialog opens.

2. Select the type of HMI device.
3. Select the type of connection between the HMI device and the configuring PC.

Set the connection parameters.

4. Close the dialog with "OK".
5. Select the "Transfer" > "Backtransfer" command in the "Project" menu.

The "Backtransfer" dialog opens.

6. Click "OK" to start the backtransfer process.

The configuring PC checks the connection to the HMI device. The compressed project file is transferred back from the HMI device to the configuring PC. If the connection is not available or is defective, an error message is displayed on the configuring PC.

Result

After successful backtransfer, the project is opened on the configuring PC in WinCC flexible.

7.5.5 Testing a project

Introduction

There are two options to test a project:

- Test the project on the configuring PC

You can test a project at a configuring PC, using a simulator. For detailed information, refer to the "WinCC flexible" user manual and to the WinCC flexible Online Help.

- Offline testing of the project on the HMI device

Offline testing means that communication between the HMI device and PLC is down while the test is being carried out.

- Online testing of the project on the HMI device

Online testing means that the HMI device and PLC communicate with each other during testing.

Perform the tests, starting with the "Offline test", followed by the "Online test".

Note

You should always test the project on the HMI device on which the project will be used.

Check the following:

1. Check the correct layout of the screens
2. Check the screen navigation
3. Check the input objects
4. Enter the tag values

The test increases the certainty that the project will run error-free on the HMI device.

Requirements for offline testing

- The project has been transferred to the HMI device
- The HMI device is in "Offline" mode

Procedure

In "Offline" mode, you can test individual project functions on the HMI device without them being affected by the PLC. PLC tags, therefore, are not updated.

Test the operating elements and visualization of the project as far as possible without connecting to the PLC.

Requirements for online testing

- The project has been transferred to the HMI device
- The HMI device is in "Online" mode

Procedure

In "Online" mode, you can test individual project functions on the HMI device without them being affected by the PLC. PLC tags are updated in this case.

You have the option to test all communication-dependent functions, for example alarms, etc.

Test the operating elements and views of the project.

7.6 Backup and restore

7.6.1 Overview

Backup and restore

| |
|--|
| NOTICE |
| License keys License keys are not taken into account for backups and restores. License keys are saved in the working memory of the HMI device and cannot be deleted. |

You can back up and restore the following data found in the internal flash memory of the HMI device with a PC:

- Project and HMI device image
- Password list
- Recipe data

Use one of the following tools for backup and restore:

- WinCC flexible
- ProSave

General information

| |
|--|
| NOTICE |
| Power failure If a complete restore operation is interrupted due to power failure on the HMI device, the operating system of the HMI device may be deleted! The operating system then has to be updated. |
| Compatibility conflict If a message is output on the HMI device warning of a compatibility conflict during the restore operation, the operating system must be updated. |

7.6.2 Backup and restore using WinCC flexible

Requirements

- The HMI device is connected to a configuring PC
- No project is open in WinCC flexible
- The data channel is configured on the HMI device

Procedure for backup

Proceed as follows:

1. On the configuring PC, select the "Communication settings" command in the menu "Project > Transfer" in WinCC flexible.
The "Communication Settings" dialog opens.
2. Select the type of HMI device.
3. Select the type of connection between the HMI device and the configuring PC.
Set the connection parameters.
4. Close the dialog with "OK".
5. Select the "Backup" command in the menu "Project > Transfer" in WinCC flexible.
The "Backup Settings" dialog opens.
6. Select the data to be backed up.
7. Select a destination folder and a file name for the "*.psb" backup file.
8. Set "Transfer" mode on the HMI device.
If automatic transfer mode is enabled on the HMI device, the HMI device automatically sets "Transfer" mode when a backup is initiated.
9. Start the backup operation in WinCC flexible with "OK" on the configuring PC.
Follow the instructions in WinCC flexible.
A status view opens to indicate the progress of the operation.

Result

The system outputs a message when the backup is completed.
The relevant data is now backed up on the configuring PC.

Procedure for restore

Proceed as follows:

1. On the configuring PC, select the "Communication settings" command in the menu "Project > Transfer" in WinCC flexible.
The "Communication Settings" dialog opens.
2. Select the type of HMI device.
3. Select the type of connection between the HMI device and the configuring PC.
Set the connection parameters.
4. Close the dialog with "OK".
5. Select the "Restore" command in the menu "Project > Transfer" in WinCC flexible.
The "Restore Settings" dialog opens.
6. Select the "*.psb" backup file to be restored from the "Open" field.
You can see the HMI device for which the backup file was created and the type of backup data the file contains.
7. Set "Transfer" mode on the HMI device.
If automatic transfer mode is enabled on the HMI device, the device automatically sets "Transfer" mode when a restore operation is initiated.
8. Start the restore operation in WinCC flexible with "OK" on the configuring PC.
Follow the instructions in WinCC flexible.
A status view opens to indicate the progress of the operation.

Result

When the restore is successfully completed, the data backed up on the configuring PC is now on the HMI device.

See also

- Overview (Page 146)
- Data Transmission Options (Page 140)
- Operating modes (Page 138)
- Configuring the data channel (Page 115)

7.6.3 Backup and restore using ProSave

Requirements

- The HMI device is connected to a PC on which ProSave is installed
- The data channel is configured on the HMI device

Procedure for backup

Proceed as follows:

1. From the Windows Start menu, start ProSave on the PC.
2. Select the HMI device type in the "General" tab.
3. Select the type of connection between the HMI device and the PC.
Set the connection parameters.
4. Select the data to be backed up in the "Backup" tab.
5. Select a destination folder and a file name for the "*.psb" backup file.
6. Set "Transfer" mode on the HMI device.

If automatic transfer mode is enabled on the HMI device, the HMI device automatically sets "Transfer" mode when a backup is initiated.

7. Start the backup operation in ProSave with "Start Backup".
Follow the instructions in ProSave.
A status view opens to indicate the progress of the operation.

Result

The system outputs a message when the backup is completed.
The relevant data is now backed up on the PC.

Procedure for restore

Proceed as follows:

1. From the Windows Start menu, start ProSave on the PC.
2. Select the HMI device type in the "General" tab.
3. Select the type of connection between the HMI device and the PC.

Set the connection parameters.

4. Select the "*.psb" backup file to be restored from the "Restore" tab.

You can see the HMI device for which the backup file was created and the type of backup data the file contains.

5. Set "Transfer" mode on the HMI device.

If automatic transfer mode is enabled on the HMI device, the device automatically sets "Transfer" mode when a restore operation is initiated.

6. Start the restore operation in ProSave on the PC with "Start Restore".

Follow the instructions in ProSave.

A status view opens to indicate the progress of the operation.

Result

When the restore is successfully completed, the data backed up on the PC is now on the HMI device.

See also

Overview (Page 146)

Data Transmission Options (Page 140)

Operating modes (Page 138)

Configuring the data channel (Page 115)

7.7 Updating the operating system

7.7.1 Overview

Updating the operating system

A compatibility conflict may occur when transferring a project to the HMI device. This is caused by different versions of the configuration software used and the HMI device image available on the HMI device. If there are different versions, the transfer is aborted. A message indicating a compatibility conflict is displayed on the configuration PC.

There are two ways to match the versions:

- Update the HMI device image if the project was created with the most recent version of the configuration software.
- Transfer a matching version of the HMI device image if you do not want to adapt the project for the HMI device to the most recent version of the configuration software for the project.

| |
|---|
| NOTICE |
| Data loss |
| All data on the HMI device, such as the project and licenses, will be deleted when you update the operating system. |

Note

When WinAC MP is used, all data channel parameters are reset.

Note**Calibrating the touch screen**

After the update, you may have to recalibrate the touch screen.

7.7.2 Resetting factory settings

In ProSave or WinCC flexible, you can update the operating system with or without resetting to factory settings.

- Updating the operating system without resetting to factory settings

First, switch into "Transfer" mode on the HMI device or use the automatic transfer function if the project is active. Then start the operating system update in ProSave or WinCC flexible.

- Updating the operating system with resetting to factory settings

| |
|---|
| NOTICE |
| Loss of license keys The license keys on the HMI device will be deleted when resetting to factory settings. The license keys on the HMI device will be retained when updating the operating system without resetting to factory settings. |

| |
|---|
| NOTICE |
| Data channels When resetting to factory settings, all data channel parameters are reset. The transfer can only be started following reconfiguration of the data channels. |

Note

You have to perform an operating system update with reset to factory settings if the HMI device does not yet have an operating system or if the HMI device's operating system is corrupt.

First, start the operating system update in ProSave or WinCC flexible and switch the power on the HMI device off and on again when prompted.

7.7.3 Updating the Operating System using WinCC flexible

Requirement

- No project is open on the configuration PC in WinCC flexible.
- The HMI device is connected to this configuration PC.
- When updating the operating system without reset to factory state: The data channel on the HMI device is configured.

Procedure

Proceed as follows:

1. When updating the operating system with reset to factory state only:
Switch off power to the HMI device.
2. On the configuration PC, select the "Communication settings" command in the menu "Project > Transfer" in WinCC flexible.
The "Communication Settings" dialog opens.
3. Select the type of HMI device.
4. Select the type of connection between the HMI device and the configuration PC, then set the connection parameters.
5. Close the dialog box with "OK".
6. Select the "OS Update" command from the "Project > Transfer" menu in WinCC flexible.
7. Select whether to update the operating system with or without restoring the factory state by setting the "Reset to factory settings" check box accordingly.
8. Select the HMI device image file "*.img" under "Image path".
The HMI device image files are available under "WinCC flexible Images" in the WinCC flexible installation folder or on the WinCC flexible installation CD.
The output area provides information on the version of the successfully opened HMI device image file.
9. When updating without reset to the factory state only:
Set "Transfer" mode on the HMI device.
If automatic transfer mode is enabled on the HMI device, the device automatically sets "Transfer" mode when an update is initiated.
10. In WinCC flexible, select "Update OS" on the configuration PC to run the operating system update.
11. When updating with reset to the factory state only:
Switch on the power supply to the HMI device.
12. Follow the instructions in WinCC flexible.
A progress bar indicates the progress of the operating system update.

Result

A message is displayed when the operating system update is successfully completed.
The HMI device no longer contains any project data.

See also

Overview (Page 155)
Configuring the data channel (Page 115)
Operating modes (Page 138)
Data Transmission Options (Page 140)

7.7.4 Updating the Operating System using ProSave

Requirement

- The HMI device is connected to a PC on which ProSave is installed.
- When updating the operating system without reset to factory state only:
The data channel is configured on the HMI device.

Procedure

Proceed as follows:

1. When updating the operating system with reset to factory state only:
Switch off power to the HMI device.
2. Go to the Windows Start menu and start ProSave on the PC.
3. Select the HMI device type in the "General" tab.
4. Select the type of connection between the HMI device and the PC, then set the connection parameters.
5. Select the "OS Update" tab.
6. Select whether to update the operating system with or without restoring the factory state by setting the "Reset to factory settings" check box accordingly.
7. Select the HMI device image file "*.img" under "Image path".
The HMI device image files are available under "WinCC flexible Images" in the WinCC flexible installation folder or on the WinCC flexible installation CD.
The output area provides information on the version of the successfully opened HMI device image file.
8. When updating without reset to the factory state only:
Set "Transfer" mode on the HMI device.
If automatic transfer mode is enabled on the HMI device, the device automatically sets "Transfer" mode when an update is initiated.
9. Select "Update OS" on the PC to run the operating system update.
10. When updating with reset to the factory state only:
Switch on the power supply to the HMI device.
11. Follow the instructions in ProSave.
A progress bar indicates the progress of the operating system update.

Result

A message is displayed when the operating system update is successfully completed.
The HMI device no longer contains any project data.

See also

- Overview (Page 155)
- Configuring the data channel (Page 115)
- Operating modes (Page 138)
- Data Transmission Options (Page 140)

7.8 Installing and removing options

7.8.1 Overview

Installing and removing options

You can install options on the HMI device, for example, additional programs developed especially for the HMI device.

You can also remove the option from the HMI device again.

Note

License key

A license key may be needed to run an option. The license key unlocks the option for use.

7.8.2 Installing and removing options using WinCC flexible

Requirements

- The HMI device is connected to a configuring PC
- No project is open in WinCC flexible
- The data channel is configured on the HMI device

Procedure for installing an option

Proceed as follows:

1. On the configuring PC, select the "Communication settings" command in the menu "Project > Transfer" in WinCC flexible.
The "Communication Settings" dialog opens.
2. Select the type of HMI device.
3. Select the type of connection between the HMI device and the configuring PC, then set the connection parameters.
4. Close the dialog with "OK".
5. Select the "Options" command in the menu "Project > Transfer" in WinCC flexible.

6. Select the desired option under "Available options".
7. Set "Transfer" mode on the HMI device.
If automatic transfer mode is enabled on the HMI device, the device automatically sets "Transfer" mode when the installation of an option is initiated.
8. Start the installation of the option in WinCC flexible on the configuring PC with the ">>" button.
Follow the instructions in WinCC flexible.
A status display appears indicating the progress of the installation.

Result

The option has now been installed on the HMI device.

Procedure for removing an option

Proceed as follows:

1. On the configuring PC, select the "Communication settings" command in the menu "Project > Transfer" in WinCC flexible.
The "Communication Settings" dialog opens.
2. Select the type of HMI device.
3. Select the type of connection between the HMI device and the configuring PC, then set the connection parameters.
4. Close the dialog with "OK".
5. Select the "Options" command in the menu "Project > Transfer" in WinCC flexible.
6. Select the desired option under "Installed options".
7. Set "Transfer" mode on the HMI device.
If automatic transfer mode is enabled on the HMI device, the device automatically sets "Transfer" mode when the removal of an option is initiated.
8. Start the removal of the option in WinCC flexible on the configuring PC with the "<<" button.
Follow the instructions in WinCC flexible.
A status display appears indicating the progress of the removal.

Result

The option has now been removed on the HMI device.

See also

- Operating modes (Page 138)
- Overview (Page 155)
- Configuring the data channel (Page 115)
- Data Transmission Options (Page 140)

7.8.3 Installing and removing options using ProSave

Requirements

- The HMI device is connected to a PC on which ProSave is installed
- The data channel is configured on the HMI device

Procedure for installing an option

Proceed as follows:

1. From the Windows Start menu, start ProSave on the PC.
2. Select the HMI device type in the "General" tab.
3. Select the type of connection between the HMI device and the PC.
4. Set the connection parameters.
5. Select the "Options" tab.
6. Select the desired option under "Available options".
7. Set "Transfer" mode on the HMI device.

If automatic transfer mode is enabled on the HMI device, the device automatically sets "Transfer" mode when the installation of an option is initiated.

8. Start the installation of the option in ProSave with the ">>" button.
9. Follow the instructions in ProSave.

A status display appears indicating the progress of the installation.

Result

The option has now been installed on the HMI device.

Procedure for removing an option

Proceed as follows:

1. From the Windows Start menu, start ProSave on the PC.
2. Select the HMI device type in the "General" tab.
3. Select the type of connection between the HMI device and the PC.
4. Set the connection parameters.
5. Select the "Options" tab.
6. Press the "Device status" button to update the display.
7. Select the desired option under "Installed options".
8. Set "Transfer" mode on the HMI device.

If automatic transfer mode is enabled on the HMI device, the device automatically sets "Transfer" mode when the removal of an option is initiated.

9. Start the removal of the option in ProSave with the "<<" button.

Follow the instructions in ProSave.

A status display appears indicating the progress of the removal.

Result

The option has now been removed on the HMI device.

See also

Overview (Page 155)

Configuring the data channel (Page 115)

Operating modes (Page 138)

Data Transmission Options (Page 140)

7.9 Transferring and transferring back license keys

7.9.1 Overview

With the purchase of an add-on package, you obtain a specific user license with an associated license key. Once you have installed an add-on, transfer a license key to the HMI device. The license key unlocks an add-on for use.

You can also transfer back the license key from the HMI device to a license diskette.

Note

License keys can only be transferred and transferred back with the Automation License Manager or WinCC flexible.

7.9.2 Transferring and transferring back license keys

Requirements

- The HMI device is connected to a configuring PC
- When transferring or transferring back using WinCC flexible:
No project is open in WinCC flexible
- The data channel is configured on the HMI device
- The license diskette with the license key to be transferred must be inserted in the floppy drive of the configuring PC

Procedure for transferring a license key

Proceed as follows:

1. Switch to "Transfer" mode on the HMI device.
2. When transferring using WinCC flexible:
Select the "License Keys" command in the menu "Project > Transfer". The Automation License Manager opens.
When transferring using the Automation License Manager:
Start the Automation License Manager via the Windows Start menu.
3. In the Automation License Manager, select the command "Connect HMI device" in the menu "Edit > Connect target system".
The "Connect Target System" dialog opens.
4. Under "Device Type", select the appropriate HMI device type.
5. Select the type of connection in the "Connection" field and set the connection parameters.
6. Select "OK".
The connection to the HMI device is established. The connected HMI device is displayed in the left window of the Automation License Manager.
7. In the left window, select the source drive.
The right window displays the available license keys.
8. Drag one or more license keys from the right window and drop them on the HMI device in the left window.
The license keys are then transferred to the HMI device.

Result

The license key has now been transferred from the license diskette to the HMI device.

Procedure for transferring a license key back

Proceed as follows:

1. Switch to "Transfer" mode on the HMI device.
2. When transferring back using WinCC flexible:
Select the "License Keys" command in the menu "Project > Transfer". The Automation License Manager opens.
When transferring back using the Automation License Manager:
Start the Automation License Manager via the Windows Start menu.
3. In the Automation License Manager, select the command "Connect HMI device" in the menu "Edit > Connect target system".
The "Connect Target System" dialog opens.
4. Under "Device Type", select the appropriate HMI device type.
5. Select the type of connection in the "Connection" field and set the connection parameters.
6. Select "OK".
The connection to the HMI device is established. The connected HMI device is displayed in the left window of the Automation License Manager.
7. In the left window, select the HMI device.
The right window displays the available license keys.
8. Drag one or more license keys from the right window and drop them on the HMI device in the left window.
The license keys are then transferred back to the license diskette.

Result

The license key has now been transferred back from the HMI device to the license diskette.

See also

- Overview (Page 155)
- Configuring the data channel (Page 115)
- Operating modes (Page 138)
- Data Transmission Options (Page 140)

Operating a project

8.1 Overview

Configuration and process control phase

HMI devices can be used to operate and monitor tasks in process and production automation. The plant screens on the HMI devices are used to provide a clear overview of the active processes.

The HMI device project, which includes the plant screens, is created during the configuration phase. The configuration engineer defines which tasks the HMI device has in the process and defines the following in detail:

- Which process data is displayed on the individual HMI device
- Which plant components are controlled by this HMI device

The configuration engineer stores this information in the project's screens. The project is transferred to the HMI device during commissioning.

After transfer to the HMI device, current processes can be operated and monitored in the project's screens. The screens enable you to observe, for example, operational states, current process data and faults in a plant. Operating elements which are used to operate the process, for example buttons, I/O fields and alarm windows, are displayed in the screens.

Operator control options

The hardware of the HMI device determines which of the following operator control options are available:

- Touch screen

The operating elements shown in the dialogs are touch-sensitive. Touch objects are basically operated in the same way as mechanical keys. You activate operating elements by touching them with your finger. To double-click them, touch an operating element twice in succession.

- HMI device keyboard

The operating elements shown in the screens are selected and operated using the keys of the HMI device.

- External keyboard, connected via USB
- External mouse, connected via USB

CAUTION

Do not use any pointed or sharp objects when operating the touch screen. Otherwise this may damage the plastic membrane of the touch screen.

The following provides instructions for operating a project with the touch screen and the keyboard.

Operating a project with an external keyboard

An external keyboard can be used to operate a project in exactly the same way as with the HMI keyboard or screen keyboard.

Note

The function keys of the external keyboard are disabled.

Use the other keys of the external keyboard, which correspond to the HMI device keys in the description.

Operating a project with an external mouse

An external mouse can be used to operate a project in exactly the same way as with the HMI touch screen. Click the described operating elements with the mouse.

Unintentional actions

| |
|--|
|  CAUTION |
| Do not carry out several operations simultaneously. You may otherwise trigger unintentional actions. |
| <ul style="list-style-type: none">• With touch control: Always touch only one operating element on the screen• With key control: Do not press more than two keys simultaneously |

Observing the plant documentation

Some operations with the project may require in-depth knowledge about the specific plant on the part of the operator. Proceed with caution, for example, when you use jog mode. Further information on this may be available in your plant documentation

Operation feedback from operating elements

The HMI device provides operation feedback as soon as it detects that an operating element has been selected. This operation feedback is independent of any communication with the PLC. Therefore, this operation feedback does not indicate whether the relevant action is actually executed or not.

Optical feedback from operating elements

The operating element receives the focus and is selected. The configuration engineer can also configure the selection of an operating element so that it deviates from the standard. Further information on this may be available in your plant documentation

The type of optical feedback depends on the operating element:

- Buttons

The HMI device outputs different views of the "Pressed" and "Unpressed" states, provided the configuration engineer has configured a 3D effect:

- "Pressed" state:



- "Unpressed" state:



The configuration engineer determines the appearance of a selected field, for example, line width and color for the focus.

- Invisible buttons

By default, invisible buttons are not displayed as pressed when they are touched. No optical feedback is provided in this case.

The configuration engineer may, however, configure invisible buttons so that their outline appears as lines when touched. This outline remains visible until you select another operating element.

- I/O fields

When you select an I/O field, the content of the I/O field is displayed against a colored background. With touch operation, a screen keyboard is displayed for the entering of values.

Acoustic feedback from operating elements

As soon as the HMI device detects a touch of the touch screen or that a key has been pressed, an acoustic signal is issued. You can activate or deactivate this acoustic operation feedback.

Note

The acoustic feedback is only possible if you interact with the project directly on the touch screen or press one of the keys of the HMI device. If you use an external mouse or keyboard for interaction, no acoustic signal is issued.

Acoustic signal for inadvertent operations

If you try to enter an invalid character, the HMI device issues an acoustic signal in accordance with the setting.

See also

Set the volume (Page 103)

8.2 Direct keys

Introduction

Direct keys on the HMI device are used to set bits in the I/O area of a SIMATIC S7.

Direct keys enable operations with short reaction times that are, for example, a jog mode requirement.

| |
|---------------|
| NOTICE |
|---------------|

| |
|--|
| Direct keys are still active when the HMI device is in "offline" mode. |
|--|

| |
|---------------|
| NOTICE |
|---------------|

| |
|---|
| If you operate a function key with direct key functionality in a running project, the direct key function is always executed, independent of the current screen contents. |
|---|

Note

You can only use direct keys when there is a connection via PROFIBUS DP or PROFINET IO.

Direct keys result in additional basic load on the HMI device.

Direct keys

The following objects can be configured as a direct key:

- Buttons
- Function keys

You can also define image numbers in the case of HMI devices with touch operation. In this way, the project engineer can configure the direct keys on an image-specific basis.

Further information on configuring direct keys can be found in the "WinCC flexible Communication" system manual.

See also

Bit assignment of the direct keys (Page 258)

Enabling PROFINET IO (Page 117)

8.3 Setting the project language

Introduction

The HMI device supports multilingual projects. You must have configured a corresponding operating element which lets you change the language setting on the HMI device during runtime.

The project always starts with the language set in the previous session.

Requirements

- The required language for the project must be available on the HMI device
- The language switching function must be logically linked to a configured operating element such as a button

Selecting a language

You can change project languages at any time. Language-specific objects are immediately output to the screen in the new language when you switch languages.

The following options are available for switching the language:

- A configured operating element switches from one language to the next in a list
- A configured operating element directly sets the desired language

Please refer to your system documentation to check whether additional information on this subject is available there.

See also

Changing Regional Settings (Page 97)

8.4 Entering values using the touch screen

8.4.1 Overview

Screen keyboard

When you touch an operating element requiring entry on the HMI device touch screen, a screen keyboard appears. The screen keyboard is displayed in the following cases:

- An I/O field is selected for input
- A password must be entered for accessing a password-protected function

The screen keyboard is automatically hidden again when input is complete.

Based on the configuration of the operating element, the system displays different screen keyboards for entering numerical or alphanumerical values.

Note

The screen keyboard display is independent of the configured project language.

General procedure

The operating elements of a screen are operated by touching the touch screen.

Proceed as follows:

1. Touch the desired operating element within the screen.
2. Depending on the operating element, perform further actions. Detailed descriptions can be found under the respective operating element.

Examples:

- I/O field: Enter numerical, alphanumerical or symbolic values in the I/O field
- Symbolic I/O field: Select an entry from the drop down list box
- Slider control: Move the slider control

Procedure for text boxes

Values are entered in the project text boxes. Based on your configuration, the values are saved to tags and transferred, for example, to the PLC.

Proceed as follows:



1. Touch the desired text box within the screen.

The screen keyboard opens.

Depending on your configuration, you can enter values in the text box in the following manner:

- Numerical values, for example decimal numbers, hexadecimal numbers, binary values
- Alphanumerical values, for example digits and letters
- Date/time

2. Enter the value.

3. Confirm your entry with  or discard your entry with the button .

8.4.2 Entering and Editing Numerical Values

Numerical screen keyboard

When you touch an operator control for numerical input on the HMI-device touch screen, the numerical screen keyboard appears. This is the case, for example, for a text box. The screen keyboard is automatically hidden again when input is complete.



Note

Opened screen keyboard

When the screen keyboard is open, PLC job 51, "Select screen" has no function.

Formats for numerical values

You can enter values in numerical text boxes based on the following formats:

- Decimal
- Binary
- Hexadecimal

Note

Entry of hexadecimal values

When you enter values in hexadecimal format, the alphanumerical screen keyboard opens.

Limit test of numerical values

Tags can be assigned limits. If you enter a value that lies outside of this limit, it will not be accepted, for example, 80 with a limit of 78. In this case the HMI device will deliver a system alarm, if an alarm window is configured. The original value is displayed again.

Decimal places for numerical values

The configuration engineer can define the number of decimal places for a numerical text box. The number of decimal places is checked when you enter a value in this type of I/O field.

- Decimal places in excess of the limit are ignored.
- Empty decimal places are filled with "0".

Procedure

Numerical values can be entered character-by-character via the buttons on the numerical screen keyboard.

Proceed as follows:

1. Touch the desired operator control within the screen.



The numerical screen keyboard opens. The existing value is displayed in the screen keyboard and is selected.

2. Enter the value.

The keys with for example the letters G to Z are available to enter a hexadecimal value; however, the characters are not entered. Depending on the settings, the HMI device outputs an audible signal.

You have the following options to enter a value:

- The selected value is deleted when you enter the first character. Completely reenter the value.



- Use the  and  keys to move the cursor within the current value. You can now edit the characters of the current value or add characters.

Use the  key to delete the character to the left of the cursor. If the value is selected, use this key to delete the selected part of the value.

The  key deletes the character positioned to the right of the cursor. If the value is selected, use this key to delete the selected part of the value.

- Use the  key to display the info text of the I/O field.

This key is only enabled if info text has been configured for the input object or the current screen.

3. Use the  key to confirm your entry or cancel it with . Either action closes the screen keyboard.

Result

You have changed the numerical value or entered a new one.

8.4.3 Entering and editing alphanumerical values

Alphanumerical screen keyboard

When you touch an operator control for alphanumerical input on the HMI-device touch screen, the alphanumerical screen keyboard appears. This is the case, for example, for a text box. The screen keyboard is automatically hidden again when input is complete.



Note

Opened screen keyboard

When the screen keyboard is open, PLC job 51, "Select screen" has no function.

Language switching

Language switching in the project has no influence on the alphanumerical screen keyboard. The entry of Cyrillic or Asian characters is therefore not possible.

Keyboard levels

The alphanumerical screen keyboard has various levels.

- Normal level
- Shift level

If you change the levels with key , the key assignments change.

Procedure

Alphanumerical values can be entered character-by-character via the buttons on the alphanumerical screen keyboard.

Proceed as follows:



1. Touch the desired operator control within the screen.

The alphanumerical screen keyboard opens. The existing value is displayed in the screen keyboard and is selected.

2. Enter the value.

You have the following options to enter a value:

- The selected value is deleted when you enter the first character. Completely reenter the value.

- Use the  and  keys to move the cursor within the current value. You can now edit the characters of the current value or add characters.



Use the  key to delete the character to the left of the cursor. If the value is selected, use this key to delete the selected part of the value.

The  key deletes the character positioned to the right of the cursor. If the value is selected, use this key to delete the selected part of the value.

- Using key  it is possible to switch between the keyboard levels of the screen keyboard. On switchover, the key assignments of the screen keyboard change.

- Use the  key to display the info text of the I/O field.

This key is only enabled if info text has been configured for the input object or the current screen.

3. Use the  key to confirm your entry or cancel it with . Either action closes the screen keyboard.

Result

You have changed the alphanumeric value or entered a new one.

8.4.4 Entering the date and time

Entering the date and time

Enter the date and time in the same way you enter alphanumerical values.

Note

When entering the date and time, please note that the format is determined by the configured project language.

See also

Entering and Editing Numerical Values (Page 167)

Entering and editing alphanumerical values (Page 170)

8.4.5 Entering Symbolic Values

Selection list

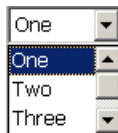

Operator control for entering symbolic values offer you a list from which you can select the input values. When you touch a symbolic I/O field on the HMI device touch screen, the following selection list opens.



Procedure

Proceed as follows:

1. Touch the required operator control.

The selection list of the operator control opens. Select  and  to scroll in the selection list.

2. Touch the required entry in the selection list.

The selected entry is accepted as an entry.

Result

You have changed the symbolic value or entered a new one.

8.4.6 Displaying Infotext

Purpose

The configuration engineer uses info text to provide additional information and operating instructions. The configuration engineer can configure info text on screens and operator controls.

The infotext of an I/O field can contain, for example, information on the value to be entered.

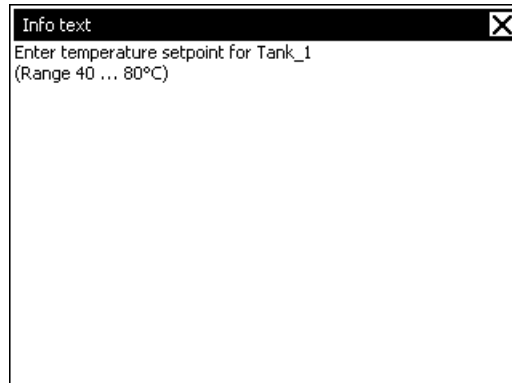

Opening info text for operator controls

1. Touch the required operator control.

The screen keyboard opens. You can see from the appearance of the  key whether info text has been configured for the operator control or the current screen.

2. Touch the  key on the screen keyboard.

The info text for the operator control is displayed. If there is no info text for the selected screen object, the info text for the current screen is displayed, if it has been configured.

You can scroll through the contents of long info text with  and .

Note

Switching between displayed info text

The configuration engineer can configure infotext for an I/O field and the associated screen. You can switch between two info texts by touching the info text window.

3. Close the displayed info text by pressing .

Alternative procedure

Depending on your configuration, info text can also be called via a configured operator control.

Refer to your plant documentation to find any available additional information on this topic.





8.5 Entering values using the keys

8.5.1 Control keys



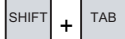





Introduction







The following tables show the control keys with which you operate the project. You will also find detailed descriptions under the individual operating elements.

Select operating elements





| Key | Functions | Description |
|--|-------------|---|
|   | Tabulator | Selects the next/previous operating element in the tab sequence. |
|     | Cursor keys | Selects the next operating element to the left, right, above or below the current screen object. Navigates in the operating element. |

Using operating elements

| Key | Functions | Description |
|--|-------------------------|---|
|     | Position the cursor | Positions the cursor within an operating element, e.g. in the I/O field. |
|  | Scroll back | Scrolls back a page in a list. |
|  | Scroll to the beginning | Scrolls to the beginning of a list. |
|  | Scroll forward | Scrolls one page forward in a list. |
|  | Scroll to the end | Scrolls to the end of a list. |
|  | Enter key | <ul style="list-style-type: none"> Operates buttons. Accepts and ends an entry. Opens a drop down list box. Toggles within a text box between character mode and normal mode. <p>In character mode, a single character is selected. In this mode, you can advance in the character set using the cursor keys.</p> |

| Key | Functions | Description |
|---|-------------------------|---|
|  | Cancel | <ul style="list-style-type: none"> Deletes the characters of a value entry and restores the original value. Closes the active dialog. |
|  | Delete characters | Deletes the character to the right of the current cursor position. |
|  | Delete characters | Deletes the character to the left of the current cursor position. |
|  +  | Open drop down list box | Opens a drop down list box. |
|  +  | Accept value | Accepts the selected value in the drop down list box without closing the list. |

Enter key combinations

| Key | Functions | Purpose |
|---|--|--|
|  | Toggle key assignment | <p>Switches over key assignment of keys with multiple assignment.</p> <ul style="list-style-type: none"> No LED is illuminated: The number assignment is enabled. Pressing the button once toggles to letter assignment. An LED is lit: The left or right letter assignment is enabled. <p>Each time the key is pressed, the system toggles between the left letter assignment, the right letter assignment and the number assignment.</p> |
|  | Toggle between upper-case and lower-case | Used in key combinations, for example for entering upper-case letters. |
|  | Switch to additional key assignment | Some of the keys contain a blue imprinted key assignment, for example the "%" character. Used in key combinations for the blue key assignment. |
|  | General control function | Used in key combinations |
|  | General control function | Used in key combinations |

Acknowledge alarms

| Key | Functions | Description |
|---|-------------|--|
|  | Acknowledge | <p>Acknowledges the currently displayed fault alarm or all the alarms of an alarm group as group acknowledgment.</p> <p>The LED lights up as long as unacknowledged fault alarms are active.</p> |

Displaying infotext

| Key | Functions | Description |
|---|---------------------|--|
|  | Displaying infotext | Opens a window with the configured infotext at the selected object, e.g. alarm or I/O field. If an infotext exists for the selected object, the LED lights up. |





Multi-key operation

Unwanted actions may be triggered, if the operator unintentionally actuates a key combination.



| |
|--|
|  CAUTION |
| Unintentional actions |
| In "Online" mode, simultaneous operation of more than two keys may cause unintentional actions in the plant. |
| Never press more than two keys simultaneously. |

8.5.2 Example: Enter characters using the alphanumeric keyboard

Using the same keys of the alphanumeric keyboard you can enter up to six different characters. The entry result depends on the combination of the keys pressed.

The values "5", "M", "m", "N", "n" and "%" are entered using the same key  of the keyboard. You can use the keys ,  and  to switch between the different assignments..

The following table shows the entry options using the key .

| Key  | Key  | Key  | Result |
|---|---|--|--------|
| No LED is lit | Not relevant | Not pressed | 5 |
| Left LED is illuminated. | Not pressed | Not pressed | m |
| Left LED is illuminated. | Pressed | Not pressed | M |
| Right LED is illuminated. | Not pressed | Not pressed | n |
| Right LED is illuminated. | Pressed | Not pressed | N |
| Not relevant | Not relevant | Pressed | % |

8.5.3 Function keys

Function keys

Function key assignment is defined during configuration. The configuration engineer can assign function keys globally and locally.

Function keys with global function assignment

A globally assigned function key always triggers the same action on the HMI device or in the PLC irrespective of the screen displayed. Such an action could be, for example, the activation of a screen or the closure of an alarm window.

Function keys with local function assignment

A function key with local function assignment is screen-specific and is therefore only effective within the active screen.

The function assigned locally to a function key can vary from screen to screen.

The function key of a screen can be assigned one function only, either a global or local one. The local assignment function takes priority over the global setting.

The configuration engineer can assign function keys in such a way that you can operate operating elements with function keys, for example, the alarm view, trend view, recipe view or status / force.

8.5.4 General procedures

Introduction

The control keys and function keys of the HMI device are available for key control

General procedure

The operating elements of a screen are operated using the control keys of the HMI device.

Proceed as follows:

1. Continue to press the key  or the cursor keys until the required operating element is selected on the screen.
2. Depending on the operating element, perform further actions. Detailed descriptions can be found under the respective operating element.

Examples:

- I/O field: Enter numerical, alphanumeric or symbolic values in the I/O field
- Slider control: Move the slider control

3. Confirm the operation with the key  or abort the operation with the key .

8.5.5 Entering and editing numerical values

Formats for numerical values

You can enter values in numerical text boxes based on the following formats:

- Decimal
- Hexadecimal
- Binary

Limit value test of numerical values

Tags can be assigned limit values. If you enter a value that lies outside of this limit, it will not be accepted, for example, 80 with a limit value of 78. In this case the HMI device will deliver a system alarm, if an alarm window is configured. The original value is displayed again.

Procedure

Numerical and alphanumerical values can be entered in character mode using the system keys.

Proceed as follows:



1. Select the desired text box within the screen with .

The existing value is selected in the text box.

2. Enter the value using the numerical keypad.

You have the following options to enter a value:

- The existing value is deleted when you enter the first character. Completely reenter the value.
- Press  and a cursor key simultaneously. The selection of the field content is canceled. Move the cursor in the existing value. You can now edit the characters of the current value or add characters.

The  key deletes the character positioned to the right of the cursor. Use the  key to delete the character to the left of the cursor.

To enter the hexadecimal characters "A" to "F", switch the numerical keypad to letter assignment using the key .

- If the LED of the  key is lit, infotext is available for the selected object or the current screen.

Use the key  to display the infotext for the operating element or current screen.

3. Select  to confirm your entry.

Result

You have changed the numerical value or entered a new one.

8.5.6 Entering and editing alphanumerical values

Procedure

Alphanumerical values can be entered in character mode using the system keys.

Proceed as follows:



1. Select the desired text box within the screen with .

The existing value is selected in the text box.

2. Enter the value using the system keys.

You have the following options to enter a value:

- The existing value is deleted when you enter the first character. Completely reenter the value.
- Press  and a cursor key simultaneously. The selection of the field content is canceled. Move the cursor in the existing value. You can now edit the characters of the current value or add characters.

The  key deletes the character positioned to the right of the cursor. Use the  key to delete the character to the left of the cursor.

To enter letters, switch the numerical keypad to letter assignment using the key .

- If the LED of the  key is lit, infotext is available for the selected object or the current screen.

Use the key  to display the infotext for the operating element or current screen.

3. Select  to confirm your entry.

Result

You have changed the alphanumeric value or entered a new one.

8.5.7 Entering the date and time

Entering the date and time

Enter the date and time in the same way you enter alphanumerical values.

Note

When entering the date and time, please note that the format is determined by the configured project language.

See also

Entering and editing numerical values (Page 178)

Entering and editing alphanumerical values (Page 179)

8.5.8 Entering Symbolic Values

Selection list



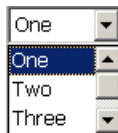



When you select a symbolic IO field, a selection list opens.



Procedure

Symbolic values are selected from the entries of a selection list.

Proceed as follows:

1. Select the desired symbolic text box within the screen with .
2. Open the selection list using the  key. The selection list opens.
3. Select the required entry using the cursor keys ,  or .
4. Confirm your entry with the  key.

Result

You have changed the symbolic value or entered a new one.

8.5.9 Displaying Infotext

Purpose

The configuration engineer uses info text to provide additional information and operating instructions. The configuration engineer can configure info text on screens and operator controls.

The infotext of an I/O field can contain, for example, information on the value to be entered.

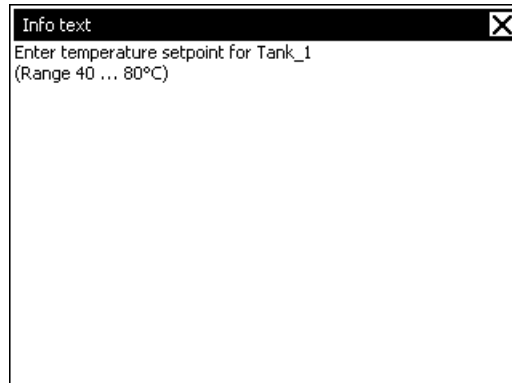



If the LED of the  key lights up, an infotext has been configured for the selected display object or for the current screen.

Procedure

1. Press .

The info text for the selected screen object is displayed. If there is no info text for the selected screen object, the info text for the current screen is displayed, if it has been configured.

You can scroll through the contents of long info texts using the cursor keys  and .

Note

Switching between displayed info text

The configuration engineer can configure infotext for an I/O field and the associated screen. You can switch between two infotexts by pressing the  key.

2. Close the infotext by pressing the  key.

Alternative procedure

Depending on your configuration, info text can also be called via a function key or via an existing operator control.

Refer to your plant documentation to find any available additional information on this topic.

8.6 Bar and gauge

Bar

The bar is a dynamic display object. The bar displays a value from the PLC as a rectangular area. The bar allows you to recognize the following at a glance:

- The distance of the current value from the configured limit values
- Whether a set point value has been reached

The bar can display values such as fill levels or batch counts.

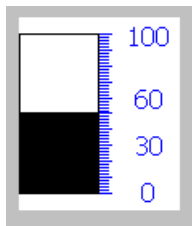

Layout

The layout of the bar depends on the configuration:

- The bar may feature a scale of values
- The configured limit values can be indicated by lines
- Color changes can signal when a limit value has been exceeded or has not been reached

Gauge

The gauge is a dynamic display object. The gauge displays numerical values in analog form by means of a pointer. This enables an operator at the HMI device to see at a glance if the boiler pressure is in the normal range, for example.

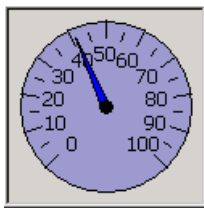

Layout

The layout of the gauge depends on the configuration:

- A trailing pointer can display the maximum value reached so far on the scale. The trailing pointer is reset when the screen is reloaded
- The label on the scale can show the measured variable, for example boiler pressure and the physical unit, for example bar

Operation

The bar and the gauge are for display only. Both objects cannot be controlled by the operator.

8.7 Operating the switch

Introduction

The switch is an operating element and display object with two predefined switching states, for example "On" and "Off". Switches can signalize the state of a plant section, for example if a motor is running or not. At the same time, you can use the switch to change the state of the corresponding plant section via the HMI device, for example from "On" to "Off".

Layout

The layout of the switch depends on the configuration:

- Switch with slider

The two states are displayed by the position of the slider

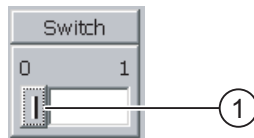

① Slider

- Switch with text or graphic

The two states are displayed by the label on the slider

Depending on the switching state, the switch is labeled with one of two texts or one of two graphics.

Examples:

"Backward" or "Forward"

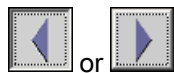

Procedure using the touch screen

- Switch with slider

Proceed as follows:

Move the slider to the other position or double-click the slider area

- Switch with text or graphic

Proceed as follows:

Touch the switch

Procedure using the keys

Proceed as follows:

1. Select the desired switch within the screen with .

2. Press .

Result

The switch changes its appearance. The associated value is switched.

8.8 Operating the Slider Control

Introduction

The slider control can be used to monitor and change process values within a defined range. The slider control can also be configured without a slider. In this case, you cannot enter a value. The slider control is then only used for displaying values.

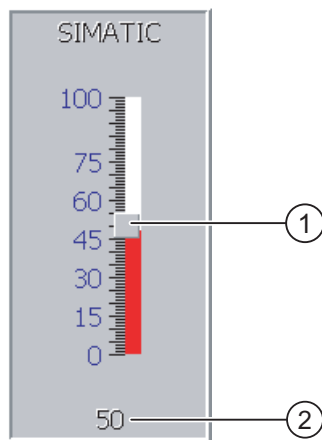

- ① Slider control for entering values
- ② Value display with current value

Layout

The layout of the slider control depends on the configuration:

- The slider control can contain a label and a setting range
- The current value can be displayed below the area of the slider control

Procedure using the touch screen

Proceed as follows:

1. Touch the slider of the desired slider control.
2. Move the slider to the required value.

If a value display has been configured, you can check the exact value that has been set.

3. Release the slider.

Key control

The following table shows the control keys used to set the slide to a desired value:

| Key combination | Description |
|----------------------------|----------------------------------|
| SHIFT + ▲ or SHIFT + ► | Increase value by 1 |
| SHIFT + ▼ or SHIFT + ◀ | Reduce value by 1 |
| ▲ HOME | Increase value in 5% increments. |
| ▼ END | Decrease value in 5% increments. |
| F _N + ▲ HOME | Set maximum value |
| F _N + ▼ END | Set minimum value |

Procedure using the keys

Proceed as follows:

1. Use the  key to select the desired slider control within the screen.
2. Move the slider to the required value.

If a value display has been configured, you can check the exact value that has been set.

Result

The set value is applied.

8.9 Operating the Trend View

Trends

Trends continuously display the current process data or process data from a log.

Trend view

Trends are displayed in the trend view. A trend view can display several trends simultaneously.

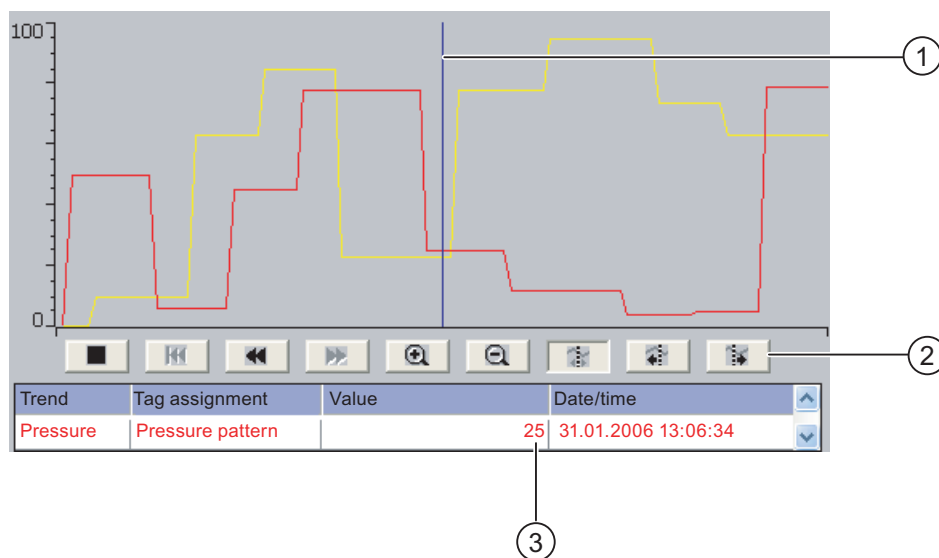

- ① Ruler
- ② Buttons for trend operation
- ③ Trend value in the value table

Layout and operation

The layout and operation of the trend view depends on the configuration. The configuration engineer determines the following, for example:

- Appearance of the trend view, the axes, value ranges and labels
- Operating options of the trend view
- Limits for the trend values
- The change of color of the trend in the event of limit violation

Refer to your plant documentation to find any available additional information on this topic.

Value table

The trend values can be read from the value table if this is configured:

- When the ruler is displayed, the trend values are shown at a position of the ruler in the value table
- When the ruler is hidden, the latest trend values are displayed in the value table

Ruler

When configured, a ruler is available to provide an exact reading of the trend values in the value table.

















You can move the ruler to the desired position of the trend view.

Operation

The trend view can be operated as follows:

- Enlarge or reduce the time interval displayed
- Scroll forward or back by one display width
- Stop and resume trend recording
- Move the ruler
- Hide and display the ruler

The following table shows the trend view buttons:

| Button | Key combination | Function |
|---|--|--|
|  | | Stops or continues trend recording. |
|  | CTRL +  | Enlarges the displayed time section. |
|  | CTRL +  | Reduces the displayed time section. |
|  | SHIFT +  | Scrolls one display width backward (to the left). |
|  | SHIFT +  | Scrolls one display width forward (to the right). |
|  | CTRL +  | Scrolls back to the beginning of the trend recording. The start values of the trend recording are displayed there. |
|  | CTRL + ALT +  | Moves the ruler backward (to the left). |
|  | CTRL + ALT +  | Moves the ruler forward (to the right). |
|  | | Shows or hides the ruler. |

In addition, the configuration engineer can configure function keys or operator controls with which you can control trend views.

Refer to your plant documentation to find any available additional information on this topic.



Touch operation

Touch the required button in the trend view.

The position of the ruler can also be changed by means of touching and dragging the ruler on the touch screen.

Procedure using the keys

Proceed as follows:

1. Use the  key to select the desired button within the trend view.
2. Confirm your entry by pressing the  key.

8.10 Operating the status force

8.10.1 Overview

Application

You read or write access values of the connected PLC directly with status force. Status force allows you to monitor or change addresses of the PLC program, etc. You don't need to connect an additional programming device or additional PC to the PLC.

Note

Status force can only be used in combination with SIMATIC S5 or SIMATIC S7.

Layout

The layout of status force depends on the configuration.

The figure shows the general layout of status force. A value can be monitored or controlled on every line.

The following figure shows an example of Status Force.

| Connection | Type | Offset | Format | Control Value |
|------------|------|--------|--------|---------------|
| PLC_1 | M | 120 | DEC | 33 |
| PLC_1 | T | 40 | T | 24,00 |
| PLC_1 | O | 50 | DEC | 0 |
| PLC_1 | O | 50 | HEX | 0A0D |

The configuration engineer specifies which columns appear in status force.



The table shows the significance of all configurable columns.

| Column | Functions |
|--------------------------------------|---|
| "Connection" | The PLC whose address ranges must be displayed. |
| "Type", "DB Number", "Offset", "Bit" | The address range of the value |
| "Data Type", "Format" | The data type of the value |
| "Status Value" | The value read from the specified address. |
| "Control Value" | The value to be written to the specified address. |

Further information on this may be available in your plant documentation

Operating elements

Depending on your configuration, you can operate the Status Force using the following buttons:

| Buttons | Functions |
|---|--|
|  | "Read" button Updates the display in the "Status Value" column. This button engages when it is pressed. You cannot operate any text boxes until the button is actuated again and the refresh is stopped. |
|  | "Write" button Applies the new value in the "Control Value" column. The control value is written to the PLC. |

8.10.2 Touch operation

Operator input options

Status Force can be operated as follows:

- Change the column sequence
- Read the status values of the connected PLC
- Enter values and transfer them to the PLC

Change column sequence

Depending on the configuration, you can change the column sequence of Status Force.

Proceed as follows:

1. Touch the column header which you wish to exchange with a different column header
2. Keeping the touch screen pressed, move the column heading to the column heading you wish to exchange it with

Result

The columns are displayed in the modified sequence.

Procedure for reading the status value

Proceed as follows:

1. Enter the address and the desired format of a value for each line. Touch the respective columns to display the screen keyboard.
2. Once you have entered all of the desired values, touch the  button.

Result

All values are read cyclically by the PLC and entered in the "Status value" column until the  button is touched again.

Requirements for forcing

The following requirements must be fulfilled in order to force values:

- The "Control value" column must be available
- The "Write" button must be available

Procedure for forcing a value

Proceed as follows:

1. Enter the address of a value for each line. Enter the desired value in the "Control value" column. Touch the respective columns to display the screen keyboard.
2. Once you have entered all of the desired values, touch the  button.

Result

The values from the "Control value" column are transferred once to the PLC.

8.10.3 Key control









Operator control options

Status force can be operated as follows:

- Change the column width.
- Read the status values of the connected PLC
- Enter values and transfer them to the PLC



Key control

The following table lists the key combinations for operating the status force:



| Keys | Functions |
|--|--|
| CTRL +  | Operates the "Read" button. |
| CTRL + ENTER | Operates the "Write" button. |
| CTRL +  CTRL +  | Selects the first/last field in the current line. |
| CTRL +  CTRL +  | Selects the first/last field in the current column. |
| CTRL +  | Deletes the current line. Otherwise: Do not select a PLC in the "Connection" column. |
| ENTER | Opens selection box. |
| CTRL + ALT +  | Increases the width of the current column. |
| CTRL + ALT +  | Decreases the width of the current column. |
| CTRL +  | Optimizes column width. |

Procedure for reading the status value

Proceed as follows:

1. Enter the address and format of the status value for each status value you wish to read in one line. Select the respective fields and enter the values using the keyboard.
2. Press  + .

Result

All status values are read cyclically from the PLC and entered in the "Status Value" column until the  +  keys are pressed again.



Requirements for forcing

The following requirements must be fulfilled in order to force values:

- The "Control Value" column must be available
- The "Write" button must be available

Procedure for forcing a value





Proceed as follows:

1. Enter the address of a value for each line. Enter the desired control value in the "Control Value" column. Select the respective fields and enter the values using the keyboard.
2. Once you have entered all of the desired control values, press the  +  key.

Result

The values from the "Control Value" column are transferred once to the PLC.

Alternative procedure

Alternatively, you can also select the buttons  and  using the key  and operate it using key .

8.11 Operating the Sm@rtClient view

8.11.1 Overview

Application

The Sm@rtClient view enables you to monitor and remotely operate the current project of a remote HMI device. With the correct configuration, several equal priority HMI devices can access a remote HMI device.

Note

If another HMI device accesses your HMI device via the Sm@rtClient view, this leads to an additional load on your HMI device.

Layout

In the Sm@rtClient view, the remote HMI is displayed with the complete layout.

Depending on the configuration, you can monitor and also operate this screen.

You can also operate the function keys like buttons on an HMI device with a touch screen.

Monitoring mode

On a Sm@rtClient view which is configured for monitoring mode, you can only monitor the remote HMI device. You cannot control its operation.

Operation

Note

It is not possible to operate the direct keys of the remote HMI device from the local HMI device.

The available operator controls depend on the HMI devices used:

- Same type of HMI devices
You can operate the project of the remote HMI device with the operator controls of your HMI device
- Operate keys from a local touch screen
All the keys of the remote HMI device are displayed as buttons on the touch screen. You can touch them to operate them.
- Touch operation from a local HMI device using keys
You operate the buttons in the usual manner.

8.11.2 Touch operation

Operator input options

The Sm@rtClient view can be operated as follows:

- Starting remote control
- Forcing permission
- Ending remote control

Procedure for starting remote control

Proceed as follows:

1. On the HMI device change to the screen with the Sm@rtClient view.

The following options are available for establishing the connection to the remote HMI device:

- The connection is established automatically.
- The connection must be established by touching the appropriate button.

Depending on the configuration, you may be required to enter the address of the remote HMI device and a password.

2. The current screen of the project running on the remote device is displayed on the screen of your HMI device.
3. You can now monitor or control this screen depending on your configuration.

Scroll bars are displayed if the screen of the remote HMI device is larger than that of the current HMI device.

Procedure for forcing permission

If several HMI devices have access to a HMI device, only one HMI device has operating permission at any one time.

Two cases must be distinguished for this case:

- If another HMI device is already controlling the remote HMI device, if configured accordingly, you can force operating permission for the remote HMI device
 - You are trying to operate the remote HMI device
 - A dialog appears in which you are prompted to enter the appropriate password for forcing remote control
 - You are now authorized to operate the remote HMI device
- If another HMI device is accessing your HMI device via the Sm@rtClient view, you can force local operating permission for your HMI device
 - Touch the screen of your HMI device five times consecutively
 - You are given permission to operate your local HMI device

Procedure for ending remote control

You can end monitoring and control of a remote HMI device with one of the following methods depending on the configuration:

- Touch a button configured for this action
- Exit the screen containing the Sm@rtClient view
- If configured, a menu is displayed after you have touched an empty space over a longer period. Select the "Close" menu item.

Please refer to your system documentation to check whether additional information on this subject is available there.

8.11.3 Key control

Operator control options

The Sm@rtClient view can be operated as follows:

- Starting remote control
- Forcing permission
- Ending remote control

Procedure for starting remote operation

Proceed as follows:





1. On the HMI device change to the screen with the Sm@rtClient view.

The following options are available for establishing the connection to the remote HMI device:

- The connection is established automatically.
- Continue to press the key  until the Sm@rtClient view is selected.

Depending on the configuration, you may be required to enter the address of the remote HMI device and a password.

The connection is established. The current screen of the project running on the remote device is displayed on the screen of your HMI device.

2. You can now monitor and control this screen depending on your configuration.
3. Scroll bars are displayed if the screen of the remote HMI device is larger than that of the current HMI device. Move the scroll bars in the direction required using keys  + 
or  + .

Procedure for forcing permissions

If several HMI devices access an HMI device, only one HMI device has permission to operate.

Two cases must be distinguished for this case:

- If another HMI device is already controlling the remote HMI device, if configured accordingly, you can force operating permission for the remote HMI device
 - You are trying to operate the remote HMI device
 - A dialog appears in which you are prompted to enter the appropriate password for forcing remote control
- If another HMI device is accessing your HMI device via the Sm@rtClient view, you can force local operating permission for your HMI device



You are now authorized to operate the remote HMI device

- Press  five times consecutively.

You are given permission to operate your local HMI device

Procedure for ending remote control

You can end monitoring or control of a remote HMI device with one of the following methods depending on the configuration:

- Press the key configured for this.
- Exit the screen containing the Sm@rtClient view
- If configured, display a menu with  + . Select the desired menu command with  and the respective identification letter.

Further information on this may be available in your plant documentation

8.12 Project security

8.12.1 Overview

Design of the security system

The configuration engineer can protect the operation of a project by implementing a security system.

The security system is based on authorizations, user groups and users.

If operating elements protected by a password are operated, the HMI device first requests that you log on. A logon screen is displayed in which you enter your user name and password. After logging on, you can operate the operating elements for which you have the necessary authorizations.

The logon dialog can be set up by the configuration engineer via an individual operating element.

In the same way, the configuration engineer can set up an operating element to log off. After logging off, objects assigned password protection can no longer be operated; to do so, log on again.

Further information on this may be available in your plant documentation

User groups and authorizations

Project-specific user groups are created by the configuration engineer. The "Administrators" and "PLC User" groups are included in all projects by default. User groups are assigned authorizations. Authorization required for an operation is specifically defined for each individual object and function in the project.

Users and passwords

Each user is assigned to exactly one user group.

The following people are allowed to create users and assign them passwords:

- The configuration engineer during configuration
- The administrator on the HMI device
- A user with user management authorization on the HMI device

Irrespective of the user group, each user is allowed to change his own password.

Logoff times

A logoff time is specified in the system for each user. If the time between any two user actions, such as entering a value or changing screens, exceeds this logoff time, the user is automatically logged off. The user must then log on again to continue to operate objects assigned password protection.

Backup and restore

The user data is encrypted and saved on the HMI device to protect it from loss due to power failure.

The users, passwords, group assignments and logoff times set up on the HMI device can be backed up and restored. This prevents you having to enter all of the data again on another HMI device.

| NOTICE |
|---|
| The currently valid user data is overwritten in the following cases: <ul style="list-style-type: none">• Depending on the transfer settings, when the project is transferred again• Upon restore of a backed-up project• Upon import of the user administration via an operating element. Further information on this may be available in your plant documentation The retransferred or restored user data and passwords are valid with immediate effect. |

Limits for user, password and user View

| | Number of characters |
|-------------------------------|----------------------|
| Length of user name, maximum | 40 |
| Length of password, minimum | 3 |
| Length of password, maximum | 24 |
| Entries in user view, maximum | 50 |

8.12.2 User view

Application

The user view is used to display the users on the HMI device:

- All users on the HMI device are displayed in the user view to the administrator or to a user with administrator authorizations
- If you are a user without user management authorization, you can only see your personal user entry

The authorizations of a user after logging on depends on the user group to which the user is assigned.

Please refer to your system documentation to check whether additional information on this subject is available there.

Layout

The configuration engineer can implement a simple or extended user view.

The two user views offer the same functions. They differ only in the display of information.

Simple user view

If you are not logged on to the HMI device, the only entry contained in the simple user view is "<ENTER>".

If you are logged on to the HMI device, the simple user view only displays the user name and user group.

| | |
|------------|-----------|
| Admin | Group (9) |
| PLC User | Group (1) |
| User 1 | Group (1) |
| <New user> | |

Extended user view

The extended user view displays information about the users.

| User | Password | Group | Logoff time |
|----------|----------|-----------|-------------|
| Admin | ***** | Group (9) | 5 |
| PLC User | ***** | Group (1) | 5 |
| User 1 | ***** | Group (1) | 5 |
| | | | |

The extended user view contains the following columns:

- Users
- Password
- Group
- Logoff time

The passwords are encrypted by appearing as asterisks.

8.12.3 User logon

Logon dialog

Use the logon dialog to log on to the security system of the HMI device. Enter your user name and password in the logon dialog.

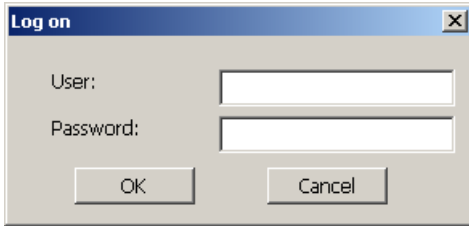

The logon dialog opens in the following cases:

- You press an operating element with password protection
- You press an operating element that was configured for displaying the logon dialog
- Select the "<ENTER>" entry in the simple user view
- Select a blank entry in the extended user view
- The logon dialog will be automatically displayed when the project is started, depending on the configuration

Please refer to your system documentation to check whether additional information on this subject is available there.

Requirements

The logon dialog is open.

Procedure using the touch screen

Proceed as follows:

1. Enter the user name and password.
Touch the corresponding text box. The alphanumerical screen keyboard is displayed.
2. Select "OK" to confirm logon.

Procedure using the keys

Proceed as follows:

1. Using the key  select the "User" text box within the logon dialog.
2. Enter the user name using the system keys.

To enter letters, switch the numerical keypad to letter assignment using the key .

3. Using the key  select the "Password" text box.
4. Enter the password using the system keys.
5. Touch the "OK" button to confirm your entries.

Note

The user name is not case-sensitive.

The password is case-sensitive.

Result

After successful logon to the security system, you can execute password-protected functions on the HMI device for which you have authorizations.

If you enter a wrong password, an error message is displayed when an alarm window has been configured.

8.12.4 User logoff

Requirements

You have logged into the security system of the HMI device.

Procedure

You have the following options for logging off:

- You press an operating element that was configured for logoff
- You will be logged off automatically if you are not operating the project and if the logoff time has been exceeded

You will also be automatically logged off if you enter an incorrect password.

Result

You are no longer logged into the project. In order to activate an operating element with password protection, you must first log on again.

8.12.5 Creating users

8.12.5.1 Creating users with touch operation

Requirements

You have opened a screen containing the user view.

You have user management authorization or you are the administrator.

NOTICE

The following characters cannot be used in passwords:

- Blank
- Special characters * ? . % / \ ' "

Procedure for creating a user in the simple user view

Proceed as follows:

1. Touch the "<New User>" entry in the user view.

The following dialog opens:

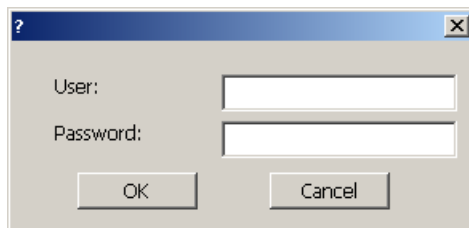

2. Enter the desired user name and password.



Touch the corresponding text box. The alphanumerical screen keyboard is displayed.

3. Touch the "OK" button.

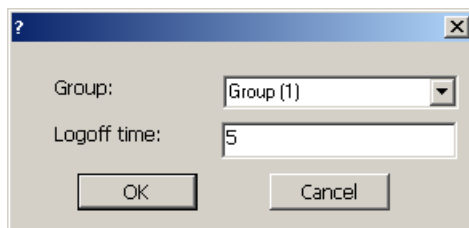
The following dialog opens:



4. Assign the user to a group.

In order to do so, open the "Groups" drop down list by means of the  button. Select  and  to scroll in the drop down list box.

5. Touch the required entry in the drop down list box.
The selected entry is then accepted as input.
6. Touch the text box "Logoff time". The screen keyboard is displayed.
7. Enter a value between 0 and 60 for the logoff time in minutes. The value 0 stands for "no automatic logoff."
8. Touch the "OK" button to confirm your entries.

Procedure for creating a user in the enhanced user view

Proceed as follows:

1. Touch the desired field in the blank line of the user view.
The appropriate screen keyboard is displayed.
2. Switch into input mode by means of the  key.
3. Enter the respective user data in the field:
 - Assign the user to one of the groups from the drop down list box.
 - Enter a value between 0 and 60 for the logoff time in minutes. The value 0 stands for "no automatic logoff."

Result

The new user is created.

8.12.5.2 Creating users with key operation

Requirements



You have opened a screen containing the user view.

You have user management authorization or you are the administrator.

| NOTICE |
|--|
| The following characters cannot be used in passwords: <ul style="list-style-type: none">• Blank• Special characters * ? . % / \ ' " |

Procedure for creating a user in the simple user view

Proceed as follows:

1. Select the user view using the key  or using the cursor keys.
2. Select the entry "<New user>" in the user view with the cursor keys and confirm with .



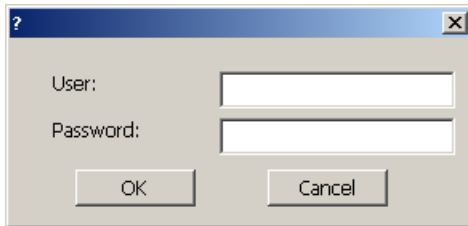



The following dialog opens:

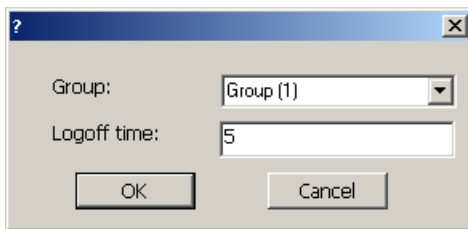

3. Enter the desired user name using the system keys.
4. Select the next text box with the  key and enter a password using the system keys.
5. Touch the "OK" button to confirm your entries.

The following dialog opens:













6. Select the "Group" selection box with .
7. Assign the user to a group.
 - Select  to open the drop down list box. The drop down list box opens.
 - Select the required entry using  or .
 - Confirm your entry by pressing the key .
8. Select the text box "Logoff time" with .
9. Enter the desired logoff time using the system keys.

Enter a value between 0 and 60 for the logoff time in minutes. The value 0 stands for "no automatic logoff."
10. Touch the "OK" button to confirm your entries.

Procedure for creating a user in the enhanced user view

Proceed as follows:

1. Select the user view with the  key via the configured tab order.
2. Select a blank line with the  or  keys.
3. Select the desired field in the blank line of the user view with the  or  keys.
4. Confirm your entry by pressing the key .
5. Enter the desired user data:
 - Enter the data using the system keyboard. To enter letters, switch the numerical keypad to letter assignment using the key .
 - Assign the user to one of the groups from the drop down list box. Open the drop down list box with the  key and select the desired entry with the  or  keys.
 - Enter a value between 0 and 60 for the logoff time in minutes. The value 0 stands for "no automatic logoff."
6. Confirm your entry by pressing the key .

Result

The new user is created.

8.12.6 Changing user data

8.12.6.1 Changing user data with touch operation

Requirements

You have opened a screen containing the user view.

Which data you are allowed to change depends on your authorization:

- You are an administrator or a user with user management authorization. In these cases you are allowed to change the data for all the users on the HMI device in the user view:
 - User name
 - Group assignment
 - Password
 - Logoff time
- You are a user without user management authorization. In this case you are only allowed to change your personal user data:
 - Password
 - Logoff time, if configured

Note

You can only change the logoff time and password for the "Admin" user.

You can only change the logoff time for the "PLC_User". This user is used for logging on via the PLC

Procedure for changing user data in the simple user view

Proceed as follows:

1. In the user view, touch the user whose user data you want to change
2. When entering the data, use exactly the same procedure as for creating a user

Procedure for changing user data in the extended user view

Proceed as follows:

1. In the user view, touch the user whose user data you want to change
2. When entering the data, use exactly the same procedure as for creating a user

Result

The user data for the user is changed.

8.12.6.2 Changing user data with key operation

Requirements

You have opened a screen containing the user view.

Which data you are allowed to change depends on your authorization:

- You are an administrator or a user with user management authorization. In these cases you are allowed to change the data for all the users on the HMI device in the user view:
 - User name
 - Group assignment
 - Password
 - Logoff time
- You are a user without user management authorization. In this case you are only allowed to change your personal user data:
 - Password
 - Logoff time, if configured



Note

You can only change the logoff time and password for the "Admin" user.

You can only change the logoff time for the "PLC_User". This user is used for logging on via the PLC



Procedure for changing user data in the simple user view

Proceed as follows:

1. Confirm your entry by pressing the key .
2. In the user view, use the cursor keys to select the user whose user data you want to change. Confirm your entry by pressing the key .
3. When entering the data, use exactly the same procedure as for creating a user

Procedure for changing user data in the enhanced user view

Proceed as follows:

1. Confirm your entry by pressing the key .
2. Use the cursor keys to select the field in which you want to change data. Confirm your entry by pressing the key .
3. When entering the data, use exactly the same procedure as for creating a user

Result

The user data for the user is changed.

8.12.7 Deleting users

Requirements

You have opened a screen containing the user view.

To delete a user, you must be an administrator or have user management authorization.

Note

The "Admin" and "PLC_User" users exist by default. These users cannot be deleted.

Procedure

To delete a user, delete the user name entered.

Result

The user has been deleted and may no longer log onto the project.

8.13 Closing the project

Procedure

Proceed as follows:

1. Use the corresponding operating element object to close the project.
Wait for the Loader to open after you closed the project.
2. Switch off power to the HMI device.

Operating alarms

9.1 Overview

Alarms

Alarms indicate events and states on the HMI device which have occurred in the system, in the process or on the HMI device itself. A status is reported when it is received.

An alarm could trigger one of the following alarm events:

- Incoming
- Outgoing
- Acknowledge

The configuration engineer defines which alarms must be acknowledged by the user.

An alarm may contain the following information:

- Date
- Time
- Alarm text
- Location of fault
- State
- Alarm class
- Alarm number
- Alarm group
- Diagnostics capability

Alarm classes

Alarms are assigned to various alarm classes:

- Error
Alarms in this class must always be acknowledged. Error alarms normally indicate critical errors within the plant such as "Motor temperature too high"
- Operation
Warning alarms usually indicate states of a plant such as "Motor switched on"
- System
System alarms indicate states or events which occur on the HMI device
- SIMATIC diagnostic alarms
SIMATIC diagnostic alarms show states and events of the SIMATIC S7 or SIMOTION PLCs
- User-specific alarm classes
The properties of this alarm class must be defined in the configuration

Please refer to your system documentation to check whether additional information on this subject is available there.

Alarm groups

The configuration engineer can group alarms into alarm groups. When you acknowledge an individual alarm of an alarm group, you acknowledge all alarms which belong to the same alarm group.

Alarm buffer

The alarm events are stored in an internal buffer. The size of this alarm buffer depends on the HMI device type.

Alarm report

The configuration engineer can activate alarm reporting on the project. In this case, alarm events are output directly on the connected printer.

The configuration engineer can define whether each individual alarm is logged. An alarm of this type is printed when the alarm events "Incoming" and "Outgoing" occur.

If you want to print alarms of the "System" alarm class, you have to print the contents of the associated alarm buffer. For this case the configuration engineer has to configure an operating element for printing the alarm buffer.

Alarm log

Alarm events are stored in an alarm log, provided this log file is configured. The capacity of the log file is limited by the storage medium and system limits.

9.2 Recognizing Pending Alarms

Introduction

You can recognize the presence of alarms which must be acknowledged by the following:

- For an HMI device with keys: The LED in the  key lights up.
- Depending on the configuration: An alarm indicator is displayed on screen.

The configuration determines whether an alarm has to be acknowledged or not. This is also defined by the alarm class which an alarm belongs to.

LED in the "ACK" key

On an HMI device with keys, an LED is integrated in the  key. The LED is lit if there are alarms requiring acknowledgment which must still be acknowledged.

The LED goes out when you acknowledge all alarms requiring acknowledgment.

Alarm indicator

The alarm indicator is a graphic symbol indicating pending alarms or alarms requiring acknowledgment, depending on the configuration.



The alarm indicator flashes as long as alarms are pending for acknowledgment. The number displayed indicates the number of pending alarms. The configuration engineer can assign functions to be executed when the alarm indicator is operated.

Usually, the alarm indicator is only used for error alarms. Refer to your system documentation to check whether additional information on this subject is available there.

9.3 Displaying alarms

Displaying alarms

Alarms are displayed in the alarm view or in the alarm window on the HMI device.

Alarm view

Depending on the configuration, the alarm view is displayed as follows:

- As a single line. Alarm numbers and alarm texts are displayed as single lines
- As simple alarm view
- As extended alarm view

In the simple or extended alarm views the configuration engineer specifies the alarm information to be displayed.

Depending on the configuration, alarms from alarm logs are also displayed in the alarm view.

Simple alarm view

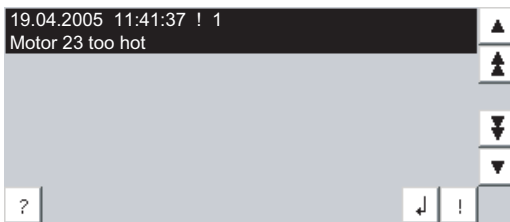



The buttons have the following functions:

| Buttons | Functions |
|---------|--|
| | Displaying infotext for an alarm. |
| | Process alarm. |
| | Acknowledge alarm. |
| | Select the next or previous alarm in the list. |
| | Scroll one page up or down. |

Extended alarm view

| No. | Time | Date | Status |
|------------------|----------|------------|--------|
| ! 1 | 12:04:59 | 19.04.2005 | K |
| Motor 23 too hot | | | |

The buttons have the following functions:

| Buttons | Functions |
|---|-----------------------------------|
|  | Displaying infotext for an alarm. |
|  | Process alarm. |
|  | Acknowledge alarm. |

Changing the column sequence and sorting in the extended alarm view

Depending on the configuration, you can change the column sequence and sorting order on HMI devices with touch operation.

- Change column sequence
 - Touch the column header which you wish to exchange with a different column header
 - Keeping the touch screen pressed, move the column heading to the column heading you wish to exchange it with
- Change sorting order

To change the sorting order of the alarms, touch the respective column header on the touch screen

Alarm class layout

The various alarm classes are identified in order to distinguish between them in the alarm view.

| Symbol | Alarm class |
|---------------------------------------|---------------------------------------|
| ! | Error |
| Without a symbol | Operation |
| Symbol depending on the configuration | User-defined alarm classes |
| S7 | SIMATIC or SIMOTION diagnostic alarms |
| \$ | System |

The configuration engineer can change the symbols for the alarm classes. Please refer to your system documentation to check whether additional information on this subject is available there.

Alarm window

The alarm window is independent of the process screen. Depending on the configuration, the alarm window opens automatically as soon as a new alarm is pending for acknowledgment. The alarm window can be configured so that it only closes after all the alarms have been acknowledged.

The layout and the operation of the alarm window are the same as for the alarm view.

Please refer to your system documentation to check whether additional information on this subject is available there.

9.4 Display infotexts for an alarm

Displaying infotext

The configuration engineer can also provide infotext for alarms.

Procedure using the touch screen

Proceed as follows:

1. Touch the desired alarm in the alarm view or the alarm window.

The alarm is selected.

2. Touch the  button in the simple alarm view or  in the enhanced alarm view.

If configured, the infotext assigned to this alarm is displayed.

3. Close the screen for displaying the Infotext by means of the  button.

Procedure using the keys

Proceed as follows:

1. Select the desired alarm in the alarm view.

2. Press .

If configured, the infotext assigned to this alarm is displayed.

3. Close the infotext by pressing key .

See also

Displaying alarms (Page 212)

9.5 Acknowledge alarm

Requirements

The alarm to be acknowledged is displayed in the alarm window or the alarm view.

Procedure using the touch screen

Proceed as follows:







1. Touch the desired alarm in the alarm view or the alarm window.

The alarm is selected.

2. Touch the  button in the simple alarm view or  in the enhanced alarm view.

Procedure using the keys

The alarm view and the alarm window have a tab sequence with which you can select operating elements and the last selected alarm using the keyboard.

1. Select the desired alarm view or alarm window with .
2. Select the desired alarm. Use the , ,  or  keys.
3. Press .

Alternative operation

Depending on the configuration, you can also acknowledge an alarm with a function key.

Result

The alarm is acknowledged. If the alarm belongs to an alarm group, all the alarms of the associated group are acknowledged.

More information on acknowledgment and on available alarm groups may be found in your plant documentation.

See also

Displaying alarms (Page 212)

9.6 Edit alarm

Introduction

The configuration engineer can assign additional functions to each alarm. These functions are executed when the alarm is processed.

Note



When you edit an unacknowledged alarm, it is acknowledged automatically.

Requirements

The alarm to be edited is displayed in the alarm window or the alarm view.









Procedure using the touch screen

Proceed as follows:

1. Touch the desired alarm in the alarm view or the alarm window. The alarm is selected.
2. Touch the  button in the simple alarm view or  in the enhanced alarm view.

Procedure using the keys

Proceed as follows:

1. Select the desired alarm view or alarm window with .
2. Select the desired alarm. Use the , ,  or  keys.
3. Continue to press the key  until the button  is selected in the simple alarm view or  in the extended alarm view.
4. Confirm your entry by pressing the key .

Result

The system executes the additional functions of the alarm. Further information on this may be available in your plant documentation

See also

Displaying alarms (Page 212)

Operating recipes

10.1 Overview

Introduction

Recipes are used when different variants of a product are manufactured with the same process. In this case, the product variants differ in terms of their type and quantity of the components, but not in terms of the manufacturing process sequence. The configuration engineer can store the combination of each individual product variant in a recipe.

Field of application

Recipes can be used everywhere the same product components are used in variable combinations to create different product variants.

Examples:

- Beverage industry
- Food processing industry
- Pharmaceutical industry
- Paint industry
- Building materials industry
- Steel industry

10.2 Structure of a recipe

Recipes

The recipe collection for the production of a product family can be compared to a file cabinet. A recipe which is used to manufacture a product corresponds to a drawer in a file cabinet.

Example:

In a plant for producing fruit juice, recipes are required for different flavors. There is a recipe, for example, for the flavors orange, grape, apple and cherry.

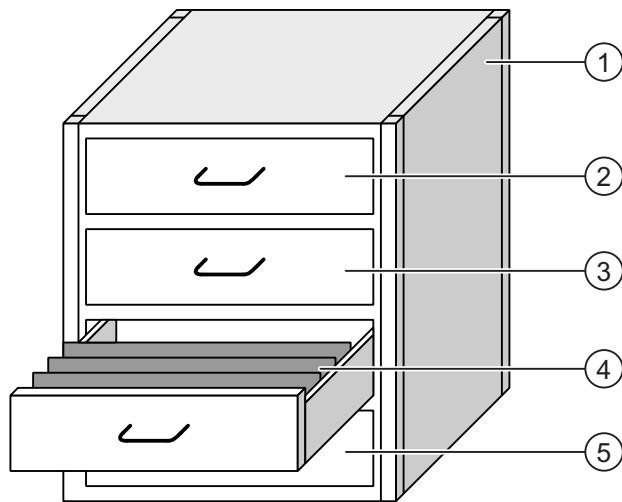

| | | | |
|---|--------------|-------------------|---------------------------------|
| ① | File cabinet | Recipe collection | Recipes for a fruit juice plant |
| ② | Drawer | Recipe | Orange flavored drinks |
| ③ | Drawer | Recipe | Grape flavored drinks |
| ④ | Drawer | Recipe | Apple flavored drinks |
| ⑤ | Drawer | Recipe | Cherry flavored drinks |

Recipe data records

The drawers of the file cabinet are filled with suspension folders. The suspension folders in the drawers represent records required for manufacturing various product variants.

Example:

Product variants of the flavor apple might be a soft drink, a juice or nectar, for example.

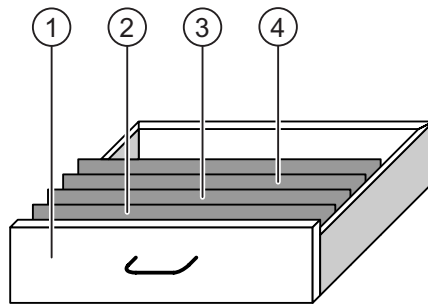

| | | | |
|---|-------------------|--------------------|---|
| ① | Drawer | Recipe | Product variants of apple flavored drinks |
| ② | Suspension folder | Recipe data record | Apple drink |
| ③ | Suspension folder | Recipe data record | Apple nectar |
| ④ | Suspension folder | Recipe data record | Apple juice |

Elements

In the figure showing the file cabinet, each suspension folder contains the same number of sheets. Each sheet in the suspension folder corresponds to an element of the recipe data record. All the records of a recipe contain the same elements. The records differ, however, in the value of the individual elements.

Example:

All drinks contain the same components: water, concentrate, sugar and flavoring. The records for soft drink, fruit juice or nectar differ, however, in the quantity of sugar used in production.

10.3 Recipes in the project

Overview

If recipes are used in a project, the following components interact:

- Recipe view / recipe screen

On the HMI device, recipes are displayed and edited in the recipe view or in a recipe screen.

- The recipe data records from the internal memory of the HMI device are displayed and edited in the recipe view.
- The values of the recipe tags are displayed and edited in the recipe screen.

Depending on the configuration, the values displayed in the recipe view are synchronized with the values of recipe tags.

- HMI device recipe memory

Recipes are saved in the form of data records in the HMI device recipe memory.

The recipe data can also be saved in recipe tags.

- Recipe tags

The recipe tags contain recipe data. When you edit recipes in a recipe screen, the recipe values are stored in recipe tags. Depending on the configuration, the values of the recipe tags are exchanged with the PLC.

The recipe tags can be synchronized with the recipe data records so that the same values are saved in both.

- Memory card

The memory card is an external storage medium for recipe data records. The recipe data records are exported from the HMI device recipe memory and are saved on the memory card in a *.csv file. The records can be reimported from the memory card to the recipe memory.

Data flow

The following figure shows the data flow in a project with recipes.

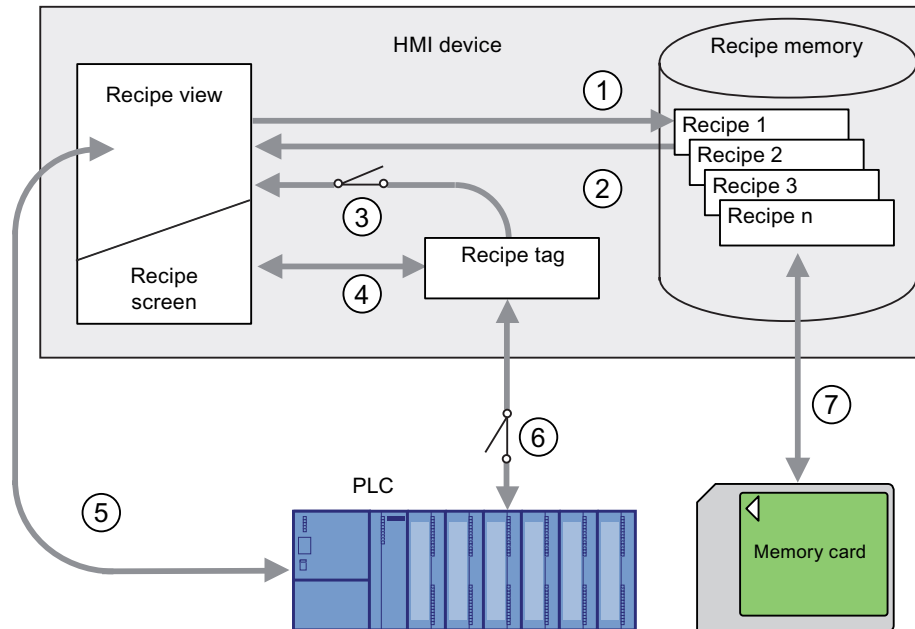

- ① Editing, saving or deleting a recipe data record
- ② Display recipe data record
- ③ Synchronize or do not synchronize recipe tags
- ④ Display and edit recipe tags in the recipe screen
- ⑤ Write records from the recipe view to the PLC or read records from the PLC and display them in the recipe view
- ⑥ Recipe tags are sent to the PLC online or offline
- ⑦ Export or import recipe data record to memory card

10.4 Displaying a recipe

Displaying recipes

You can display and edit recipes on the HMI device with a recipe view or recipe screen.

Recipe view

A recipe view is a screen object used to manage recipe data records. The recipe view shows recipe data records in tabular form.

Depending on the configuration, the recipe view is displayed as follows:

- As enhanced recipe view
- As simple recipe view

The configuration engineer also defines which operating elements are displayed in the recipe view.

Enhanced recipe view

The following figure shows an example of the enhanced recipe view.

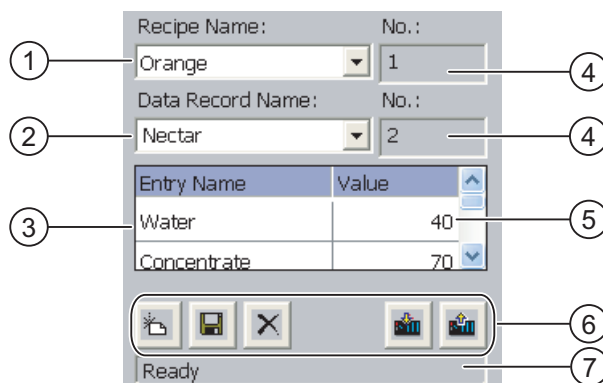

- ① Selection box for the recipe
- ② Selection box for the recipe data record
- ③ Element name
The element name designates a specific element in the recipe data record
- ④ Display field
This show the number of the selected recipe or the selected recipe data record
- ⑤ Value of the element
- ⑥ Buttons for editing a recipe data record
- ⑦ Status bar for display of the status messages

Simple recipe view

The simple recipe view consists of three areas:

- Recipe list
- Record list
- Element list

In the simple recipe view, each area is shown separately on the HMI device. Depending on the configuration, the simple recipe view starts with the recipe list or data record list.

The following figure shows an example of the record list.

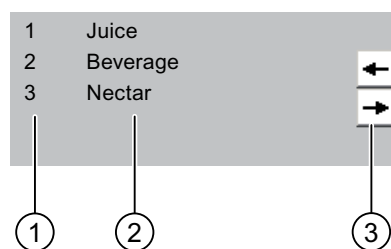

- ① Number of the recipe data record
- ② Recipe data records
- ③ Buttons for changing the displayed list and calling the menu

Display of values

NOTICE

Changing the recipe data record in the background

Applies to the processing of a recipe data record:

If values of the corresponding recipe data record are changed by a PLC job, the recipe view is not updated automatically.

To update the recipe view, reselect the respective recipe data record.

Recipe screen

A recipe screen allows the correlation between the plant and the recipe data to be displayed in graphic form. The configuration engineer combines I/O fields and screen objects to form a custom input screen. The configuration engineer can distribute the I/O fields of a recipe over several recipe screens, thus allowing recipe elements to be arranged by subject. The recipe screen can be operated using buttons configured accordingly.

The following figure shows an example of the recipe screen.

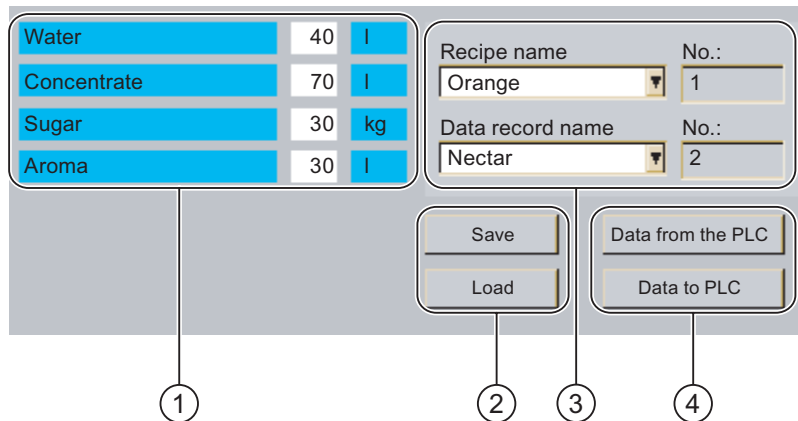

- ① Element name and associated values
The element name designates a specific element in the recipe data record
- ② Buttons for editing a recipe data record
- ③ Modified recipe view
- ④ Buttons for transferring recipe data

The values displayed or entered in the recipe screen are saved in recipe tags. The recipe values are exchanged with the PLC immediately or later via these tags.

A configured recipe view can itself be a component of a recipe screen. You must synchronize the tags in order to synchronize data between the tags of the recipe screen and the recipe data records displayed in the recipe view. Synchronization of tags is only possible in the enhanced recipe view.

Further information on this may be available in your plant documentation

10.5 Recipe values in the HMI device and the PLC

Introduction

You can change the values of a recipe on the HMI device and therefore influence the manufacturing process or a machine.

Depending on the configuration, the recipe values are displayed, edited and saved in different ways:

- If you are editing recipes with a recipe view in your project, the values are saved in recipe data records
- If you are editing recipes in a recipe screen in your project, the values are saved in recipe tags

Differences may occur between the display values in the recipe view and the values saved in the associated tags in an ongoing project when you edit recipes with a recipe view and in a recipe screen. To prevent this, the recipe data record values must be synchronized with the values of the recipe tags.

You have however the option to perform synchronization operations at any time. Synchronization only takes place if the configuration engineer has activated the respective settings for a recipe.

Note

Recipe tags can only be synchronized in the extended recipe view.

Synchronizing recipe tags

Synchronization of the recipe tags depends on the configuration:

- Automatic synchronization:

The values of the recipe view are synchronized with the associated recipe tags. In this case, changes to values in the recipe view have an immediate effect on the values of the associated recipe tags. The values are only synchronized, when an operating element that is outside the recipe view is operated.

- Synchronization by the user:

The values of the recipe view and the associated recipe tags are not synchronized automatically. The configuration engineer has assigned the same function to the  button or a different operating element in the recipe view. The recipe tags and the recipe view are only synchronized when you operate the buttons or the appropriate operating element.

Recipe tags online / offline

The configuration engineer can configure a recipe so that changes to the values of the recipe tags do not have an immediate effect on the current process.

Synchronization of the recipe values between the HMI device and the PLC depends on whether the configuration engineer has selected the settings "Tags online" or the setting "Tags offline" for a recipe.

- "Tags online":

This setting has the following effect:

- When you change recipe values in the recipe screen, these changes are applied immediately by the PLC and immediately influence the process
- If recipe values are changed in the PLC, the changed values are displayed immediately in the recipe screen

- "Tags offline":

With this setting, changed recipe values are not synchronized immediately between the HMI device and the PLC

In this case, the configuration engineer must configure operating elements for transferring the values to the PLC or reading them from the PLC in a recipe screen. The recipe values are only synchronized between HMI device and PLC when you operate the appropriate operating element

10.6 Operating the recipe view

10.6.1 Overview









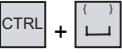

Operation

The recipe view can be operated as follows:

- Enter values for the recipe elements
- Create recipe data records
- Save recipe data records or save them under a new name
- Delete recipe data records
- Synchronize values of the recipe view with the associated recipe tags
- Transfer recipe data records from the PLC and to the PLC

Operating elements of the recipe view

The following table shows the operating elements of the recipe view.

| Buttons | Key combination | Functions |
|---|--|---|
|  | CTRL +  | Creates a new recipe data record. If a start value is configured, it is shown in the text box. |
|  | CTRL + ENTER | Saves the displayed values of the recipe data record. The storage location is predefined by the project. |
|  | CTRL + * | The recipe data record is saved under a different name irrespective of the recipe view. A dialog box opens in which the name is entered. |
|  | CTRL +  | The displayed recipe data record is deleted. |
|  | CTRL + = | The values of the recipe view are synchronized with the associated recipe tags. The values changed during editing are written to the associated recipe tags. Subsequently all the values of the tags are read out and updated in the table. |
|  | CTRL +  | The recipe values from the PLC are displayed in the recipe view. |
|  | CTRL +  | The values of the set recipe data record displayed in the recipe view are transferred to the PLC. |

Operating the recipe screen

You operate the recipes in a recipe screen with the operating elements provided by the configuration engineer.

Further information on this may be available in your plant documentation

10.6.2 Creating a recipe data record

Introduction

You create a new recipe data record by modifying an existing record. You then save the modified data record under a new name.

Requirements

A screen with a recipe view is displayed

Procedure using the touch screen

Proceed as follows:

1. If the recipe view contains several recipes: Select the recipe for which you want to create a new recipe data record.

2. Touch .

A new recipe data record with the next available number is created.

If you change the new data record number to an existing data record number, the existing data record is overwritten.

3. Enter values for the elements of the data record.

The elements of the recipe data record can be assigned default values depending on the configuration.

4. Touch .

5. Enter a name for the data record.

The data record is saved under the new name.

If the recipe data record already exists, a dialog is opened. In this dialog, specify whether the existing data record is to be overwritten.

Procedure using the keys

Proceed as follows:

1. If the recipe view contains several recipes: Select the recipe for which you want to create a new recipe data record.

2. Press  + .

A new recipe data record with the next available number is created.

If you change the new data record number to an existing data record number, the existing data record is overwritten.

3. Enter values for the elements of the data record.

The elements of the recipe data record can be assigned default values depending on the configuration.

4. Press  + .

5. Enter a name for the data record.

6. Confirm your entry.

The data record is saved under the new name.

If the recipe data record already exists, a dialog is opened. In this dialog, specify whether the existing data record is to be overwritten.

Result

The new recipe data record is saved to the selected recipe.

See also

Recipes in the project (Page 220)

10.6.3 Editing a recipe data record

Introduction

Edit the values of the recipe data records and save them in a recipe view.

Synchronization with the PLC

If you want to display the current recipe values from the PLC in the recipe view, you first have to read the current values from the PLC with .

The values changed in the recipe view only become effective when the amended data record is transferred to the PLC by means of the  button.

Requirements

A screen with a recipe view is displayed

Procedure using the touch screen

Proceed as follows:



1. If the recipe view contains several recipes: Select the recipe which contains the desired recipe data record.
2. Select the recipe data record you want to change.
3. Change the data record as required.
4. Save your changes by means of the  button.



If you want to save the recipe data record under a different name, touch the  key.

5. The recipe data record is saved.

Procedure using the keys

Proceed as follows:

1. If the recipe view contains several recipes: Select the recipe which contains the desired recipe data record.
2. Select the recipe data record you want to change.
3. Change the data record as required.
4. Save your changes with  + .

If you want to save the recipe data record under a different name, press  + .

The recipe data record is saved.

Result

The edited recipe data record has now been saved in the selected recipe.

See also

Recipes in the project (Page 220)

10.6.4 Deleting a recipe data record

Introduction

You can delete all the data records of a recipe which are not required.

Requirements

A screen with a recipe view is displayed



Procedure using the touch screen

Proceed as follows:

1. If the recipe view contains several recipes: Select the recipe which contains the desired recipe data record.
2. Select the recipe data record you want to delete.
3. Touch .

Procedure using the keys

Proceed as follows:

1. If the recipe view contains several recipes: Select the recipe which contains the desired recipe data record.
2. Select the recipe data record you want to delete.
3. Press  + .

Result

The recipe data record is deleted.

See also

Recipes in the project (Page 220)

10.6.5 Synchronizing tags

Introduction

The values of the recipe elements can be saved to recipe tags, depending on the configuration.

Differences may occur between the display values in the recipe view and the actual values of tags in an ongoing project. Synchronize the tags to equalize such differences.

Synchronization always includes all the variables which belong to a recipe data record.

| |
|--|
| NOTICE |
| Changed tag name |
| Tags and the value of the recipe data record cannot be assigned to each other if the tag name of the tag to be synchronized has been changed. The tags in question are not synchronized. |

Note

Recipe tags can only be synchronized in the enhanced recipe view.

Requirements

A screen with a recipe view is displayed



Procedure using the touch screen

Proceed as follows:

1. If the recipe view contains several recipes: Select the recipe which contains the desired recipe data record.
2. Select the recipe data record you want to synchronize.
3. Touch .

Procedure using the keys

Proceed as follows:

1. If the recipe view contains several recipes: Select the recipe which contains the desired recipe data record.
2. Select the recipe data record you want to synchronize.
3. Press  + .

Result

The elements of the recipe data record are synchronized with the recipe tags.

If the values of the recipe view and the tag do not match, the more current value is accepted.

See also

Recipes in the project (Page 220)

10.6.6 Reading a recipe data record from the PLC

Introduction

In the current project, the values which are also stored in the recipes in the HMI device can be changed directly in the plant. This is the case, for example, if a valve was opened further directly at the plant than is stored in the recipe. The values of the recipe data records saved in the HMI device possibly no longer match the values in the PLC.

To synchronize the recipe values, read the values from the PLC and display them in the recipe view.

Requirements

A screen with a recipe view is displayed

Procedure using the touch screen

Proceed as follows:

1. If the recipe view contains several recipes: Select the recipe which contains the desired recipe data record.
2. Select the recipe data record to which you want to apply the values from the PLC.

3. Touch .

The values are read from the PLC.

4. If you want to store the displayed values in the HMI device, touch the  button.



Procedure using the keys

Proceed as follows:

1. If the recipe view contains several recipes: Select the recipe which contains the desired recipe data record.
2. Select the recipe data record to which you want to apply the values from the PLC.

3. Press  + .

The values are read from the PLC.

4. If you want to store the displayed values in the HMI device, press the keys  + .

Result

The values were read from the PLC, displayed on the HMI device and saved to the selected recipe data record.

See also

Recipes in the project (Page 220)

10.6.7 Transferring a recipe data record to the PLC

Introduction

In order for an edited recipe data record to take effect in the process, you must transfer the values to the PLC.

The display values in the recipe view are always transferred to the PLC.

Requirements

A screen with a recipe view is displayed



Procedure using the touch screen

Proceed as follows:

1. If the recipe view contains several recipes: Select the recipe which contains the desired recipe data record.
2. Select the recipe data record whose values you want to transfer to the PLC.
3. Touch .

Procedure using the keys

Proceed as follows:

1. If the recipe view contains several recipes: Select the recipe which contains the desired recipe data record.
2. Select the recipe data record whose values you want to transfer to the PLC.
3. Press  + .

Result

The display values in the recipe view were transferred to the PLC and take effect in the process.

See also

Recipes in the project (Page 220)

10.7 Operating the simple recipe view

10.7.1 Overview

Introduction

The simple recipe view consists of three areas:

- Recipe list
- Record list
- Element list

You can use the context menu to operate each of these display areas.

Operation





The simple recipe view can be operated as follows:

- Enter values for the recipe elements
- Create recipe data records
- Save recipe data records or save them under a new name
- Delete recipe data records
- Transfer recipe data records from the PLC and to the PLC



Operating elements of the simple recipe view

Toggle between the display areas and the context menus to operate the simple recipe views.

The table below shows the operation of the display area.

| Touch operation | Key control | Functions |
|---|---|---|
| Touching an entry |  | The next lower display area opens. |
|  |  | The next higher display area opens. |
|  |  | The context menu of the display area opens. |

The table below shows the operation of the context menu.

| Touch operation | Key control | Functions |
|---|---|--|
|  |  | The menu is closed. The display area opens. |
| Touch the menu command | Input of the number of the menu command | The menu command is executed. |



Context menus of the simple recipe view

A number is assigned to each menu command which you can use to call the menu command with key control.

With touch operation, touch the menu command to execute it.

Some menu functions can also be called directly in the lists of the simple recipe view using the keys.

- Recipe list

| No. | Menu command | Key combination | Functions |
|-----|---------------------|---|--|
| 0 | New | | A new recipe data record is created for the selected recipe. If a start value is configured, it is shown in the text box. |
| 1 | Displaying infotext |  | The infotext configured for the simple recipe view is displayed. |
| 2 | Open |  | The record list of the selected recipe opens. |

- Record list

| No. | Menu command | Key combination | Functions |
|-----|--------------|---|--|
| 0 | New | | A new recipe data record is created for the selected recipe. If a start value is configured, it is shown in the text box. |
| 1 | Delete |  | The selected record is deleted. |
| 2 | Save as | | The selected record is saved under a different name irrespective of the simple recipe view. A dialog box opens in which the name is entered. |
| 3 | Rename | | The selected record is renamed. A dialog box opens in which the name is entered. |

- Element list

| No. | Menu command | Key combination | Functions |
|-----|--------------|-----------------|---|
| 0 | Save | | The selected record is renamed. |
| 1 | To PLC | | The display values of the selected record are transferred from the HMI device to the PLC. |
| 2 | From PLC | | The recipe values from the PLC are displayed on the HMI device in the recipe view. |
| 3 | Save as | | The selected record is renamed. A dialog box opens in which the name is entered. |

Touch operation of the menu

Touch the desired menu command. The command is executed.

Key control of the menu

Select the required entry using  or . Press .

Alternatively, press the numerical key with the number of the desired menu command.

The command is executed.

Operating the recipe screen

You operate the recipes in a recipe screen with the operating elements provided by the configuration engineer.

Further information on this may be available in your plant documentation

10.7.2 Creating a recipe data record

Introduction

Create a new recipe data record in the recipe list or in the record list. Then enter the values for the new record in the element list and save the record.

Requirements

A screen with a simple recipe view is displayed.

Procedure

Proceed as follows:

1. If the recipe list contains several recipes: Select the recipe for which you want to create a new recipe data record.
2. Open the recipe list menu.
3. Select the menu command "0 New".
Creates a new record
The element list of the new record opens.
4. Enter values for the elements of the data record.
The tags of the record can be assigned default values depending on the configuration.
5. Open the element list menu and select the menu command "0 Save".
6. Enter a name for the new record.
7. Confirm your entries.

If you change the new data record number to an existing data record number, the existing data record is overwritten.

Result

The new recipe data record is saved to the selected recipe.

See also

Recipes in the project (Page 220)

10.7.3 Editing a recipe data record

Introduction

Edit the values of the recipe data records in a simple recipe view.

Synchronization with the PLC

If you want to display the current recipe values from the PLC in the simple recipe view, you first have to read the current values from the PLC with the menu command "2 from PLC" in the element list.

The values changed in the recipe view only take effect in the PLC when you transfer the edited data record to the PLC with the menu command "1 to PLC".

Requirements

A screen with a simple recipe view is displayed.

Procedure

Proceed as follows:

1. If the recipe list contains several recipes: Select the recipe which contains the desired recipe data record.
2. Open the data record list.
3. Select the recipe data record you want to change.
4. Open the element list.
5. Change the values of the records as required.
6. Save your changes with the menu command "0 Save".

The recipe data record is saved.

Result

The edited recipe data record has now been saved in the selected recipe.

See also

Recipes in the project (Page 220)

10.7.4 Deleting a recipe data record

Introduction

You can delete all the data records which are not required.

Requirements

A screen with a simple recipe view is displayed.

Procedure using the touch screen

Proceed as follows:

1. If the recipe list contains several recipes: Select the recipe which contains the desired recipe data record.
2. Open the data record list.
3. Select the data record you want to delete.
4. Open the menu.
5. Select the menu command "1 Delete".

Procedure using the keys

Proceed as follows:

1. If the recipe list contains several recipes: Select the recipe which contains the desired recipe data record.
2. Open the data record list.
3. Select the data record you want to delete.
4. Press .

Result

The data record is deleted.

See also

Recipes in the project (Page 220)

10.7.5 Reading a recipe data record from the PLC

Introduction

The values of recipe elements are exchanged with the PLC via tags.

In the current project, the values which are also stored in the recipes in the HMI device can be changed directly in the plant. This is the case, for example, if a valve was opened further directly at the plant than is stored in the recipe. The values of the tags on the HMI device possibly no longer match the values in the PLC.

To synchronize the recipe values, read the values from the PLC and display them in the recipe view.

Requirements

A screen with a simple recipe view is displayed.

Procedure

Proceed as follows:

1. If the recipe list contains several recipes: Select the recipe which contains the desired recipe data record.
2. Select the element list of the recipe data record to which you want to apply the values from the PLC.
3. Open the menu.
4. Select the menu command "2 from PLC".
The values are read from the PLC.
5. If you want to save the display values in the HMI device, select the menu command "0 Save".

Result

The values were read from the PLC, displayed on the HMI device and saved to the selected recipe data record.

See also

Recipes in the project (Page 220)

10.7.6 Transferring a recipe data record to the PLC

Introduction

In order for an edited recipe data record to take effect in the process, you must transfer the values to the PLC.

The display values in the recipe view are always transferred to the PLC.

Requirements

A screen with a simple recipe view is displayed.

Procedure

Proceed as follows:

1. If the recipe list contains several recipes: Select the recipe which contains the desired recipe data record.
2. Select the element list of the recipe data record whose values you want to transfer to the PLC.
3. Open the menu.
4. Select the menu command "1 To PLC".

Result

The values of the recipe data record were transferred to the PLC and take effect in the process.

See also

Recipes in the project (Page 220)

10.8 Exporting a recipe data record

Introduction

You can export one or more recipe data records to a CSV file, depending on the configuration. After export, the values in the recipe data record can be further processed in a spreadsheet program such as MS Excel. The degree to which you can influence the export depends on the configuration:

Requirements

- A screen with a recipe view is displayed
- An operating element with the function "Export record" has been configured.
- The following tags are configured equally in the recipe view and for the "Export record" operating element.
 - Recipe number
 - Data record number

Procedure

Proceed as follows:

1. If the recipe view contains several recipes: Select the recipe which contains the desired recipe data record.
2. Select the recipe data record you want to export.
3. Operate the operating element which was configured for export, for example the "Export data record" button.

The data record is exported as a CSV file to an external data medium.

Further information on this may be available in your plant documentation

Result

The recipe data record is exported.

See also

Recipes in the project (Page 220)

10.9 Importing a recipe data record

Introduction

You can import values from a CSV file to a recipe data record, depending on the configuration.

Requirements

- An operating element with the function "Import data record" has been configured, for example a button
- A screen with a recipe view is displayed

Procedure

Proceed as follows:

1. If the recipe view contains several recipes: Select the recipe which contains the recipe data record to be imported.
2. Operate the operating element with the function "Import data record".

The record is imported from an external data medium as a CSV file and then displayed in the recipe view after import.

Result

The imported recipe data record is saved on the HMI device.

Deviating structure

If the structure of the CSV file differs from the structure of the recipe, deviations are handled as follows:

- Any additional values in the CSV file will be rejected
- The system applies the configured default value to the recipe data record if the CSV file contains an insufficient number of values
- If the CSV file contains values of the wrong data type, the configured default value is set in the recipe data record

Example:

The imported CSV file contains values that were entered as floating point numbers

However, the corresponding tag expects an integer value. In this case, the system discards the imported value and uses the configured default

See also

Recipes in the project (Page 220)

10.10 Examples

10.10.1 Entering a recipe data record

Introduction

You would like to enter production data on the HMI device without interrupting the process in the machine or plant. For this reason, the production data should not be transferred to the PLC.

Procedure

Proceed as follows:

1. Call the recipe view or a recipe screen.
2. Select the desired recipe data record.
3. Enter the values of the elements.
4. Save the recipe data record.

The recipe data record is saved in the internal memory of the HMI device.

The following figure shows the data flow schematically.

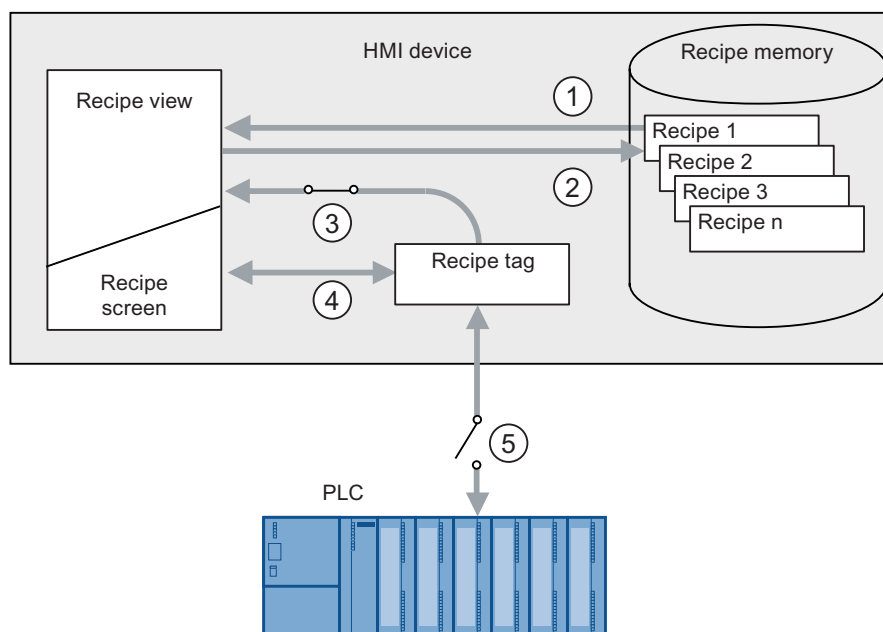

- ① Display recipe data record
- ② Save recipe data record
- ③ Tags are synchronized
- ④ Display and edit recipe tags in the recipe screen
- ⑤ Tags are offline

10.10.2 Manual production sequence

Introduction

You request the production data of different workpieces from the PLC and display this data on the screen of the HMI device for inspection. You want to correct the transferred production data in the recipe view or the recipe screen if necessary.

Procedure

A scanner connected to the PLC reads the barcode of a workpiece. The barcode names correspond to the names in the recipe data record. Based on the barcode name, the PLC can read the required recipe data record. The recipe data record is displayed for inspection on the HMI device. You can now edit and save the recipe data record. Then transfer the edited recipe data record to the PLC again.

The following figure shows the data flow schematically.

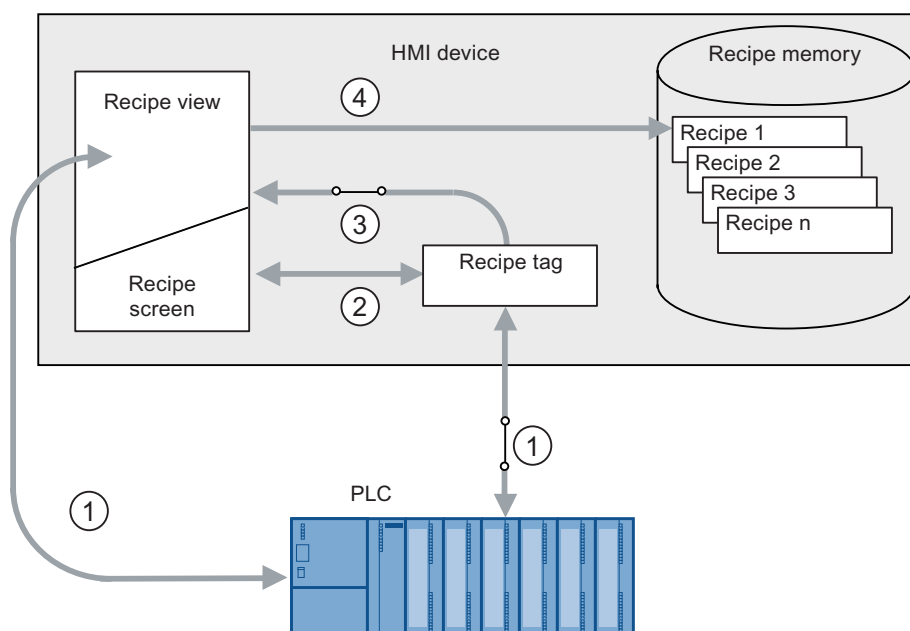

- ① The recipe data record is read from the PLC and written to the PLC again following changes
- ② Display and edit recipe tags in the recipe screen
- ③ Tags are synchronized
- ④ Recipe data records are saved in the recipe memory of the HMI device

Maintenance and care

11.1 Maintenance and care

Scope of maintenance

The HMI device is designed for maintenance-free operation. The touch screen and keyboard membrane should nevertheless be cleaned regularly.

Preparation

| |
|--|
|  CAUTION |
|--|

| |
|------------------------------|
| Inadvertent operation |
|------------------------------|

| |
|--|
| Always switch off the HMI device before cleaning it. This will ensure that you do not trigger functions unintentionally when you touch the keys. |
|--|

Requirements

Use a cleaning cloth dampened with a cleaning agent to clean the equipment. Only use water with a little liquid soap or a screen cleaning foam.

| |
|----------------|
| CAUTION |
|----------------|

| |
|---|
| Do not clean the HMI device with compressed air or steam jet blowers. Never use aggressive solvents or scouring powder. |
|---|

Procedure

Proceed as follows:

1. Switch off the HMI device.
2. Spray the cleaning solution onto a cleaning cloth.
Do not spray directly onto the HMI device.
3. Clean the HMI device.
When cleaning the display wipe from the screen edge inwards.

11.2 Clean screen on MP 277 Touch

Clean screen

The HMI touch screen can be cleaned when it is switched on and a project is running. An operating element must be available in the project with which the clean screen can be called. Once the clean screen is activated, touch screen operation is locked for a configured period of time. The time the touch screen is locked can be set between 5 and 30 seconds. The time remaining for the lockout is indicated by a progress bar.

 **WARNING**

Locking operating elements

Always open the clean screen or switch off the HMI device before you clean the touch screen while the system is running!

It is important to note when the clean screen function is unlocked. Ignoring this instruction may lead to inadvertent operation of a function.

11.3 Spare Parts and Repairs

Repairs

In case of repair, the HMI device must be shipped to the Return Center in Fürth. Repairs may only be carried out at the Return Center in Fürth.

Depending on the work necessary to repair the device, the Center may decide to give you a credit note. In this case, it is your responsibility to order a new device.

The address is:

Returns Center
Siemensstr. 2
90766 Fürth
Germany

Spare parts

You can find spare parts and accessories for the HMI devices in the section Accessories (Page 23).

Technical specifications

12.1 Dimension drawings

12.1.1 Dimension drawings of the MP 277 8" Touch

The HMI device MP 277 8" Touch is available in two enclosure models with different product versions. The product version is indicated on the back of the HMI device.

Dimensional drawing of MP 277 8" Touch up to and including product version 05

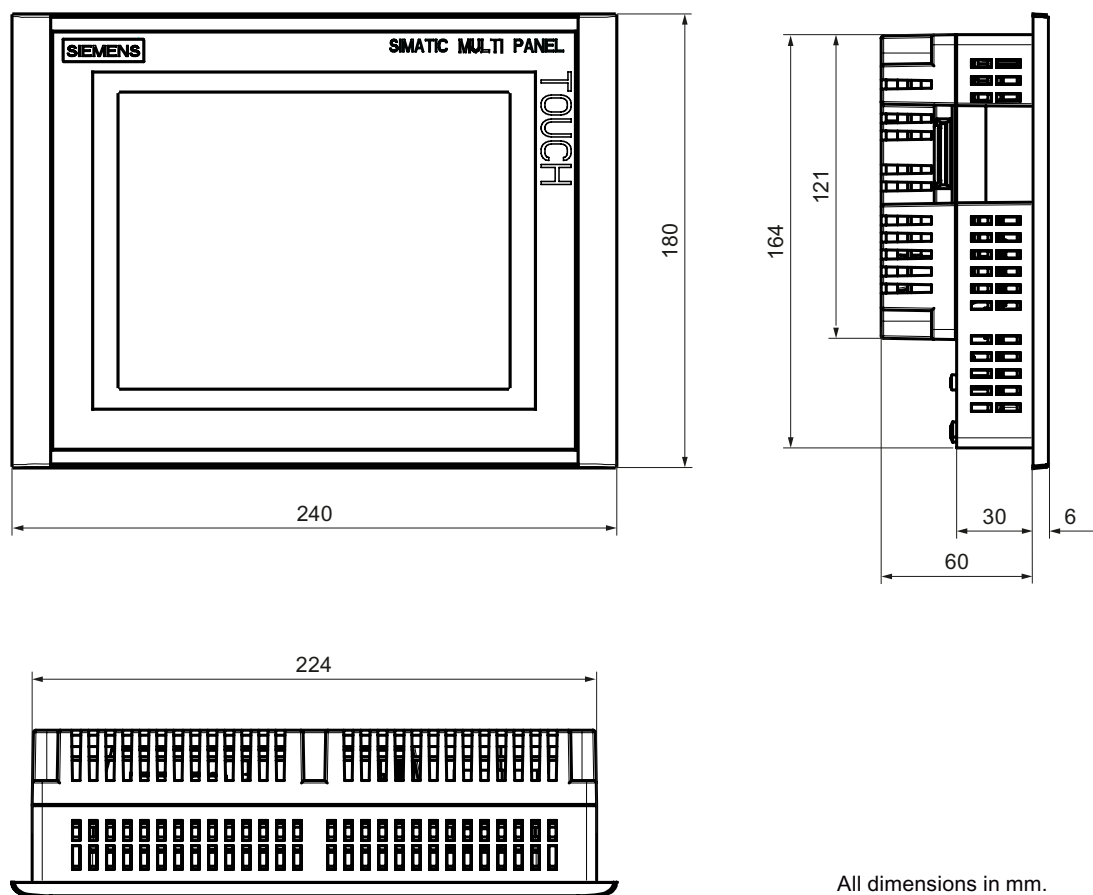

All dimensions in mm.

Dimensional drawing of MP 277 8" Touch as of product version 15

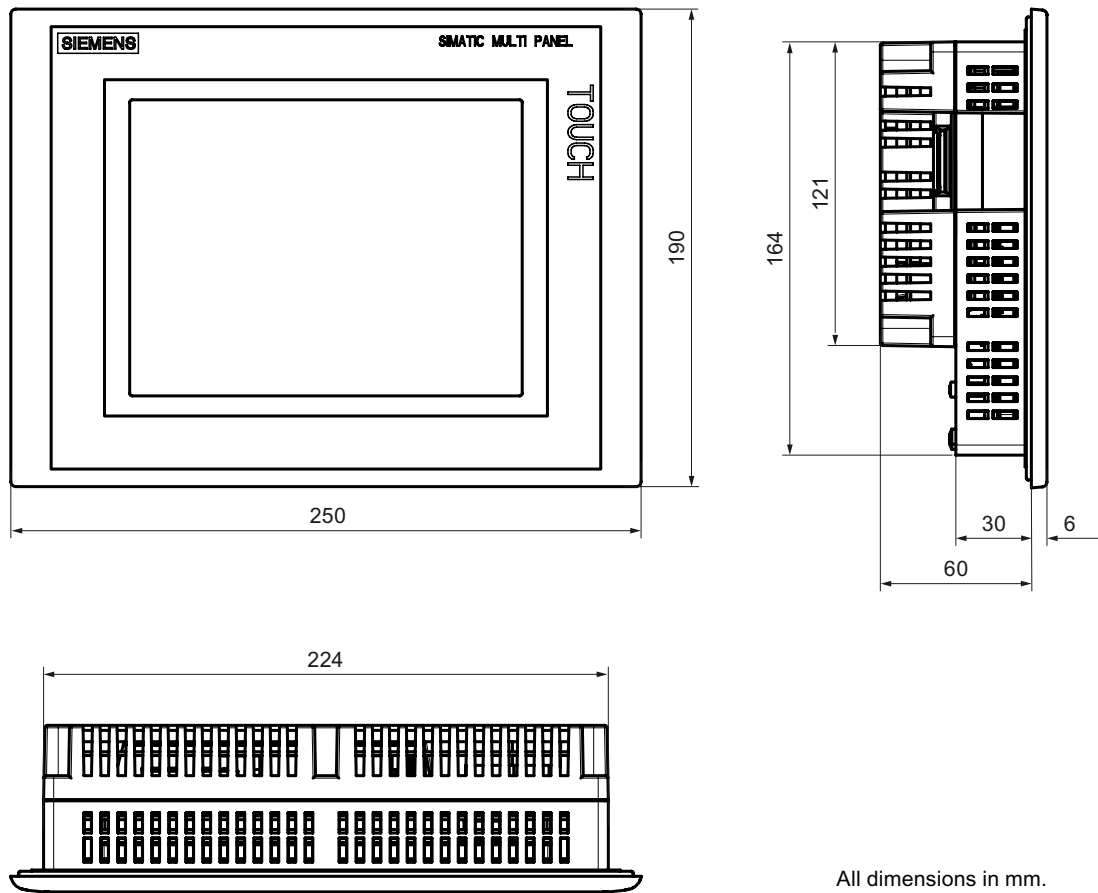

All dimensions in mm.

12.1.2 Dimension drawings of the MP 277 8" Key

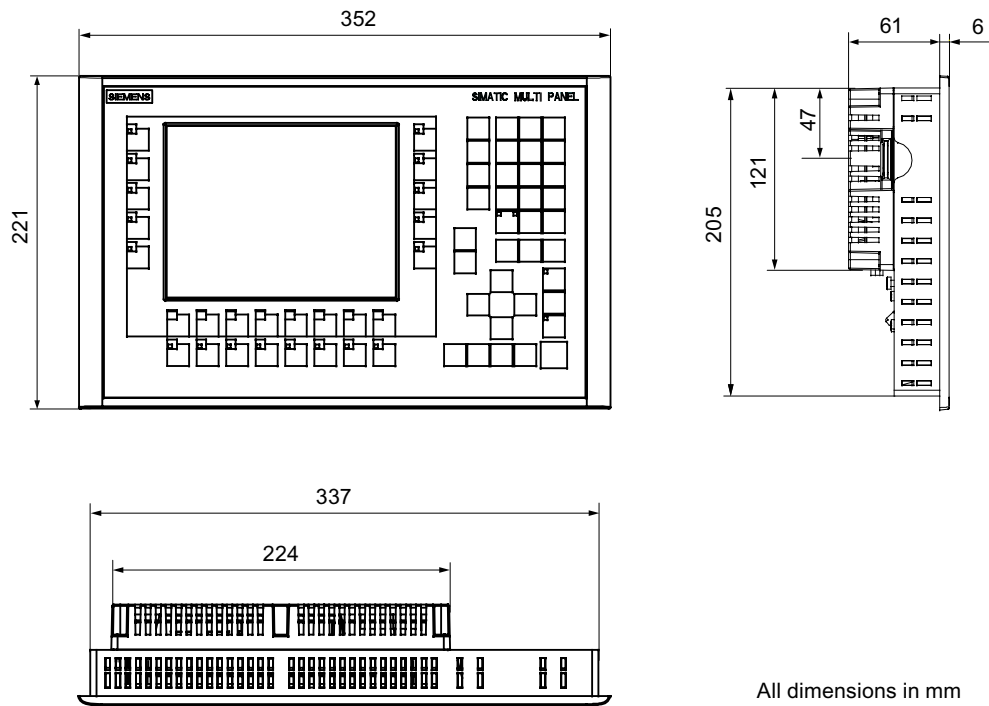

All dimensions in mm

12.1.3 Dimension Drawings of the MP 277 10" Touch

The HMI device MP 277 10" Touch is available in two enclosure models with different product versions. The product version is indicated on the back of the HMI device.

Dimension drawing of MP 277 10" Touch up to and including product version 06

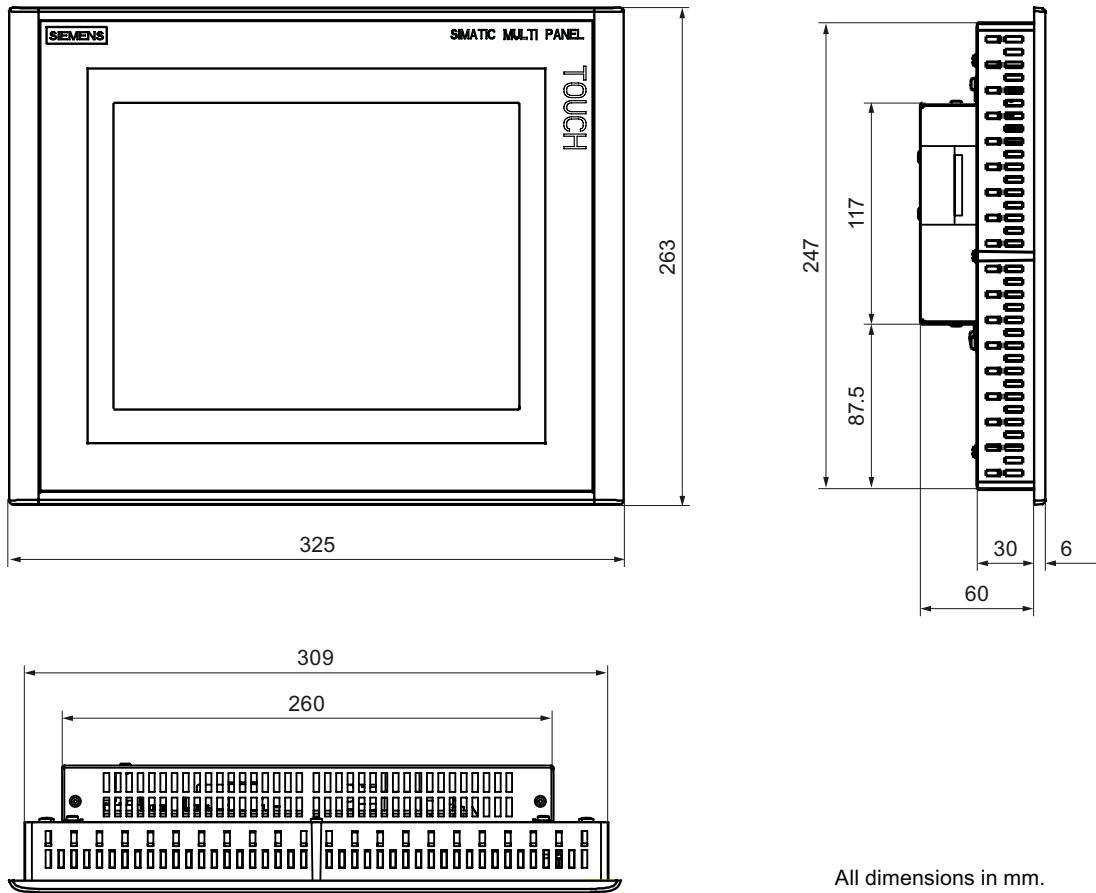

All dimensions in mm.

Dimensional drawing of MP 277 10" Touch as of product version 15

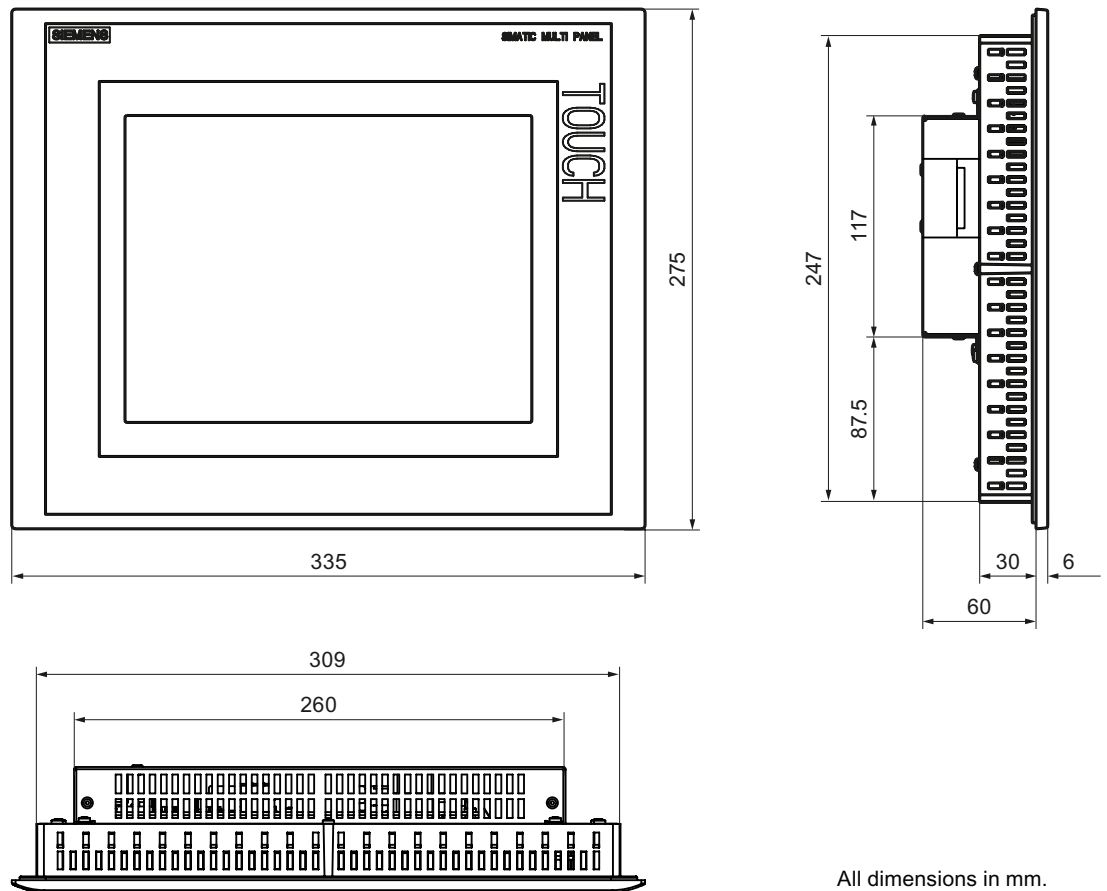

All dimensions in mm.

12.1.4 Dimension drawings of the MP 277 10" Key

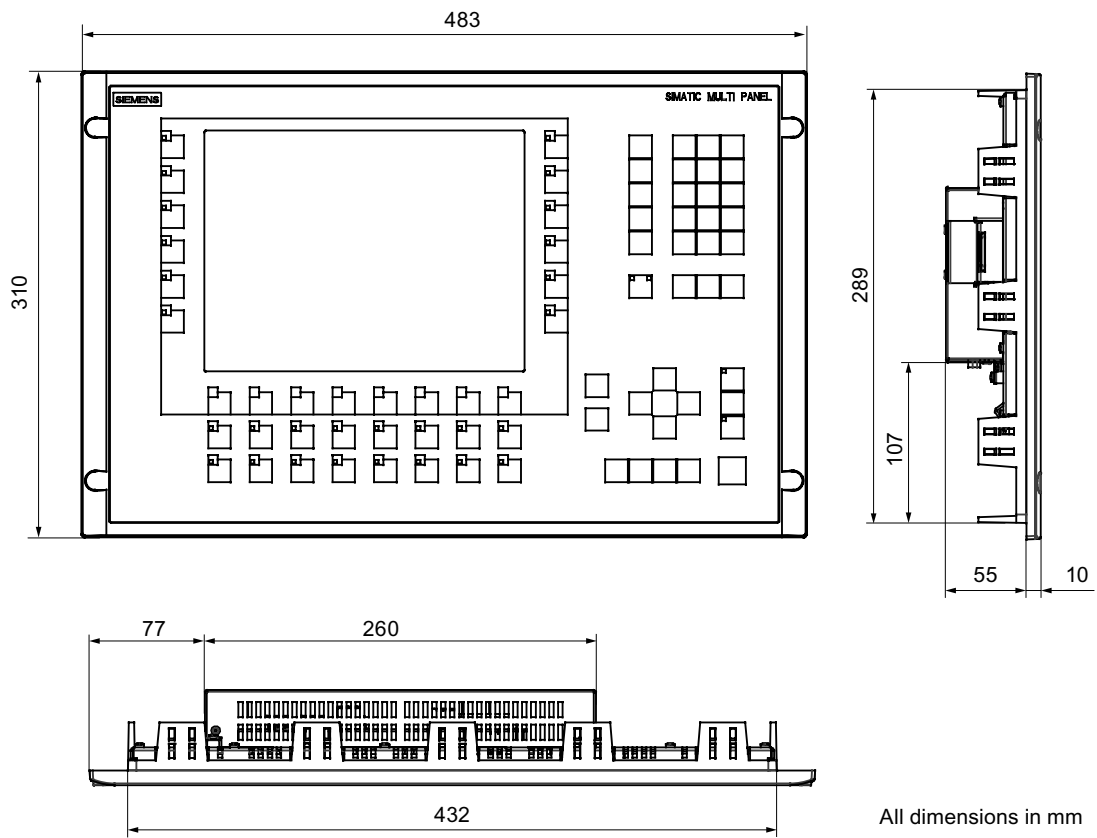

12.2 Specifications

12.2.1 Specifications of the MP 277 Touch

HMI device

| | MP 277 8" Touch | MP 277 10" Touch |
|--------------------------|-----------------|------------------|
| Weight without packaging | Approx. 1 610 g | Approx. 2 650 g |

Display

| | MP 277 8" Touch | MP 277 10" Touch |
|------------------------------------|----------------------------|-----------------------------|
| Display area, active | 153.7 mm x 115.8 mm (7.5") | 211.2 mm x 158.4 mm (10.4") |
| Type | LCD TFT | |
| Resolution | 640 x 480 pixels | |
| Colors, displayable | 64k | |
| Brightness control | Yes | |
| Backlighting | CCFL | |
| Half brightness life time, typical | 50 000 h | |

Input device

| | MP 277 8" Touch | MP 277 10" Touch |
|------|---------------------------------|------------------|
| Type | Touch screen, analog, resistive | |

Memory

| | MP 277 8" Touch | MP 277 10" Touch |
|--------------------|-----------------|------------------|
| Application memory | 6 MB | |

Ports

| | MP 277 8" Touch | MP 277 10" Touch |
|-------------------|--|------------------|
| 1 x RS 422/RS 485 | Max. 12 Mbps | |
| 2 x USB | USB host; conforms to USB standard 1.1 (supporting low-speed and full-speed USB devices) Maximum load 500 mA | |
| 1 x Ethernet | RJ45 10/100 Mbps | |

Supply voltage

| | MP 277 8" Touch | MP 277 10" Touch |
|---|--|--|
| Rated voltage | +24 V DC | |
| Range, permissible | 20.4 V to 28.8 V (-15%, +20%) | |
| Transients, maximum permissible | 35 V (500 ms) | |
| Time between two transients, minimum | 50 s | |
| Current consumption | | |
| <ul style="list-style-type: none"> • Typical • Constant current, maximum • Power on current surge I²t | <ul style="list-style-type: none"> • Approx. 600 mA • Approx. 1 000 mA • Approx. 1 A²s | <ul style="list-style-type: none"> • Approx. 700 mA • Approx. 1 100 mA • Approx. 1 A²s |
| Fuse, internal | Electronic | |

Miscellaneous

| | MP 277 8" Touch | MP 277 10" Touch |
|--|----------------------|------------------|
| Realtime clock, buffered ¹⁾ | Yes | |
| Magnetic field intensity | 50/60 Hz;100 A/m RMS | |

¹⁾ Bridging time of the buffering, approx. 6 weeks.

12.2.2 Specifications of the MP 277 Key

HMI device

| | MP 277 8" Key | MP 277 10" Key |
|--------------------------|-----------------|-----------------|
| Weight without packaging | Approx. 2 250 g | Approx. 4 950 g |

Display

| | MP 277 8" Key | MP 277 10" Key |
|------------------------------------|----------------------------|-----------------------------|
| Display area, active | 153.7 mm x 115.8 mm (7.5") | 211.2 mm x 158.4 mm (10.4") |
| Type | LCD TFT | |
| Resolution | 640 x 480 pixels | |
| Colors, displayable | 64k | |
| Brightness control | Yes | |
| Backlighting | CCFL | |
| Half brightness life time, typical | 50 000 h | |

Input device

| | MP 277 8" Key | MP 277 10" Key |
|---------------|---|---|
| Type | Membrane keyboard | |
| Function keys | 26 function keys, of which 18 with LED | 34 function keys, of which 26 with LED |

Memory

| | MP 277 8" Key | MP 277 10" Key |
|--------------------|---------------|----------------|
| Application memory | 6 MB | |

Ports

| | MP 277 8" Key | MP 277 10" Key |
|-------------------|--|----------------|
| 1 x RS 422/RS 485 | Max. 12 Mbps | |
| 2 x USB | USB host; conforms to USB standard 1.1 (supporting low-speed and full-speed USB devices) Maximum load 500 mA | |
| 1 x Ethernet | RJ45 10/100 Mbps | |

Supply voltage

| | MP 277 8" Key | MP 277 10" Key |
|---|--|--|
| Rated voltage | +24 V DC | |
| Range, permissible | 20,4 V to 28.8 V (-15 %, +20%) | |
| Transients, maximum permissible | 35 V (500 ms) | |
| Time between two transients, minimum | 50 s | |
| Current consumption | <ul style="list-style-type: none"> • Typical • Constant current, maximum • Power on current surge I^2t | <ul style="list-style-type: none"> • Approx. 800 mA • Approx. 1 200 mA • Approx. 1 A²s |
| Fuse, internal | Electronic | |

Miscellaneous

| | MP 277 8" Key | MP 277 10" Key |
|--|-----------------------|----------------|
| Realtime clock, buffered ¹⁾ | Yes | |
| Magnetic field intensity | 50/60 Hz; 100 A/m RMS | |

¹⁾ Bridging time of the buffering, approx. 6 weeks.

12.3 Bit assignment of the direct keys

The following figures show the assignment of the keys and LEDs to the bytes in the PLC process image.

Further information may be available in your plant documentation.

Note

Do not use the LED bits "ACK", "A-Z l", "A-Z r" and "HELP" when a project is running on the HMI device.

Bit assignment of the direct keys for the MP 277 8" Key

| Button bits | | | | | | | | Byte | LED bits | | | | | | | |
|-------------|-----|------|-------|-----|-----|-----|-----|-------|----------|-------|-------|------|----|----|-----|----|
| 7 | 6 | 5 | 4 | 3 | 2 | 1 | 0 | | 7 | 6 | 5 | 4 | 3 | 2 | 1 | 0 |
| F8 | F7 | F6 | F5 | F4 | F3 | F2 | F1 | n | F8 | F7 | F6 | F5 | F4 | F3 | F2 | F1 |
| F16 | F15 | F14 | F13 | F12 | F11 | F10 | F9 | n + 1 | | | | | | | F10 | F9 |
| K4 | K3 | K2 | K1 | | | F18 | F17 | n + 2 | K4 | K3 | K2 | K1 | | | | |
| | | | | K8 | K7 | K6 | K5 | n + 3 | | | | | K8 | K7 | K6 | K5 |
| ACK | ALT | CTRL | SHIFT | | | | | n + 4 | ACK | A-Z l | A-Z r | HELP | | | | |

Bit assignment of the direct keys for the MP 277 10" Key

| Button bits | | | | | | | | Byte | LED bits | | | | | | | |
|-------------|-----|------|-------|-----|-----|-----|-----|-------|----------|-------|-------|------|-----|-----|-----|-----|
| 7 | 6 | 5 | 4 | 3 | 2 | 1 | 0 | | 7 | 6 | 5 | 4 | 3 | 2 | 1 | 0 |
| F8 | F7 | F6 | F5 | F4 | F3 | F2 | F1 | n | F8 | F7 | F6 | F5 | F4 | F3 | F2 | F1 |
| F16 | F15 | F14 | F13 | F12 | F11 | F10 | F9 | n + 1 | | | | | F12 | F11 | F10 | F9 |
| K4 | K3 | K2 | K1 | F20 | F19 | F18 | F17 | n + 2 | K4 | K3 | K2 | K1 | | | | |
| K12 | K11 | K10 | K9 | K8 | K7 | K6 | K5 | n + 3 | K12 | K11 | K10 | K9 | K8 | K7 | K6 | K5 |
| ACK | ALT | CTRL | SHIFT | K16 | K15 | K14 | K13 | n + 4 | ACK | A-Z l | A-Z r | HELP | K16 | K15 | K14 | K13 |

Bit assignment of the direct keys for the MP 277 8" Touch

| Touch assignment | | | | | | | | Byte |
|------------------|----|----|----|----|----|----|----|-------|
| 7 | 6 | 5 | 4 | 3 | 2 | 1 | 0 | |
| 7 | 6 | 5 | 4 | 3 | 2 | 1 | 0 | n |
| 15 | 14 | 13 | 12 | 11 | 10 | 9 | 8 | n + 1 |
| 23 | 22 | 21 | 20 | 19 | 18 | 17 | 16 | n + 2 |
| 31 | 30 | 29 | 28 | 27 | 26 | 25 | 24 | n + 3 |
| 39 | 38 | 37 | 36 | 35 | 34 | 33 | 32 | n + 4 |

Bit assignment of the direct keys for the MP 277 10" Touch

| Touch assignment | | | | | | | | Byte |
|------------------|----|----|----|----|----|----|----|-------|
| 7 | 6 | 5 | 4 | 3 | 2 | 1 | 0 | |
| 7 | 6 | 5 | 4 | 3 | 2 | 1 | 0 | n |
| 15 | 14 | 13 | 12 | 11 | 10 | 9 | 8 | n + 1 |
| 23 | 22 | 21 | 20 | 19 | 18 | 17 | 16 | n + 2 |
| 31 | 30 | 29 | 28 | 27 | 26 | 25 | 24 | n + 3 |
| 39 | 38 | 37 | 36 | 35 | 34 | 33 | 32 | n + 4 |

See also

Direct keys (Page 164)

12.4 Description of the ports

12.4.1 Power supply

Plug connector, 2-pin



| Pin | Assignment |
|-----|--------------|
| 1 | +24 VDC (L+) |
| 2 | GND 24 V (M) |

12.4.2 X10/IF 1B (RS 422/RS 485)

Sub-D socket, 9-pin, with screw lock

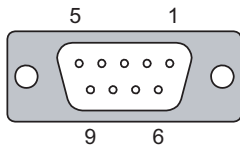

| Pin | Assignment for the RS 422 | Assignment for the RS 485 |
|-----|----------------------------|----------------------------|
| 1 | n. c. | n. c. |
| 2 | GND 24 V | GND 24 V |
| 3 | TxD+ | Data channel B (+) |
| 4 | RD+ | RTS ¹⁾ |
| 5 | GND 5 V, floating | GND 5 V, floating |
| 6 | +5 VDC, floating | +5 VDC, floating |
| 7 | +24 VDC, out (max. 100 mA) | +24 VDC, out (max. 100 mA) |
| 8 | TxD- | Data channel A (-) |
| 9 | RxD- | RTS ¹⁾ |

¹⁾ On pin 4 or pin 9, can be set with DIP switch on the rear of the device

12.4.3 X20, X21 (USB)

USB socket

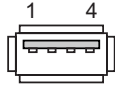

| Pin | Assignment |
|-----|---------------------------|
| 1 | +5 VDC, out (max. 500 mA) |
| 2 | USB-DN |
| 3 | USB-DP |
| 4 | GND |

12.4.4 X1 (Ethernet/LAN)

RJ45 plug connector

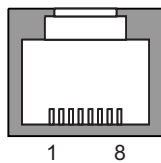

| Pin | Assignment |
|-----|------------|
| 1 | Tx+ |
| 2 | Tx- |
| 3 | Rx+ |
| 4 | n. c. |
| 5 | n. c. |
| 6 | Rx- |
| 7 | n. c. |
| 8 | n. c. |

Appendix

A.1 ESD guideline

What does ESD mean?



All electronic modules are equipped with large-scale integrated ICs or components. Due to their design, these electronic components are highly sensitive to overvoltage and thus to the discharge of static electricity. Such electronic components are labeled as Electrostatic Sensitive Device.

Short description

The following abbreviations are commonly used for electrostatic sensitive devices:

- EGB – Elektrostatisch Gefährdete Bauteile/Baugruppen (Germany)
- ESD – Electrostatic Sensitive Device (internationally recognized term)

Electrostatic charge

CAUTION**Electrostatic charge**

ESDs may be destroyed by voltages far below the level perceived by human beings. Voltages of this kind develop when a component or an assembly is touched by a person who is not grounded against static electricity. Usually, it is unlikely that damage to an ESD as a result of overvoltage is detected immediately but may become apparent only after a longer period of operation.

Avoid electrostatic charge to your body before you touch the ESD.

Anyone who is not connected to the electrical potential of their surroundings is subject to electrostatic charge.

The following figure indicates the maximum electrostatic charge anyone is subjected to when coming into contact with the materials shown. These values correspond to IEC 801-2 specifications.

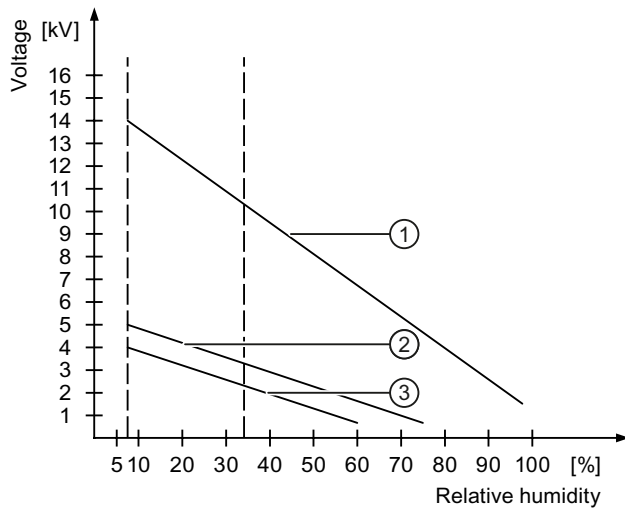

- ① Synthetic materials
- ② Wool
- ③ Antistatic materials such as wood or concrete

Protective measures against discharge of static electricity

CAUTION

Grounding measures

No equipotential bonding is possible without ground. Electrostatic charges will not be discharged and may damage the ESD.

When working with electrostatic sensitive devices, make sure that the person, the workplace and the packaging are properly grounded.

As a rule, only touch the ESD if this is unavoidable. This may be the case for maintenance. When you touch ESD modules, avoid touching the pins or the PCB tracks. This measure prevents discharged energy from reaching and damaging components sensitive to voltage.

Discharge electrostatic electricity from your body if you are performing measurements on an ESD. Do so by touching grounded metallic parts.

Always use grounded measuring instruments.

A.2 System alarms

Introduction

System alarms on the HMI device provide information about internal states of the HMI device and PLC.

The following overview shows the causes of system alarms and how to eliminate the cause of error.

Depending on scope of functions, only some of the system alarms described in this section apply to the various HMI devices.

Note

System alarms are only indicated if an alarm window was configured. System alarms are output in the language currently set on your HMI device.

System alarm parameters

System alarms may contain encrypted parameters which are relevant to troubleshooting because they provide a reference to the source code of the runtime software. These parameters are output after the text "Error code:"

Meaning of the system alarms

| Number | Effect/cause | Remedy |
|--------|--|--|
| 10000 | The print job could not be started or was canceled due to an unknown error. Faulty printer setup. Or: No authorization is available for accessing the network printer. Power supply failure during data transfer. | Check the printer settings, cable connections and the power supply. Set up the printer once again. Obtain a network printer authorization. If the error persists, contact the Hotline! |
| 10001 | No printer is installed or a default printer has not been set up. | Install a printer and/or select it as the default printer. |
| 10002 | Overflow of the graphics buffer for printing. Up to two images are buffered. | Allow sufficient intervals between successive print jobs. |
| 10003 | Images can now be buffered again. | — |
| 10004 | Overflow of the buffer for printing lines in text mode (e.g. alarms). Up to 1000 lines are buffered. | Allow sufficient intervals between successive print jobs. |
| 10005 | Text lines can now be buffered again. | — |
| 10006 | The Windows printing system reports an error. Refer to the output text and the error ID to determine the possible causes. Nothing is printed or the print is faulty. | Repeat the action if necessary. |
| 20010 | An error has occurred in the specified script line. Execution of the script was therefore aborted. Note the system alarm that may have occurred prior to this. | Select the specified script line in the configuration. Ensure that the tags used are of the allowed types. Check system functions for the correct number and types of parameters. |

| Number | Effect/cause | Remedy |
|--------|--|---|
| 20011 | An error has occurred in a script that was called by the specified script. Execution of the script was therefore aborted in the called script. Note the system alarm that may have occurred prior to this. | In the configuration, select the script that has been called directly or indirectly by the specified script. Ensure that the tags used are of the allowed types. Check system functions for the correct number and types of parameters. |
| 20012 | The configuration data is inconsistent. The script could therefore not be generated. | Recompile the configuration. |
| 20013 | The scripting component of WinCC flexible Runtime is not correctly installed. Therefore, no scripts can be executed. | Reinstall WinCC flexible Runtime. |
| 20014 | The system function returns a value that is not written in any return tag. | Select the specified script in the configuration. Check whether the script name has been assigned a value. |
| 20015 | Too many successive scripts have been triggered in short intervals. When more than 20 scripts are queued for processing, any subsequent scripts are rejected. In this case, the script indicated in the alarm is not executed. | Find what is triggering the scripts. Extend the times, e.g. the polling time of the tags which trigger the scripts. |
| 30010 | The tag could not accept the function result, e.g. when it has exceeded the value range. | Check the tag type of the system function parameter. |
| 30011 | A system function could not be executed because the function was assigned an invalid value or type in the parameter. | Check the parameter value and tag type of the invalid parameter. If a tag is used as a parameter, check its value. |
| 40010 | The system function could not be executed since the parameters could not be converted to a common tag type. | Check the parameter types in the configuration. |
| 40011 | The system function could not be executed since the parameters could not be converted to a common tag type. | Check the parameter types in the configuration. |
| 50000 | The HMI device is receiving data faster than it is capable of processing. Therefore, no further data is accepted until all current data have been processed. Data exchange then resumes. | — |
| 50001 | Data exchange has been resumed. | — |
| 60000 | This alarm is generated by the "DisplaySystemAlarms" function. The text to be displayed is transferred to the function as a parameter. | — |
| 60010 | The file could not be copied in the direction defined because one of the two files is currently open or the source/target path is not available. It is possible that the Windows user has no access rights to one of the two files. | Restart the system function or check the paths of the source/target files. Using Windows NT/2000/XP: The user executing WinCC flexible Runtime must be granted access rights for the files. |
| 60011 | An attempt was made to copy a file to itself. It is possible that the Windows user has no access rights to one of the two files. | Check the path of the source/target file. Using Windows NT/2000/XP with NTFS: The user executing WinCC flexible Runtime must be granted access rights for the files. |
| 70010 | The application could not be started because it could not be found in the path specified or there is insufficient memory space. | Check whether the application exists in the specified path or close other applications. |

| Number | Effect/cause | Remedy |
|--------|---|--|
| 70011 | The system time could not be modified. The error alarm only appears in connection with area pointer "Date/time PLC". Possible causes: <ul style="list-style-type: none"> • An invalid time was transferred in the job mailbox. • The Windows user has no right to modify the system time. If the first parameter in the system alarm is displayed with the value 13, the second parameter indicates the byte containing the incorrect value. | Check the time which is to be set. Using Windows NT/2000/XP: The user executing WinCC flexible Runtime must be granted the right to change the system time of the operating system. |
| 70012 | An error occurred when executing the function "StopRuntime" with the option "Runtime and operating system". Windows and WinCC flexible Runtime are not closed. One possible cause is that other programs cannot be closed. | Close all programs currently running. Then close Windows. |
| 70013 | The system time could not be modified because an invalid value was entered. Incorrect separators may have been used. | Check the time which is to be set. |
| 70014 | The system time could not be modified. Possible causes: <ul style="list-style-type: none"> • An invalid time was transferred. • The Windows user has no right to modify the system time. • Windows rejects the setting request. | Check the time which is to be set. Using Windows NT/2000/XP: The user executing WinCC flexible Runtime must be granted the right to change the system time of the operating system. |
| 70015 | The system time could not be read because Windows rejects the reading function. | — |
| 70016 | An attempt was made to select a screen by means of a system function or job. This is not possible because the screen number specified does not exist. Or: A screen could not be generated due to insufficient system memory. | Check the screen number in the function or job with the screen numbers configured. Assign the number to a screen if necessary. |
| 70017 | Date/time is not read from the area pointer because the address set in the PLC is either not available or has not been set up. | Change the address or set up the address in the PLC. |
| 70018 | Acknowledgment that the password list has been successfully imported. | — |
| 70019 | Acknowledgment that the password list has been successfully exported. | — |
| 70020 | Acknowledgment for activation of alarm reporting. | — |
| 70021 | Acknowledgment for deactivation of alarm reporting. | — |
| 70022 | Acknowledgment to starting the Import Password List action. | — |
| 70023 | Acknowledgment to starting the Export Password List action. | — |
| 70024 | The value range of the tag has been exceeded in the system function. The calculation of the system function is not performed. | Check the desired calculation and correct it if necessary. |

| Number | Effect/cause | Remedy |
|--------|--|--|
| 70025 | The value range of the tag has been exceeded in the system function. The calculation of the system function is not performed. | Check the desired calculation and correct it if necessary. |
| 70026 | No other screens are stored in the internal screen memory. No other screens can be selected. | — |
| 70027 | The backup of the RAM file system has been started. | — |
| 70028 | The files from the RAM have been copied in the Flash memory. The files from the RAM have been copied in the Flash memory. Following a restart, these saved files are copied back to the RAM file system. | — |
| 70029 | Backup of the RAM file system has failed. No backup copy of the RAM file system has been made. | Check the settings in the "Control Panel > OP" dialog and save the RAM file system using the "Save Files" button in the "Persistent Storage" tab. |
| 70030 | The parameters configured for the system function are faulty. The connection to the new PLC was not established. | Compare the parameters configured for the system function with the parameters configured for the PLCs and correct them as necessary. |
| 70031 | The PLC configured in the system function is not an S7 PLC. The connection to the new PLC was not established. | Compare the S7 PLC name parameter configured for the system function with the parameters configured for the PLC and correct them as necessary. |
| 70032 | The object configured with this number in the tab order is not available in the selected screen. The screen changes but the focus is set to the first object. | Check the number of the tab order and correct it if necessary. |
| 70033 | An e-mail cannot be sent because a TCP/IP connection to the SMTP server no longer exists. This system alarm is generated only at the first attempt. All subsequent unsuccessful attempts to send an e-mail will no longer generate a system alarm. The event is regenerated when an e-mail has been successfully sent in the meantime. The central e-mail component in WinCC flexible Runtime attempts, in regular intervals (1 minute), to establish the connection to the SMTP server and to send the remaining e-mails. | Check the network connection to the SMTP server and re-establish it if necessary. |
| 70034 | Following a disruption, the TCP/IP connection to the SMTP server could be re-established. The queued e-mails are then sent. | — |
| 70036 | No SMTP server for sending e-mails is configured. An attempt to connect to an SMTP server has failed and it is not possible to send e-mails. WinCC flexible Runtime generates the system alarm after the first attempt to send an e-mail. | Configure an SMTP server: In WinCC flexible Engineering System using "Device settings > Device settings" In the Windows CE operating system using "Control Panel > Internet Settings > E-mail > SMTP Server" |
| 70037 | An e-mail cannot be sent for unknown reasons. The contents of the e-mail are lost. | Check the e-mail parameters (recipient etc.). |

| Number | Effect/cause | Remedy |
|--------|---|---|
| 70038 | The SMTP server has rejected sending or forwarding an e-mail because the domain of the recipient is unknown to the server or because the SMTP server requires authentication. The contents of the e-mail are lost. | Check the domain of the recipient address or deactivate the authentication on the SMTP server if possible. SMTP authentication is currently not used in WinCC flexible Runtime. |
| 70039 | The syntax of the e-mail address is incorrect or contains illegal characters. The contents of the e-mail are discarded. | Check the e-mail address of the recipient. |
| 70040 | The syntax of the e-mail address is incorrect or contains illegal characters. | — |
| 70041 | The import of the user management was aborted due to an error. Nothing was imported. | Check your user management or transfer it again to the panel. |
| 80001 | The log specified is filled to the size defined (in percent) and must be stored elsewhere. | Store the file or table by executing a 'move' or 'copy' function. |
| 80002 | A line is missing in the specified log. | — |
| 80003 | The copying process for logging was not successful. In this case, it is advisable to check any subsequent system alarms, too. | — |
| 80006 | Since logging is not possible, this causes a permanent loss of the functionality. | In the case of databases, check whether the corresponding data source exists and start up the system again. |
| 80009 | A copying action has been completed successfully. | — |
| 80010 | Since the storage location was incorrectly entered in WinCC flexible, this causes a permanent loss of the functionality. | Configure the storage location for the respective log again and restart the system when the full functionality is required. |
| 80012 | Log entries are stored in a buffer. If the values are read to the buffer faster than they can be physically written (using a hard disk, for example), overloading may occur and recording is then stopped. | Archive fewer values. Or: Increase the logging cycle. |
| 80013 | The overload status no longer applies. Archiving resumes the recording of all values. | — |
| 80014 | The same action was triggered twice in quick succession. Since the process is already in operation, the action is only carried out once. | — |
| 80015 | This system alarm is used to report DOS or database errors to the user. | — |
| 80016 | The logs are separated by the system function "CloseAllLogs" and the incoming entries exceed the defined buffer size. All entries in the buffer are deleted. | Reconnect the logs. |
| 80017 | The number of incoming events cause a buffer overflow. This can be caused, for example, by several copying actions being activated at the same time. All copy jobs are deleted. | Stop the copy action. |

| Number | Effect/cause | Remedy |
|--------|--|--|
| 80019 | The connection between WinCC flexible and all logs were closed, for example, after executing the system function "CloseAllLogs". Entries are written to the buffer and are then written to the logs when a connection is re-established. There is no connection to the storage location and the storage medium may be replaced, for example. | — |
| 80020 | The maximum number of simultaneously copy operations has been exceeded. Copying is not executed. | Wait until the current copying actions have been completed, then restart the last copy action. |
| 80021 | An attempt was made to delete a log which is still busy with a copy action. Deletion has not been executed. | Wait until the current copying actions have been completed, then restart the last action |
| 80022 | An attempt was made to start a sequence log, which is not a sequence log, from a log using the system function "StartSequenceLog". No sequence log file is created. | In the project, check <ul style="list-style-type: none"> • if the "StartSequenceLog" system function was properly configured • if the tag parameters are properly provided with data on the HMI device |
| 80023 | An attempt was made to copy a log to itself. The log is not copied. | In the project, check <ul style="list-style-type: none"> • if the "CopyLog" system function was properly configured • if the tag parameters are properly provided with data on the HMI device |
| 80024 | The "CopyLog" system function does not allow copying when the target log already contains data ("Mode" parameter). The log is not copied. | Edit the "CopyLog" system function in the project if necessary. Before you initiate the system function, delete the destination log file. |
| 80025 | You have canceled the copy operation. Data written up to this point are retained. The destination log file (if configured) is not deleted. The cancellation is reported by an error entry \$RT_ERR\$ at the end of the destination log. | — |
| 80026 | This alarm is output after all logs are initialized. Values are written to the logs from then on. Prior to this, no entries are written to the logs, irrespective whether WinCC flexible Runtime is active or not. | — |
| 80027 | The internal Flash memory has been specified as the storage location for a log. This is not permissible. No values are written to this log and the log file is not created. | Configure "Storage Card" or a network path as the storage location. |
| 80028 | The alarm returns a status report indicating that the logs are currently being initialized. No values are logged until the alarm 80026 is output. | — |
| 80029 | The number of logs specified in the alarm could not be initialized. The logs are initialized. The faulty log files are not available for logging jobs. | Evaluate the additional system alarms , related to this alarm which is also generated. Check the configuration, the ODBC (Open Database Connectivity) and the specified drive. |
| 80030 | The structure of the existing log file does not match the expected structure. Logging is stopped for this log. | Delete the existing log data manually, in advance. |
| 80031 | The log in CSV format is corrupted. The log cannot be used. | Delete the faulty file. |

| Number | Effect/cause | Remedy |
|--------|---|--|
| 80032 | Logs can be assigned events. These are triggered as soon as the log is full. If WinCC flexible Runtime is started and the log is already full, the event is not triggered. The log specified no longer logs data because it is full. | Close WinCC flexible Runtime, delete the log, then restart WinCC flexible Runtime. Or: Configure a button which contains the same actions as the event and press it. |
| 80033 | "System Defined" is set in the data log file as the data source name. This causes an error. No data is written to the database logs, whereas the logging to the CSV logs works. | Install MSDE again. |
| 80034 | An error has occurred in the initialization of the logs. An attempt has been made to create the tables as a backup. This action was successful. A backup has been made of the tables of the corrupted log file and the cleared log was restarted. | No action is necessary. However, it is recommended to save the backup files or delete them in order to make the space available again. |
| 80035 | An error has occurred in the initialization of the logs. An attempt has been made to create backups of the tables and this has failed. No logging or backup has been performed. | It is recommended to save the backups or to delete them in order to release memory. |
| 80044 | The export of a log was interrupted because Runtime was closed or due to a power failure. When Runtime restarted, it was detected that the export needed to be resumed. | The export resumes automatically. |
| 80045 | The export of a log was interrupted due to an error in the connection to the server or at the server itself. | The export is repeated automatically. Check: <ul style="list-style-type: none"> • The connection to the server • If the server is running • If there is enough free space on the server |
| 80046 | The destination file could not be written while exporting the log. | Check whether there is enough space on the server and if you have permission to create the log file. |
| 80047 | The log could not be read while exporting it. | Check whether the storage medium is correctly inserted. |
| 80048 | — | — |
| 80049 | The log could not be renamed while preparing to export it. The job can not be completed." | Check whether the storage medium is correctly inserted and if there is sufficient space on the medium. |
| 80050 | The log which shall be exported is not closed. The job can not be completed. | Make sure the "CloseAll Logs" system function is called before using the "ExportLog" system function. Change the configuration as required. |
| 90024 | No operator actions can be logged due to lack of space on the storage medium for log. The operator action will therefore not be executed. | Make more space available by inserting an empty storage medium or swapping out the log files on the server using "ExportLog". |
| 90025 | No user actions can be logged because of error state of the archive. Therefore the user action will not be executed. | Check whether the storage medium is correctly inserted. |
| 90026 | No operator actions can be logged because the log is closed. The operator action will therefore not be executed. | Before further operator actions are carried out, the log must be opened again using the system function "OpenAllLogs". Change the configuration as required. |
| 90029 | Runtime was closed during ongoing operation (perhaps due to a power failure) or a storage medium in use is incompatible with Audit Trail. An Audit Trail is not suitable if it belongs to another project or has already been archived. | Ensure that you are using the correct storage medium. |

| Number | Effect/cause | Remedy |
|--------|--|---|
| 90030 | Runtime was closed during ongoing operation (perhaps due to a power failure). | — |
| 90031 | Runtime was closed during ongoing operation (perhaps due to a power failure). | — |
| 90032 | Running out of space on the storage medium for log. | Make more space available by inserting an empty storage medium or swapping out the log files on the server using "ExportLog". |
| 90033 | No more space on the storage medium for log. As of now, no more operator actions requiring logging will be executed. | Make more space available by inserting an empty storage medium or swapping out the log files on the server using "ExportLog". |
| 90040 | Audit Trail is switched off because of a forced user action. | Activate the "Audit Trail" again using the system function "StartLog". |
| 90041 | A user action which has to be logged has been executed without a logged on user. | A user action requiring logging should only be possible with permission. Change the configuration by setting a required authorization for the input object. |
| 90044 | A user action which has to be confirmed was blocked, because there is another user action pending. | Repeat the user action if necessary. |
| 110000 | The operating mode was changed. "Offline" mode is now set. | — |
| 110001 | The operating mode was changed. "Online" mode is now set. | — |
| 110002 | The operating mode was not changed. | Check the connection to the PLCs. Check whether the address area for the area pointer 88 "Coordination" in the PLC is available. |
| 110003 | The operating mode of the specified PLC was changed by the system function "SetConnectionMode". The operating mode is now "offline". | — |
| 110004 | The operating mode of the specified PLC has been changed by the system function "SetConnectionMode". The operating mode is now "online". | — |
| 110005 | An attempt was made to use the system function SetConnectionMode to switch the specified PLC to "online" mode, although the entire system is in "offline" mode. This changeover is not allowed. The PLC remains in "offline" mode. | Switch the complete system to "online" mode, then execute the system function again. |
| 110006 | The content of the "project version" area pointer does not match the user version configured in WinCC flexible. WinCC flexible Runtime is therefore closed. | Check: <ul style="list-style-type: none"> • The project version entered on the PLC • The project version entered in WinCC flexible |
| 120000 | The trend is not displayed because you configured an incorrect axis to the trend or an incorrect trend. | Change the configuration. |
| 120001 | The trend is not displayed because you configured an incorrect axis to the trend or an incorrect trend. | Change the configuration. |
| 120002 | The trend is not displayed because the tag assigned attempts to access an invalid PLC address. | Check whether the data area for the tag exists in the PLC, the configured address is correct and the value range for the tag is correct. |
| 130000 | The action was not executed. | Close all other programs. Delete files no longer required from the hard disk. |
| 130001 | The action was not executed. | Delete files no longer required from the hard disk. |

| Number | Effect/cause | Remedy |
|--------|---|--|
| 130002 | The action was not executed. | Close all other programs. Delete files no longer required from the hard disk. |
| 130003 | No data medium found. The operation is canceled. | Check, for example, if <ul style="list-style-type: none"> • The correct data medium is being accessed • The data medium is inserted |
| 130004 | The data medium is write-protected. The operation is canceled. | Check whether access has been made to the correct data carrier. Remove the write protection. |
| 130005 | The file is read only. The operation is canceled. | Check whether access has been made to the correct file. Edit the file attributes if necessary. |
| 130006 | Access to file failed. The operation is canceled. | Check, for example, if <ul style="list-style-type: none"> • The correct file is being accessed • The file exists • Another action is preventing simultaneous access to the file |
| 130007 | The network connection is interrupted. Records cannot be saved or read over the network connection. | Check the network connection and eliminate the cause of error. |
| 130008 | The storage card is not available. Records cannot be saved to / read from the storage card. | Insert the storage card. |
| 130009 | The specified folder does not exist on the storage card. Any files saved to this directory are not backed up when you switch off the HMI device. | Insert the storage card. |
| 130010 | The maximum nesting depth can be exhausted when, for example, a value change in a script results in the call of another script and the second script in turn has a value change that results in the call of yet a further script etc. The configured functionality is not supported. | Check the configuration. |
| 140000 | An online connection to the PLC is established. | — |
| 140001 | The online connection to the PLC was shut down. | — |
| 140003 | No tag updating or writing is executed. | Check the connection and if the PLC is switched on. Check the parameter definitions in the Control Panel using "Set PG/PC interface". Restart the system. |
| 140004 | No tag update or write operations are executed because the access point or the module configuration is faulty. | Verify the connection and check whether the PLC is switched on. Check the access point or the module configuration (MPI, PPI, PROFIBUS) in the Control Panel with "Set PG/PC interface". Restart the system. |
| 140005 | No tag updating or writing is executed because the HMI device address is incorrect (possibly too high). | Use a different HMI device address. Verify the connection and check whether the PLC is switched on. Check the parameter definitions in the Control Panel using "Set PG/PC interface". Restart the system. |

| Number | Effect/cause | Remedy |
|--------|---|---|
| 140006 | No tag updating or writing is executed because the baud rate is incorrect. | Select a different baud rate in WinCC flexible (according to module, profile, communication peer, etc.). |
| 140007 | Tag are not updated or written because the bus profile is incorrect (see %1). The following parameter could not be written to the registry: 1: Tslot 2: Tqui 3: Tset 4: MinTsdr 5: MaxTsdr 6: Trdy 7: Tid1 8: Tid2 9: Gap Factor 10: Retry Limit | Check the user-defined bus profile. Check the connection and if the PLC is switched on. Check the parameter definitions in the Control Panel using "Set PG/PC interface". Restart the system. |
| 140008 | No tag updating or writing is executed because baud rate is incorrect. The following parameters could not be written to the registry: 0: General error 1: Wrong version 2: Profile cannot be written to the registry. 3: The subnet type cannot be written to the registry. 4: The Target Rotation Time cannot be written to the registry. 5: Faulty Highest Address (HSA). | Check the connection and if the PLC is switched on. Check the parameter definitions in the Control Panel using "Set PG/PC interface". Restart the system. |
| 140009 | Tags are not updated or written because the module for S7 communication was not found. | Reinstall the module in the Control Panel using "Set PG/PC interface". |
| 140010 | No S7 communication partner found because the PLC is shut down. DP/T: The option "PG/PC is the only master" is not set in the Control Panel under "Set PG/PC interface." | Switch the PLC on. DP/T: If only one master is connected to the network, disable "PG/PC is the only master" in "Set PG/PC interface". If several masters are connected to the network, enable these. Do not change any settings, for this will cause bus errors. |
| 140011 | No tag updating or writing is executed because communication is down. | Check the connection and that the communication partner is switched on. |
| 140012 | There is an initialization problem (e.g. when WinCC flexible Runtime was closed in Task Manager). Or: Another application (e.g. STEP7) with different bus parameters is active and the driver cannot be started with the new bus parameters (transmission rate, for example). | Restart the HMI device. Or: Run WinCC flexible Runtime, then start your other applications. |
| 140013 | The MPI cable is disconnected and, thus, there is no power supply. | Check the connections. |
| 140014 | The configured bus address is in already in use by another application. | Edit the HMI device address in the PLC configuration. |

| Number | Effect/cause | Remedy |
|--------|--|---|
| 140015 | Wrong transmission rate Or: Faulty bus parameters (e.g. HSA) Or: OP address > HSA or: Wrong interrupt vector (interrupt does not arrive at the driver) | Correct the relevant parameters. |
| 140016 | The hardware does not support the configured interrupt. | Change the interrupt number. |
| 140017 | The set interrupt is in use by another driver. | Change the interrupt number. |
| 140018 | The consistency check was disabled by SIMOTION Scout. Only a corresponding note appears. | Enable the consistency check with SIMOTION Scout and once again download the project to the PLC. |
| 140019 | SIMOTION Scout is downloading a new project to the PLC. Connection to the PLC is canceled. | Wait until the end of the reconfiguration. |
| 140020 | The version in the PLC and that of the project (FWX file) do not match. Connection to the PLC is canceled | The following remedies are available: Download the current version to the PLC using SIMOTION Scout. Regenerate the project using WinCC flexible ES, close WinCC flexible Runtime and restart with a new configuration. |
| 150000 | No more data is read or written. Possible causes: <ul style="list-style-type: none"> • The cable is defective • The PLC does not respond, is defective, etc. • The wrong port is used for the connection • System overload | Ensure that the cable is plugged in, the PLC is operational, the correct port is being used. Restart the system if the system alarm persists. |
| 150001 | Connection is up because the cause of the interruption has been eliminated. | — |
| 160000 | No more data is read or written. Possible causes: <ul style="list-style-type: none"> • The cable is defective • The PLC does not respond, is defective, etc. • The wrong port is used for the connection • System overload | Ensure that the cable is plugged in, the PLC is operational, the correct port is being used. Restart the system if the system alarm persists. |
| 160001 | Connection is up because the cause of the interruption has been eliminated. | — |
| 160010 | No connection to the server because the server identification (CLS-ID) cannot be determined. Values cannot be read or written. | Check access rights. |
| 160011 | No connection to the server because the server identification (CLS-ID) cannot be determined. Values cannot be read or written. | Check, for example, if <ul style="list-style-type: none"> • The server name is correct • The computer name is correct • The server is registered |
| 160012 | No connection to the server because the server identification (CLS-ID) cannot be determined. Values cannot be read or written. | Check, for example, if <ul style="list-style-type: none"> • The server name is correct • The computer name is correct • The server is registered Note for advanced users: Interpret the value from HRESULT. |

| Number | Effect/cause | Remedy |
|--------|--|--|
| 160013 | The specified server was started as InProc server. This has not been released and may possibly lead to incorrect behavior because the server is running in the same process area as the WinCC flexible Runtime software. | Configure the server as OutProc Server or Local Server. |
| 160014 | Only one OPC server project can be started on a PC/MP. An alarm is output when an attempt is made to start a second project. The second project has no OPC server functionality and cannot be located as an OPC server by external sources. | Do not start a second project with OPC server functionality on the computer. |
| 170000 | S7 diagnostics events are not indicated because it is not possible to log on to the S7 diagnostics functions at this device. The service is not supported. | — |
| 170001 | The S7 diagnostics buffer cannot be viewed because communication with the PLC is shut down. | Set the PLC to online mode. |
| 170002 | The S7 diagnostics buffer cannot be viewed because reading of the diagnostics buffer (SSL) was canceled with error. | — |
| 170003 | An S7 diagnostics event cannot be visualized. The system returns internal error %2. | — |
| 170004 | An S7 diagnostics event cannot be visualized. The system returns an internal error of error class %2, error number %3. | — |
| 170007 | It is not possible to read the S7 diagnostics buffer (SSL) because this operation was canceled with an internal error of class %2 and error code %3. | — |
| 180000 | A component/OCX received configuration data with a version ID which is not supported. | Install a newer component. |
| 180001 | System overload because too many actions running in parallel. Not all the actions can be executed, some are rejected. | Several remedies are available: <ul style="list-style-type: none"> • Increase the configured cycle times or basic clock • Generate the alarms at a slower rate (polling) • Initiate scripts and functions at greater intervals If the alarm appears more frequently: Restart the HMI device. |
| 180002 | The screen keyboard could not be activated. Possible causes: "TouchInputPC.exe" was not registered due to a faulty Setup. | Reinstall WinCC flexible Runtime. |
| 190000 | It is possible that the tag is not updated. | — |
| 190001 | The tag is updated after the cause of the last error state has been eliminated (return to normal operation). | — |
| 190002 | The tag is not updated because communication with the PLC is down. | Select the system function "SetOnline" to go online. |
| 190004 | The tag is not updated because the configured tag address does not exist. | Check the configuration. |
| 190005 | The tag is not updated because the configured PLC type does not exist for this tag. | Check the configuration. |

| Number | Effect/cause | Remedy |
|--------|--|---|
| 190006 | The tag is not updated because it is not possible to map the PLC type in the data type of the tag. | Check the configuration. |
| 190007 | The tag value is not modified because the connection to the PLC is interrupted or the tag is offline. | Set online mode or reconnect to the PLC. |
| 190008 | The threshold values configured for the tag have been violated, for example, by <ul style="list-style-type: none"> • A value entered • A system function • A script | Observe the configured or current threshold values of the tag. |
| 190009 | An attempt has been made to assign the tag a value which is outside the permitted range of values for this data type. For example, a value of 260 was entered for a byte tag or a value of -3 for an unsigned word tag. | Observe the range of values for the data type of the tags. |
| 190010 | Too many values are written to the tag (for example, in a loop triggered by a script). Values are lost because only up to 100 actions are saved to the buffer. | Increase the time interval between multiple write actions. |
| 190011 | Possible cause 1: The value entered could not be written to the configured PLC tag because the high or low limit was exceeded. The system discards the entry and restores the original value. Possible cause 2: The connection to the PLC was interrupted. | Make sure that the value entered lies within the range of values of the control tags. Check the connection to the PLC. |
| 190012 | It is not possible to convert a value from a source format to a target format, for example: An attempt is being made to assign a value to a counter that is outside the valid, PLC-specific value range. A tag of the type Integer should be assigned a value of the type String. | Check the range of values or the data type of the tags. |
| 190100 | The area pointer is not updated because the address configured for this pointer does not exist. Type 1 Warning alarms 2 Error alarms 3 PLC acknowledgment 4 HMI device acknowledgment 5 LED mapping 6 Trend request 7 Trend transfer 1 8 Trend transfer 2 No.: consecutive number shown in WinCC flexible ES. | Check the configuration. |
| 190101 | The area pointer is not updated because it is not possible to map the PLC type to the area pointer type. Parameter type and no.: see alarm 190100 | — |

| Number | Effect/cause | Remedy |
|--------|---|---|
| 190102 | The area pointer is updated after the cause of the last error state has been eliminated (return to normal operation). Parameter type and no.: See alarm 190100 | — |
| 200000 | Coordination is not executed because the address configured in the PLC does not exist/is not set. | Change the address or set up the address in the PLC. |
| 200001 | Coordination is canceled because the write access to the address configured in the PLC is not possible. | Change the address or set the address in the PLC at an area which allows write access. |
| 200002 | Coordination is not carried out at the moment because the address format of the area pointer does not match the internal storage format. | Internal error |
| 200003 | Coordination can be executed again because the last error state is eliminated (return to normal operation). | — |
| 200004 | The coordination may not be executed. | — |
| 200005 | No more data is read or written. Possible causes: <ul style="list-style-type: none"> • The cable is defective • The PLC does not respond, is defective, etc. • System overload | Ensure that the cable is plugged in and the PLC is operational. Restart the system if the system alarm persists. |
| 200100 | Coordination is not executed because the address configured in the PLC does not exist/is not set. | Change the address or set up the address in the PLC. |
| 200101 | Coordination is canceled because the write access to the address configured in the PLC is not possible. | Change the address or set the address in the PLC at an area which allows write access. |
| 200102 | Coordination is not carried out at the moment because the address format of the area pointer does not match the internal storage format. | Internal error |
| 200103 | Coordination can be executed again because the last error state is eliminated (return to normal operation). | — |
| 200104 | The coordination may not be executed. | — |
| 200105 | No more data is read or written. Possible causes: <ul style="list-style-type: none"> • The cable is defective • The PLC does not respond, is defective, etc. • System overload | Ensure that the cable is plugged in and the PLC is operational. Restart the system if the system alarm persists. |
| 210000 | Jobs are not processed because the address configured in the PLC does not exist/has not been set up. | Change the address or set up the address in the PLC. |
| 210001 | Jobs are not processed because read/write access to the address configured in the PLC is not possible. | Change the address or set up the address in the PLC in an area which allows read/write access. |
| 210002 | Jobs are not executed because the address format of the area pointer does not match the internal storage format. | Internal error |
| 210003 | The job buffer is processed again because the last error status has been eliminated (return to normal operation). | — |
| 210004 | It is possible that the job buffer will not be processed. | — |
| 210005 | A control request with an illegal number was initiated. | Check the PLC program. |
| 210006 | An error occurred while attempting to execute the control request. As a result, the control request is not executed. Observe the next/previous system alarms. | Check the parameters of the control request. Recompile the configuration. |

| Number | Effect/cause | Remedy |
|--------|---|---|
| 220001 | The tag is not downloaded because the associated communication driver / HMI device does not support the download of Boolean/discrete data types. | Change the configuration. |
| 220002 | The tag is not downloaded because the associated communication driver / HMI device does not support write access to the data type BYTE. | Change the configuration. |
| 220003 | The communication driver cannot be loaded. The driver may not be installed. | Install the driver by reinstalling WinCC flexible Runtime. |
| 220004 | Communication is down and no update data is transferred because the cable is not connected or defective etc. | Check the connection. |
| 220005 | Communication is up. | — |
| 220006 | The connection between the specified PLC and the specified port is active. | — |
| 220007 | The connection to the specified PLC is interrupted at the specified port. | Check whether <ul style="list-style-type: none"> • The cable is plugged in • The PLC is OK • The correct port is used • Your configuration is OK (port parameters, protocol settings, PLC address) Restart the system if the system alarm persists. |
| 220008 | The communication driver cannot access or open the specified port. The port may be in use by another application or the port used is not available on the destination device. There is no communication with the PLC. | Close all the applications which access this port and restart the computer. Use another port of the system. |
| 230000 | The value entered could not be accepted. The system discards the entry and restores the previous value. Either <ul style="list-style-type: none"> • The value range has been exceeded • Illegal characters have been entered • The maximum permitted number of users has been exceeded | Enter a practical value or delete any unneeded users. |
| 230002 | The currently logged in user has not the required authorization. The system therefore discards the input and restored the previous value. | Log on as a user with appropriate authorization. |
| 230003 | Changeover to the specified screen failed because the screen is not available/configured. The current screen remains selected. | Configure the screen and check the screen selection function. |
| 230005 | The value range of the tag has been exceeded in the I/O field. The original value of the tag is retained. | Observe the range of values for the tag when entering a value. |
| 230100 | During navigation in the web browser, the system returned a message which may be of interest to the user. The web browser continues to run but may not (fully) show the new page. | Navigate to another page. |

| Number | Effect/cause | Remedy |
|--------|--|---|
| 230200 | The connection to the HTTP channel was interrupted due to an error. This error is explained in detail by another system alarm. Data is no longer exchanged. | Check the network connection. Check the server configuration. |
| 230201 | The connection to HTTP channel was established. Data is exchanged. | — |
| 230202 | WININET.DLL has detected an error. This error usually occurs when an attempt to connect to the server fails or the server refuses to connect because the client lacks the proper authorization. An unknown server certificate may also be the cause if the connection is encrypted by means of SSL. The alarm text provides details. This text is always in the language of the Windows installation because it is returned by the Windows OS. Process values are no longer exchanged. | Depending on the cause: When an attempt to connect fails or a timeout error occurs: <ul style="list-style-type: none"> • Check the network connection and the network • Check the server address • Check whether the web server is actually running on the destination computer Faulty authorization: <ul style="list-style-type: none"> • The configured user name and/or password do not match those on the server. Establish consistency When the server certificate is rejected: Certificate signed by an unknown CA (): <ul style="list-style-type: none"> • Either ignore this item in your project, or • Install a certificate that has been signed with a root certificate known to the client computer If the date of certificate is invalid: <ul style="list-style-type: none"> • Either ignore this item in your project, or • Install a certificate with a valid date on the server Invalid CN (Common Name or Computer Name): <ul style="list-style-type: none"> • Either ignore this item in your project, or • Install a certificate with a name that corresponds to that of the server address |
| 230203 | Although a connection can be made to the server, the HTTP server refuses to connect because <ul style="list-style-type: none"> • WinCC flexible Runtime is not running on the server, or • The HTTP channel is not supported (503 Service unavailable) Other errors can only occur if the web server does not support the HTTP channel. The language of the alarm text depends on the web server. Data is not exchanged. | Error 503 Service unavailable: Check whether <ul style="list-style-type: none"> • WinCC flexible Runtime is running on the server • The HTTP channel is supported |
| 230301 | An internal error has occurred. An English text explains the error in more detail. This may be caused by insufficient memory. OCX does not work. | — |
| 230302 | The name of the remote server cannot be resolved. The attempt to connect failed. | Check the configured server address. Check whether the DNS service is available on the network. |
| 230303 | The remote server is not running on the addressed computer. Wrong server address. The attempt to connect failed | Check the configured server address. Check whether the remote server is running on the target computer. |

| Number | Effect/cause | Remedy |
|--------|---|---|
| 230304 | The remote server on the addressed computer is incompatible to VNCOCX. The attempt to connect failed. | Use a compatible remote server. |
| 230305 | The authentication has failed because the password is incorrect. The attempt to connect failed. | Configure the correct password. |
| 230306 | Error in the connection to the remote server. This may occur as a result of network problems. The attempt to connect failed. | Check whether <ul style="list-style-type: none"> • The bus cable is plugged in • There are network problems |
| 230307 | The connection to the remote server was shut down because <ul style="list-style-type: none"> • The remote server was shut down, or • The user instructed the server to close all connections The connection is closed. | — |
| 230308 | This alarm provides information on the connection status. An attempt is made to connect. | — |
| 240000 | WinCC flexible Runtime is operating in demo mode. You have no authorization or your authorization is corrupted. | Install the authorization. |
| 240001 | WinCC flexible Runtime is operating in demo mode. Too many tags are configured for the installed version. | Load an adequate authorization / powerpack. |
| 240002 | WinCC flexible Runtime is operating with a time-limited emergency authorization. | Restore the full authorization. |
| 240003 | Authorization failed. Without authorization, WinCC flexible Runtime will run in demo mode. | Restart WinCC flexible Runtime or reinstall it. |
| 240004 | Error while reading the emergency authorization. WinCC flexible Runtime is operating in demo mode. | Restart WinCC flexible Runtime, install the authorization or repair the authorization (see Commissioning Instructions Software Protection). |
| 240005 | The Automation License Manager has detected an internal system fault. Possible causes: <ul style="list-style-type: none"> • A corrupt file • A defective installation • No free space for the Automation License Manager etc. | Reboot the HMI device/PC. If this does not solve the problem, remove the Automation License Manager and install it again. |
| 250000 | The tag in the specified line in "Status force" is not updated because the address configured for this tag is not available. | Check the set address and then verify that the address is set up in the PLC. |
| 250001 | The tag in the specified line in "Status force" is not updated because the PLC type configured for this tag does not exist. | Check the set address. |
| 250002 | The tag in the specified line in "Status force" is not updated because it is not possible to map the PLC type in the tag type. | Check the set address. |

| Number | Effect/cause | Remedy |
|--------|--|--|
| 250003 | An attempt to connect to the PLC failed. The tags are not updated. | Check the connection to the PLC. Check that the PLC is switched on and is online. |
| 260000 | An unknown user or an unknown password has been entered in the system. The current user is logged off from the system. | Log on to the system as a user with a valid password. |
| 260001 | The logged in user does not have sufficient authorization to execute the protected functions on the system. | Log on to the system as a user with sufficient authorization. |
| 260002 | This alarm is triggered by the system function "TrackUserChange". | — |
| 260003 | The user has logged off from the system. | — |
| 260004 | The user name entered into the user view already exists in the user management. | Select another user name because user names have to be unique in the user management. |
| 260005 | The entry is discarded. | Use a shorter user name. |
| 260006 | The entry is discarded. | Use a shorter or longer password. |
| 260007 | The logon timeout value entered is outside the valid range of 0 to 60 minutes. The new value is discarded and the original value is retained. | Enter a logon timeout value between 0 and 60 minutes. |
| 260008 | An attempt was made to read a PTProRun.pwl file created with ProTool V 6.0 in WinCC flexible. Reading the file was canceled due to incompatibility of the format. | — |
| 260009 | You have attempted to delete the user "Admin" or "PLC User". These users are fixed components of the user management and cannot be deleted. | If you need to delete a user, because perhaps you have exceeded the maximum number permitted, delete another user. |
| 260012 | The passwords entered in the "Change Password" dialog and the confirmation field are not identical. The password has not been changed. User will be logged off. | You have to log on to the system again. Then enter the identical password twice to be able to change the password. |
| 260013 | The password entered in the "Change Password" dialog is invalid because it is already in use. The password has not been changed. User will be logged off. | You have to log on to the system again. Then enter a new password that has not been used before. |
| 260014 | User has unsuccessfully attempted to log on 3 times in succession. The user has been locked out and assigned to group no. 0. | You can log on to the system with your correct password. Only an administrator can change the assignment to a group. |
| 270000 | A tag is not indicated in the alarm because it attempts to access an invalid address in the PLC. | Check whether the data area for the tag exists in the PLC, the configured address is correct and the value range for the tag is correct. |
| 270001 | There is a device-specific limit as to how many alarms may be queued for output (see the operating instructions). This limit has been exceeded. The view no longer contains all the alarms. However, all alarms are written to the alarm buffer. | — |
| 270002 | The view shows alarms of a log for which there is no data in the current project. Wildcards are output for the alarms. | Delete older log data if necessary. |

| Number | Effect/cause | Remedy |
|--------|--|--|
| 270003 | The service cannot be set up because too many devices want to use this service. A maximum of four devices may execute this action. | Reduce the number of HMI devices which want to use the service. |
| 270004 | Access to persistent buffer is not possible. Alarms cannot be restored or saved. | If the problems persist at the next startup, contact Customer Support (delete Flash). |
| 270005 | Persistent buffer damaged: Alarms cannot be restored. | If the problems persist at the next startup, contact Customer Support (delete Flash). |
| 270006 | Project modified: Alarms cannot be restored from the persistent buffer. | The project was generated and transferred new to the HMI device; The error should no longer occur when the device starts again. |
| 270007 | A configuration problem is preventing the restore (a DLL is missing, a directory is unknown, etc.). | Update the operating system and then transfer your project again to the HMI device. |
| 280000 | Connection is up because the cause of the interruption has been eliminated. | — |
| 280001 | No more data is read or written. Possible causes: <ul style="list-style-type: none"> • The cable is defective • The PLC does not respond, is defective, etc. • The wrong port is used for the connection • System overload | Check whether <ul style="list-style-type: none"> • The cable is plugged in • The PLC is OK • The correct port is used Restart the system if the system alarm persists. |
| 280002 | The connection used requires a function block in the PLC. The function block has responded. Communication is now enabled. | — |
| 280003 | The connection used requires a function block in the PLC. The function block has not responded. | Check whether <ul style="list-style-type: none"> • The cable is plugged in • The PLC is OK • The correct port is used Restart the system if the system alarm persists. Remedy depends on the error code: <ol style="list-style-type: none"> 1: The function block must set the COM bit in the response container. 2: The function block must not set the ERROR bit in the response container. 3: The function block must respond within the specified time (timeout). 4: Go online to the PLC. |
| 280004 | The connection to the PLC is interrupted. There is no data exchange at present. | Check the connection parameters in WinCC flexible. Ensure that the cable is plugged in, the PLC is operational, the correct port is being used. Restart the system if the system alarm persists. |
| 290000 | The recipe tag could not be read or written. It is assigned the start value. The alarm can be entered in the alarm buffer for up to four more failed tags if necessary. After that, alarm 290003 is output. | Check in the configuration that the address has been set up in the PLC. |

| Number | Effect/cause | Remedy |
|--------|--|--|
| 290001 | An attempt has been made to assign a value to a recipe tag which is outside the value range permitted for this type. The alarm can be entered in the alarm buffer for up to four more failed tags if necessary. After that, alarm 290004 is output. | Observe the value range for the tag type. |
| 290002 | It is not possible to convert a value from a source format to a target format. The alarm can be entered in the alarm buffer for up to four more failed recipe tags if necessary. After that, alarm 290005 is output. | Check the value range or type of the tag. |
| 290003 | This alarm is output when alarm number 290000 is triggered more than five times. In this case, no further separate alarms are generated. | Check in the configuration that the tag addresses have been set up in the PLC. |
| 290004 | This alarm is output when alarm number 290001 is triggered more than five times. In this case, no further separate alarms are generated. | Observe the value range for the tag type. |
| 290005 | This alarm is output when alarm number 290002 is triggered more than five times. In this case, no further separate alarms are generated. | Check the value range or type of the tag. |
| 290006 | The threshold values configured for the tag have been violated by values entered. | Observe the configured or current threshold values of the tag. |
| 290007 | There is a difference between the source and target structure of the recipe currently being processed. The target structure contains an additional data recipe tag which is not available in the source structure. The data recipe tag specified is assigned its start value. | Insert the specified data recipe tag in the source structure. |
| 290008 | There is a difference between the source and target structure of the recipe currently being processed. The source structure contains an additional data recipe tag which is not available in the target structure and therefore cannot be assigned. The value is rejected. | Remove the specified data recipe tag in the specified recipe from the project. |
| 290010 | The storage location configured for the recipe is not permitted. Possible causes: Illegal characters, write protection, data carrier out of space or does not exist. | Check the configured storage location. |
| 290011 | The record with the specified number does not exist. | Check the source for the number (constant or tag value) |
| 290012 | The recipe with the specified number does not exist. | Check the source for the number (constant or tag value) |
| 290013 | An attempt was made to save a record under a record number which already exists. The action is not executed. | The following remedies are available: <ul style="list-style-type: none"> • Check the source for the number (constant or tag value) • First, delete the record • Change the "Overwrite" function parameter |
| 290014 | The file specified to be imported could not be found. | Check: <ul style="list-style-type: none"> • The file name • Ensure that the file is in the specified directory |

| Number | Effect/cause | Remedy |
|--------|--|---|
| 290020 | Alarm reporting that the download of records from the HMI device to the PLC has started. | — |
| 290021 | Alarm reporting that the download of records from the HMI device to the PLC was completed. | — |
| 290022 | Alarm reporting that the download of records from the HMI device to the PLC was canceled due to an error. | Check in the configuration whether: <ul style="list-style-type: none"> • The tag addresses are configured in the PLC • The recipe number exists • The record number exist • The "Overwrite" function parameter is set |
| 290023 | Alarm reporting that the download of records from the PLC to the HMI device has started. | — |
| 290024 | Alarm reporting that the download of records from the PLC to the HMI device was completed. | — |
| 290025 | Alarm reporting that the download of records from the PLC to the HMI device was canceled due to an error. | Check in the configuration whether: <ul style="list-style-type: none"> • The tag addresses are configured in the PLC • The recipe number exists • The record number exist • The "Overwrite" function parameter is set |
| 290026 | An attempt has been made to read/write a record although the record is not free at present. This error may occur in the case of recipes for which downloading with synchronization has been configured. | Set the record status to zero. |
| 290027 | Unable to connect to the PLC at present. As a result, the record can neither be read nor written. Possible causes: No physical connection to the PLC (no cable plugged in, cable is defect) or the PLC is switched off. | Check the connection to the PLC. |
| 290030 | This alarm is output after you selected screen which contains a recipe view in which a record is already selected. | Reload the record from the storage location or retain the current values. |
| 290031 | While saving, it was detected that a record with the specified number already exists. | Overwrite the record or cancel the action. |
| 290032 | While exporting records it was detected that a file with the specified name already exists. | Overwrite the file or cancel the process. |
| 290033 | Confirmation request before deleting records. | — |
| 290040 | A record error with error code %1 that cannot be described in more detail occurred. The action is canceled. It is possible that the record was not installed correctly on the PLC. | Check the storage location, the record, the "Data record" area pointer and if necessary, the connection to the PLC. Restart the action after a short time. If the error persists, contact Customer Support. Forward the relevant error code to Customer Support. |
| 290041 | A record or file cannot be saved because the storage location is full. | Delete files no longer required. |
| 290042 | An attempt was made to execute several recipe actions simultaneously. The last action was not executed. | Trigger the action again after waiting a short period. |
| 290043 | Confirmation request before storing records. | — |

| Number | Effect/cause | Remedy |
|--------|---|--|
| 290044 | The data store for the recipe has been destroyed and is deleted. | — |
| 290050 | Alarm reporting that the export of records has started. | — |
| 290051 | Alarm reporting that the export of records was completed. | — |
| 290052 | Alarm reporting that the export of records was canceled due to an error. | Ensure that the structure of the records at the storage location and the current recipe structure on the HMI device are identical. |
| 290053 | Alarm reporting that the import of records has started. | — |
| 290054 | Alarm reporting that the import of records was completed. | — |
| 290055 | Alarm reporting that the import of records was canceled due to an error. | Ensure that the structure of the records at the storage location and the current recipe structure on the HMI device are identical. |
| 290056 | Error when reading/writing the value in the specified line/column. The action was canceled. | Check the specified line/column. |
| 290057 | The tags of the recipe specified were toggled from "offline" to "online" mode. Each change of a tag in this recipe is now immediately downloaded to the PLC. | — |
| 290058 | The tags of the specified recipe were toggled from "offline" to "online" mode. Modifications to tags in this recipe are no longer immediately transferred to the PLC but must be transferred there explicitly by downloading a record. | — |
| 290059 | Alarm reporting that the specified record was saved. | — |
| 290060 | Alarm reporting that the specified record memory was cleared. | — |
| 290061 | Alarm reporting that clearing of record memory was canceled due to an error. | — |
| 290062 | The record number is above the maximum of 65536. This record cannot be created. | Select another number. |
| 290063 | This occurs with the system function "ExportDataRecords" when the parameter "Overwrite" is set to No. An attempt has been made to save a recipe under a file name which already exists. The export is canceled. | Check the "ExportDataRecords" system function. |
| 290064 | Alarm reporting that the deletion of records has started. | — |
| 290065 | Alarm reporting that the deletion of records has successfully completed. | — |
| 290066 | Confirmation request before deleting records. | — |
| 290068 | Security request to confirm if all records in the recipe should be deleted. | — |
| 290069 | Security request to confirm if all records in the recipe should be deleted. | — |
| 290070 | The record specified is not in the import file. | Check the source of the record number or record name (constant or tag value). |

| Number | Effect/cause | Remedy |
|--------|---|--|
| 290071 | During the editing of record values, a value was entered which exceeded the low limit of the recipe tag. The entry is discarded. | Enter a value within the limits of the recipe tag. |
| 290072 | When editing record values, a value was entered which exceeds the high limit of the recipe tag. The entry is discarded. | Enter a value within the limits of the recipe tag. |
| 290073 | An action (e.g. saving a record) failed due to an unknown error. The error corresponds to the status alarm IDS_OUT_CMD_EXE_ERR in the large recipe view. | — |
| 290074 | While saving, it was detected that a record with the specified number already exists but under another name. | Overwrite the record, change the record number or cancel the action. |
| 290075 | A record with this name already exists. The record is not saved. | Please select a different record name. |
| 300000 | Faulty configuration of process monitoring (e.g. using PDiag or S7-Graph): More alarms are queued than specified in the specifications of the CPU. No further ALARM_S alarms can be managed by the PLC and reported to the HMI devices. | Change the PLC configuration. |
| 300001 | ALARM_S is not registered on this PLC. | Select a PLC that supports the ALARM_S service. |
| 310000 | An attempt is being made to print too many reports in parallel. Only one log file can be output to the printer at a given time; the print job is therefore rejected. | Wait until the previous active log was printed. Repeat the print job if necessary. |
| 310001 | An error occurred on triggering the printer. The report is either not printed or printed with errors. | Evaluate the additional system alarms related to this alarm. Repeat the print job if necessary. |
| 320000 | The movements have already been indicated by another device. The movements can no longer be controlled. | Deselect the movements on the other display units and select the motion control screen on the required display unit. |
| 320001 | The network is too complex. The faulty addresses cannot be indicated. | View the network in STL. |
| 320002 | No diagnostics alarm selected. The unit belonging to the alarm could not be selected. | Select a diagnostics alarm from the ZP_ALARM alarm screen. |
| 320003 | No alarms exists for the selected unit. The detail view cannot visualize any networks. | Select the defective unit from the overview screen. |
| 320004 | The required signal states could not be read by the PLC. The faulty addresses cannot be found. | Check the consistency between the configuration on the display unit and the PLC program. |
| 320005 | The project contains ProAgent elements which are not installed. ProAgent diagnostic functions cannot be performed. | In order to run the project, install the optional ProAgent package. |
| 320006 | You have attempted to execute a function which is not supported in the current constellation. | Check the type of the selected unit. |
| 320007 | No error-triggering addresses were found on the networks. ProAgent cannot indicate any faulty addresses. | Switch the detail screen to STL layout mode and check the status of the addresses and exclusion addresses. |
| 320008 | The diagnostic data stored in the configuration are not synchronized with those in the PLC. ProAgent can only indicate the diagnostic units. | Transfer the project to the HMI device again. |

| Number | Effect/cause | Remedy |
|--------|--|---|
| 320009 | The diagnostic data stored in the configuration are not synchronized with those in the PLC. The diagnostic screens can be operated as usual. ProAgent may be unable to show all diagnostic texts. | Transfer the project to the HMI device again. |
| 320010 | The diagnostic data stored in the configuration are not synchronized with those in STEP7. The ProAgent diagnostics data is not up-to-date. | Transfer the project to the HMI device again. |
| 320011 | A unit with the corresponding DB number and FB number does not exist. The function cannot be executed. | Check the parameters of the "SelectUnit" function and the units selected in the project. |
| 320012 | The "Step sequence mode" dialog is no longer supported. | Use the ZP_STEP step sequence screen from the corresponding standard project for your project. Instead of calling the Overview_Step_Sequence_Mode function, call the "FixedScreenSelection" function using ZP_STEP as the screen name. |
| 320014 | The selected PLC cannot be evaluated for ProAgent. The Alarm view assigned to the "EvaluateAlarmDisplayFault" system function could not be found. | Check the parameters of the "EvaluateAlarmDisplayFault" system function. |
| 330022 | Too many dialogs are open on the HMI device. | Close all dialogs you do not require on the HMI device. |

Abbreviations

| | |
|-------|--|
| ANSI | American National Standards Institution |
| CPU | Central Processing Unit |
| CSV | Comma Separated Values |
| CTS | Clear To Send |
| DC | Direct Current |
| DCD | Data Carrier Detect |
| DHCP | Dynamic Host Configuration Protocol |
| DIL | Dual-in-Line (electronic chip housing design) |
| DNS | Domain Name System |
| DP | Distributed I/O |
| DSN | Data Source Name |
| DSR | Data Set Ready |
| DTR | Data Terminal Ready |
| IO | Input and Output |
| ESD | Components and modules endangered by electrostatic discharge |
| EMC | Electromagnetic Compatibility |
| EN | European standard |
| ES | Engineering System |
| ESD | Components and modules endangered by electrostatic discharge |
| GND | Ground |
| HF | High Frequency |
| HMI | Human Machine Interface |
| IEC | International Electronic Commission |
| IF | Interface |
| IP | Internet Protocol |
| LED | Light Emitting Diode |
| MAC | Media Access Control |
| MOS | Metal Oxide Semiconductor |
| MPI | Multipoint Interface (SIMATIC S7) |
| MS | Microsoft |
| MTBF | Mean Time Between Failures |
| n. c. | Not connected |
| OP | Operator Panel |
| PC | Personal Computer |
| PG | Programming device |
| PPI | Point-to-Point Interface (SIMATIC S7) |
| RAM | Random Access Memory |

| | |
|---------|---|
| PELV | Protective Extra Low Voltage |
| RJ45 | Registered Jack Type 45 |
| RTS | Request to send |
| RxD | Receive Data |
| SD Card | Security Digital Card |
| SELV | Safety Extra Low Voltage |
| SP | Service Pack |
| PLC | Programmable Logic Controller |
| STN | Super Twisted Nematic |
| Sub-D | Subminiature D (plug) |
| TAB | Tabulator |
| TCP/IP | Transmission Control Protocol/Internet Protocol |
| TFT | Thin Film Transistor |
| TTY | Teletype |
| TxD | Transmit Data |
| UL | Underwriter's Laboratory |
| USB | Universal Serial Bus |
| WINS | Windows Internet Naming Service |

Glossary

Acknowledge

Acknowledgment of an alarm confirms that it has been noted.

Alarm logging

Output of user-specific alarms to a printer, in parallel to their output to the HMI device screen.

Alarm, acknowledgment

Acknowledgment of an alarm confirms that it has been noted.

Alarm, activated

Moment at which an alarm is triggered by the PLC or HMI device.

Alarm, deactivated

Moment at which the initiation of an alarm is reset by the PLC.

Alarm, user-specific

A user-specific alarm report specific operating states of a plant interconnected to the HMI device via the PLC.

Automation device

An automation device is a PLC of the SIMATIC S5 series, for example the AG S5-115U

Automation system

An automation system is a PLC of the SIMATIC S7 series, for example SIMATIC S7-300

Boot loader

The boot loader is used to start the operating system and is started automatically after power on of the HMI device. The loader is displayed after the operating system has loaded.

Configuration PC

A configuration PC is a programming device or PC on which plant projects are created using an engineering software.

Configuration software

Configuration software is used to create projects used for the purpose of process visualization. WinCC flexible is such a configuration software, for example.

Controller

PLC is a general term for devices and systems with which the HMI device communicates, e.g. SIMATIC S7.

Degree of protection

The degree of protection specifies a standard of electronic equipment for a variety of environmental conditions – and the protection of humans against potential danger when using this equipment.

The degree of protection classified by IP differs from the protection class. But both involve protection against touching dangerous electric voltage. The degree of protection also classifies the protection of equipment against dirt and moisture.

Display duration

Defines whether a system alarm is displayed on the HMI device and the duration of the display.

EMC

Electromagnetic compatibility (EMC) refers to a usually desirable state, in which technical equipment does not disturb one another with unwanted electrical or electromagnetic effects. Electromagnetic compatibility deals with technical and regulatory questions of undesired, mutual influence in electrical engineering.

Event

Functions are triggered by defined incoming events. Events can be configured. Events which can be assigned to a button include "Press" and "Release", for example.

Field

Area reserved in configured screens for the input and output of values.

Flash memory

Flash memory is a non-volatile memory with EEPROM chips that is implemented either as mobile storage medium, or as permanently installed memory module on the motherboard.

Function keys

Function keys on the HMI device can be assigned user-specific functions. The functions assigned to these keys are defined during configuration. The assignment of the function keys may be specific to an active screen or independent of it.

Half Brightness Life Time

Time period after which brightness is reduced to 50% of the original value. The specified value depends on the operating temperature.

Hardcopy

Output of the screen content to a printer.

HMI device

An HMI device is a device used for the operation and monitoring of machines and plants. The machine or plant states are visualized on the HMI device by means of graphic objects or signal lamps. The operator controls of the HMI device allow the operator to interact with the processes of the machine or plant.

HMI device image

The HMI device image is a file that can be transferred from the configuration PC to the HMI device. The HMI device image contains the operating system for the HMI device and the elements of the runtime software required to run a project.

I/O field

An I/O field enables the input or output of values on the HMI device which are transferred to the PLC.

Info text

An infotext is a configured information on objects within a project. Infotext for an alarm, for example, may contain information on the cause of the fault and troubleshooting routines.

Object

An object is a project element such as a screen or an alarm. Objects are used to view or enter texts and values on the HMI device.

Operator control

An operator control is a component of a project used to enter values and trigger functions. A button, for example, is an operator control.

Plant

General term referring to machines, processing centers, systems, plants and processes which are operated and monitored on an HMI device.

PLC job

A PLC job triggers a function for the PLC on the HMI device.

Process visualization

Process visualization is the representation of technical processes by means of text and graphic elements. Configured plant screens allow operator intervention in active plant processes using the input and output data.

Project

A project is the result of a configuration using a configuration software. The project normally contains several screens with embedded system-specific objects, basic settings and alarms. A project configured in WinCC flexible is saved to a project file with the extension *.hmi.

You need to distinguish between a project on the configuration PC and an executable project on an HMI device. A project on the configuration PC can be available in more languages than can be managed on the HMI device. The project on the configuration PC can also be set up for different HMI devices. You can only transfer an executable project to an HMI device if it has been especially compiled for it.

Project file

A project file is a file from which the executable project file for use on the HMI device is generated. The project file is usually not transferred and is retained on the configuration PC.

The file name extension of a project file is *.hmi.

Project file, compressed

Compressed format of the project file. The compressed project file can be transferred in addition to the executable project file to the corresponding HMI device. For this purpose, backtransfer must be enabled in the project on the configuration PC. The compressed project file is usually saved to an external memory card.

A compressed project file has the extension *.pdz.

Project file, executable

An executable project file is the file generated from the project file for a specific HMI device. The executable project file is transferred to the associated HMI device where it is used to operate and monitor plants.

An executable project file has the extension "*.fwx".

Protection class

The protection class is used in electrical engineering to classify and identify electrical equipment in relation to existing safety measures designed to prevent electric shock.

There are four protection classes for electrical equipment.

Recipe

A recipe is a combination of tags that form a fixed data structure. The configured data structure can be assigned data in the configuration software or on the HMI device and is then referred to as a record. The use of recipes ensures that all data assigned to a data record is transferred synchronously to the PLC.

Runtime software

The runtime software is a process visualization software used to test a project on a configuration PC.

Screen

A screen is a form of visualization for all logically related process data in a plant. The representation of the process data can be visually supported by graphic objects.

Screen object

A screen object refers to objects such as rectangles, I/O fields, or alarm views which are configured for visualization or operation of the plant.

STEP 7

STEP 7 is the programming software for SIMATIC S7, SIMATIC C7 and SIMATIC WinAC PLCs.

STEP 7 Micro/WIN

STEP 7 Micro/WIN is the programming software for SIMATIC S7-200 PLCs.

Symbolic I/O field

A symbolic I/O field is a field for the input and output of a value. Contains a list of default entries from which one can be selected.

System alarm

A system alarm is assigned to the "System" alarm class. A system alarm refers to internal states on the HMI device and the PLC.

Tab order

The tab order defined in the course of project engineering determines the sequence for activating objects by pressing the <TAB> key.

Tag

A tag is a defined memory location to which values can be written and from which values can be read. This can be done from the PLC or the HMI device. We distinguish between external tags (process tags) and internal tags, depending on whether or not the tag is interconnected with the PLC.

Transfer

Transfer of a runtime project from the configuration PC to the HMI device.

"Transfer" mode

The "Transfer" operating mode is an operating mode of the HMI device in which an executable project is transferred from the configuration PC to an HMI device.

WinAC MP

WinAC is a software PLC for multifunctional platforms.

Index

/

/Audit, 28

A

ACK, 211

ACK key, 175

Acknowledge

Alarm, 175, 215

Error alarm, 215

Acknowledge key, 175

Acoustic feedback, 163

Acoustic signal

Inadvertent operation, 163

Acoustics

Feedback, 103

Activate

Password protection, 94

Address assignment

TCP/IP network, 122

Addressing, 120

Admin, 206, 207, 208

Alarm, 209

Acknowledge, 175, 215

Display, 212

Editing, 216

Functional scope, 26

Alarm buffer, 210

Functional scope, 26

Alarm class, 210, 213

Alarm event, 209

Alarm group, 210

Alarm indicator, 211

Alarm line, 212

Alarm log, 210

Alarm report, 210

Alarm view, 212

Extended, 213

Simple, 212

Alarm window, 214

ALARM_S, 26

Alphanumeric

Key assignment, 87, 175

Screen keyboard, 170

Alphanumeric value

Changing, 171, 179

Entering, 171, 179

ALT key, 87, 175

Applications

MP 277, 13

Approval for Australia, 33

Approvals, 32

Audible signal, 169

Authorization, 197

Automatic

Transfer, 142

A-Z key, 87, 175

B

Backing up, 140, 146, 147, 149, 198

Registry information, 80

Registry Information, 98

Temporary files, 98

To memory card, 79

With ProSave, 149

With WinCC flexible, 147

Backlighting

Reducing, 100

Setting, 80

Backspace key, 86, 175

Backtransfer, 141, 144

Backup, 79, 133

to external storage device, 131

Bar, 182

Booting, 105

Bottom view, 14, 16, 18, 20

Brightness

Changing, 99

Browser

Home page, 79

Setting, 79

Bus connection, 29

Bus parameters

Profile, 114

C

Cable

Connecting, 49

Calibrating

Touch screen, 92

Cancel

Secure mode, 77

- Cancel key, 86, 175
 - Care, 247
 - CE approval, 32
 - Certificate
 - Delete, 129
 - Deleting, 79
 - Displaying, 79
 - Importing, 79, 129
 - Certificates, 79
 - Changing
 - Brightness, 99
 - User data, 206, 207
 - Character repeat, 79
 - Screen keyboard, 89
 - Charge
 - Electrostatic, 263
 - Clamping frame, 24
 - Clean screen, 248
 - Clearance
 - MP 277, 43
 - Climatic
 - Shipping conditions, 37
 - Storage conditions, 37
 - Closing
 - Project, 208
 - Column sequence
 - Alarm view, 213
 - Compatibility conflict, 146
 - Computer name
 - Setting, 80
 - Condensation, 37
 - Conductor cross-section, 53
 - Equipotential bonding, 51
 - Configuration graphic
 - Configuration PC, 58
 - Controller, 55
 - Equipotential bonding, 52
 - Power supply, 53
 - Printer, 62
 - Configuration PC
 - Configuration graphic, 58
 - Connecting, 58
 - Configuration phase, 137
 - Configure
 - Network, 120
 - Configuring
 - Data channel, 80, 115
 - Operating system, 73
 - PC/PPI cable, 59
 - RS-422/RS-485 interface, 57
 - Screen keyboard, 79, 88
 - Configuring PC, 137
 - Connecting
 - Configuration PC, 58
 - Controller, 55
 - Equipotential bonding, 51
 - Mains terminal, 54
 - Power supply, 53, 54
 - Printer, 62
 - PROFINET, 56, 58
 - USB device, 61
 - Connection, 29
 - Connection sequence, 49
 - Connections to PLCs
 - Number, 29
 - Contact person, 5
 - Control cabinet
 - Working on, 31
 - Control keys
 - Keyboard unit, 85
 - Control Panel
 - MPI, 113
 - Open, 79
 - Operating, 82, 84
 - Password protection, 75
 - PROFIBUS, 113
 - Screen keyboard, 82
 - Controller
 - Configuration graphic, 55
 - Configuring the interface, 57
 - Connecting, 55
 - Conventions, 4
 - Converter RS 422-RS 232, 23
 - Cookies, 128
 - Creating
 - Recipe data record, 227, 237
 - Users, 203
 - CTRL key, 87, 175
 - Currency, 80
 - Cursor key, 86, 174
- ## D
- Data channel
 - Configuring, 80, 115
 - Enabling, 115
 - Locking, 115
 - Data flow, 221
 - Date, 79
 - Entering, 172, 180
 - Setting, 95
 - Synchronizing, 96
 - Date format, 80, 97
 - Date/time properties, 79, 95
 - Deactivating
 - Password protection, 95

- Decimal, 168
 - Default gateway, 122
 - Degree of protection, 42
 - Protection against ingress of solid foreign bodies, 44
 - Protection against water, 44
 - Delay time
 - Setting, 80, 108
 - Delete
 - Certificate, 129
 - Recipe data record, 230, 239
 - Users, 208
 - Delete key, 86, 175
 - Device name
 - For network operation, 121
 - DHCP, 122
 - DIP switch
 - Setting, 57
 - Direct key, 164
 - Functional scope, 28
 - Direct keys
 - Assignment, 258
 - Display
 - Alarm, 212
 - MP 277 Key, 256
 - MP 277 Touch, 255
 - Display format, 178
 - Displaying
 - Certificate, 79
 - HMI device information, 80
 - Info text, 173, 181
 - Information on the MP 277, 106
 - UPS status, 80
 - Disposal, 5
 - Disturbance
 - Pulse-shaped, 35
 - Sinusoidal, 36
 - DNS, 122
 - DNS
 - Server, 120
 - Documentation
 - Additional, 5
 - Enclosed, 45
 - Double-click, 79
 - Setting, 91
 - Drop down list box
 - Open, 175
- E**
- EC Declaration of Conformity, 32
 - Editing
 - Alarm, 216
 - Recipe data record, 229, 238
 - Elbow adapter, 23
 - Electrical
 - Safe separation, 54
 - Electrical potential difference, 51
 - Electrostatic charge, 263
 - Element list, 223, 235
 - E-mail
 - Set, function overview, 80
 - Setting, 125
 - EMC directive, 32
 - Emission, 34, 36
 - Encryption, 128
 - END key, 86, 174
 - Enhanced recipe view, 222
 - Enter key, 86, 174
 - ENTER key, 86, 174
 - Entering
 - Alphanumerical value, 171, 179
 - Date, 172, 180
 - Key combination, 87, 175
 - Numerical value, 169, 178
 - Recipe data record, 244
 - Symbolic value, 172
 - Text box, 167
 - Time, 172, 180
 - Entry on the HMI device
 - By means of function key, 177
 - Using operating elements, 161
 - Environmental conditions
 - Climatic, 40
 - Mechanical, 39
 - Test, 40
 - Equipotential bonding
 - Cable, 52
 - Configuration graphic, 52
 - Connecting, 51
 - Requirements, 51
 - Equipotential bonding rail, 52
 - Error alarm
 - Acknowledge, 215
 - ESC key, 86, 175
 - ESD
 - Short description, 263
 - Ethernet settings
 - IP address, 122
 - Exporting
 - Recipe data record, 242
 - Extended alarm view, 213
 - Extended user view, 199
 - External
 - Keyboard, 81
 - Mouse, 81

F

- Feedback
 - Acoustic, 103, 163
 - Optical, 162
- Fixation, 22
- FM approval, 33
- Fn key, 87, 175
- Front view, 14, 16, 18, 20
- Function
 - Additional, 28
- Function key
 - Labeling, 69
- Function keys
 - Global assignment, 177
 - Local assignment, 177
- Function test, 64
- Functional scope
 - Alarm buffer, 26
 - ALARM_S, 26
 - Graphics list, 26
 - Info text, 28
 - Limit monitoring, 26
 - Log, 27
 - Messages, 26
 - Recipe, 27
 - Safety, 27
 - Scaling, 26
 - Screen, 26
 - Tag, 26
 - Text list, 26

G

- Gauge, 182
- Graphics list
 - Functional scope, 26
- Group acknowledgement, 175

H

- High frequency radiation, 31
- HMI device
 - Cold restart, 105
 - EMC-compatible installation, 35
 - Information, 80
 - Interfaces, 50
 - Restarting, 80
 - Shutting down, 64
 - Specifications, 255, 256
 - Switching on, 63
 - Testing, 63

- HMI Input Panel
 - Options, 88
- HOME key, 86, 174
- Home page
 - Internet, 126
- Host cable
 - Safety instruction, 60

I

- Identification, 124
- Importing
 - Certificate, 79, 129
 - Recipe data record, 243
- Inadvertent operation
 - Acoustic signal, 163
- Info text
 - Displaying, 173, 181
 - Functional scope, 28
- Information
 - Additional, 5
 - For the HMI device, 106
- Infotext
 - Key, 176
 - LED, 176, 214
- Initial startup, 137
- Input device
 - MP 277 Key, 257
 - MP 277 Touch, 255
- Input Panel, 79
- Installation as intended, 32
- Installing
 - Option, 140, 155, 157
- Instructions
 - General, 34
- Insulation test
 - Test voltage, 44
- Interfaces
 - MP 277, 50
 - Rated load, 61
- Internet
 - Home page, 126
 - Options, 79
 - Search engine, 126
 - Security settings, 79
 - Service, 5
 - Settings, 125
 - Settings, overview of functions, 80
- Internet options
 - Privacy, 128
- IP address
 - Ethernet, 122

K

Key

- ACK, 175
- ALT, 87, 175
- A-Z, 87, 175
- Backspace, 175
- Cancel, 86
- CTRL, 87, 175
- Cursor, 86, 174
- Delete, 86, 175
- END, 86, 174
- ENTER, 86, 174
- ESC, 86, 175
- Fn, 87, 175
- HOME, 86, 174
- Infotext, 176
- Scroll back, 86, 174
- Scroll forward, 86, 174
- SHIFT, 87, 175
- TAB, 86, 174
- Tabulator, 86

Key combination

- Entering, 87, 175

Key control, 174, 177

- Trend view, 188

Keyboard

- External, 81
- Safety instruction, 66

Keyboard properties, 79

Knowledge

- Required, 3

L

Labeling

- Approvals, 33
- EC Declaration of Conformity, 32
- Function key, 69

Labeling strips

- Attaching, 71
- Dimensions, 70
- Printing, 69

LAN connection, 79

Language switching

- Functional scope, 28

Layout

- Slider control, 184
- Sm@rtClient view, 193
- Trend view, 186

LED

- Infotext, 176, 214
- Memory information, 107

- System information, 107

LED ACK, 211

License key

- Transferring, 140, 159
- Transferring back, 140, 160

Limit monitoring

- Functional scope, 26

Limit test, 168

Limit value

- For password, 198
- For user, 198
- For user view, 198

Limit value test, 178

Loader, 73

- Operating, 74

Locking

- Operating element, 248

Log

- Functional scope, 27

Logoff

- Users, 201

Logoff time, 197

Logon

- Users, 200

Logon data, 124

M

Main dimensions

- MP 277 10" Touch, 252, 253
- MP 277 8" Key, 251
- MP 277 8" Touch, 249, 250

Mains terminal

- Connecting, 54

Maintenance, 247

Manual

- Production sequence, 245
- Transfer, 141

Mechanical

- Shipping conditions, 37
- Storage conditions, 37

Memory

- MP 277 Key, 257
- MP 277 Touch, 255

Memory card, 24

- First use, 131
- Inserting, 67
- Restoring file system, 98
- Unplug, 68

Memory information

- LED, 107

Memory management, 80, 136

Menu command
Simple recipe view, 236

Monitoring mode
Sm@rtClient view, 193

Mounting
EMC-compatible, 35
Mounting clamp, 47, 48

Mounting clamp, 22
Mounting, 47, 48

Mounting cut-out
Dimensions, 43
Preparing, 43

Mounting location, 42

Mounting position, 41

Mouse
External, 81

Mouse properties, 79

MP 277
Applications, 13
Clearance, 43
Displaying information, 106
Interfaces, 50
Mounting, 46
Operator control, 65
Switching on, 63
Testing, 63

MP 277 10" Key
Bottom view, 20
Front view, 20
Overall dimensions, 254
Rear view, 21
Side view, 20

MP 277 10" Touch
Bottom view, 18
Front view, 18
Main dimensions, 252, 253
Rear view, 19
Side view, 18

MP 277 8" Key
Bottom view, 16
Front view, 16
Main dimensions, 251
Rear view, 17
Side view, 16

MP 277 8" Touch
Bottom view, 14
Front view, 14
Main dimensions, 249, 250
Rear view, 15
Side view, 14

MP 277 Key
Specifications, 256

MPI
Setting, 80, 113
Multi-key operation, 162, 176
Multimedia card, 67

N

Name server, 122

Network
Configure, 120
Logon data, 79
Set up, 119
Setting, 122

Network & dial-up connections, 79

Network ID, 79

Network operation
Device name, 121
Options, 80, 125

Nominal voltage, 44

Non-isolated plant configuration, 54

Notice of protected rights, 4

Number format, 80, 97

Numerical
Key assignment, 87, 175
Screen keyboard, 167

Numerical value
Changing, 169, 178
Decimal places, 168
Display format, 178
Entering, 169, 178
Limit test, 168
Limit value test, 178

O

Office location, 5

Offline
Operating mode, 138
Recipe tag, 226
Test, 145

Online
Operating mode, 138
Recipe tag, 226
Test, 145

OP properties, 80
Device, 106
Memory monitoring, 136
Persistent storage, 98
Touch, 92

OPC server, 13, 28

Open
Control Panel, 79

- Drop down list box, 175
 - Selection list, 86
 - Operating
 - Control Panel, 82
 - Feedback, 162
 - Key, 174, 177
 - Loader, 74
 - Operating element, 174
 - Operator control, 86
 - Project, 161
 - Recipe screen, 227, 237
 - Slider control, 184
 - Switches, 183
 - Trend view, 187
 - With external keyboard, 162
 - With external mouse, 162
 - Operating element
 - Locking, 248
 - Operating, 174
 - Recipe view, 227
 - Simple recipe view, 235
 - Operating instructions
 - Purpose, 3
 - Scope, 3
 - Operating mode, 138
 - Changing, 138
 - Offline, 138
 - Online, 138
 - Transfer, 63, 138
 - Operating system
 - Configuring, 73
 - Safety instruction, 60
 - Update, 151
 - Update using ProSave, 154
 - Update using WinCC flexible, 153
 - Operation feedback, 162
 - Operator control
 - Memory card slot, 67
 - MP 277, 65
 - Operating, 86
 - Selecting, 86
 - Operator control options, 81
 - Optical feedback, 162
 - Option
 - Installing, 140, 155
 - Installing with ProSave, 157
 - Installing with WinCC flexible, 155
 - Removing, 140, 155
 - Removing with ProSave, 158
 - Removing with WinCC flexible, 156
 - Options, 28
 - Network operation, 80, 125
 - Overall dimensions
 - MP 277 10" Key, 254
- P**
- Password, 197
 - Backing up, 198
 - Restoring, 198
 - Specifying, 94
 - Password list, 197
 - Password properties, 80, 94
 - Password protection, 75, 80
 - Activate, 94
 - Deactivating, 95
 - Windows CE taskbar, 75
 - PC/PPI
 - Cable, 23
 - Configuring the cable, 59
 - Setting the adapter, 59
 - PELV, 54
 - Peripheral
 - Rated load, 61
 - Permission in remote control, 194
 - Permissions in remote control, 196
 - Plant configuration
 - Non-insolated, 54
 - PLC
 - Number of connectable, 29
 - Protocol, 29
 - Reading recipe data record, 232, 240
 - Transferring recipe data record, 234, 241
 - PLC_User, 206, 207, 208
 - Ports
 - MP 277 Key, 257
 - MP 277 Touch, 255
 - Power failure, 146
 - Power supply
 - Configuration graphic, 53
 - Connecting, 53, 54
 - Printer
 - Configuration graphic, 62
 - Connecting, 62
 - Setting properties, 80
 - Printer connection
 - Setting, 102
 - Printer properties, 80, 102
 - Printing
 - Labeling strips, 69
 - Via network printer, 120
 - Process control phase, 137
 - Production sequence
 - Manual, 245

- PROFIBUS
 - Setting, 80
- PROFIBUS DP
 - Setting, 113
- PROFINET, 119
 - Addressing, 120
 - Connecting, 56, 58
- PROFINET IO
 - Disabling direct keys, 117
 - Enabling direct keys, 117
 - Releasing, 80
- Project
 - Closing, 208
 - in ProTool, 139
 - In WinCC flexible, 139
 - Offline testing, 145
 - Operating, 161
 - Reuse, 139
 - Testing online, 145
 - Transferring, 137, 140
- Protected trademark, 4
- Protection class, 44
- Protective foil, 23
- Protective measures
 - Static electricity, 264
- Protocol
 - PLC, 29
- Proxy
 - Server, 79, 125, 127
 - Setting, 79

- R**
- Radiation
 - High frequency, 31
- Radio interference, 34
 - Emission, 36
- Rated load
 - Interface, 61
- Reading out
 - Recipe data record, 232, 240
- Rear view, 15, 17, 19, 21
- Recipe, 218
 - Control, 219
 - Data flow, 221
 - Data record, 219
 - Field of application, 217
 - Functional scope, 27
 - Recipe screen, 222
 - Recipe view, 222
 - Synchronizing tags, 231
- Recipe data record
 - Creating, 227, 237
 - Delete, 230, 239
 - Editing, 229, 238
 - Entering, 244
 - Exporting, 242
 - Importing, 243
 - Reading from PLC, 232, 240
 - Synchronize with PLC, 229
 - Transferring to PLC, 234, 241
- Recipe list, 223, 235
- Recipe screen, 224
 - Operating, 227, 237
 - Overview, 224
- Recipe tag
 - Offline, 226
 - Online, 226
 - Synchronizing, 225, 231
- Recipe view, 222
 - Expanded, 222
 - Operating element, 227
 - Simple, 223
- Recommissioning, 137
- Record list, 223, 235
- Recycling, 5
- Regional and language settings, 80, 97
- Regional settings, 97
- Registered trademark, 4
- Registry information
 - Backing up, 80
- Registry Information
 - Backing up, 98
- Regulations for the prevention of accidents, 31
- Remote control
 - Forcing permission, 194, 196
 - Start, 194, 195
- Removing
 - Option, 140, 155, 156, 158
- Repairs, 248
- Reset to factory state, 140, 153, 154
- Restore, 79, 131
- Restoring, 140, 146, 148, 150, 198
 - from external storage device, 133
 - From memory card, 79, 98
 - With ProSave, 150
 - With WinCC flexible, 148
- Returns Center, 248
- Reverse polarity protection, 54
- RS-422/RS-485 interface
 - Configuring, 57
- Ruler
 - Trend view, 187

S

- S7 transfer settings, 80
 - Dialog, 113
- Safe electrical isolation, 54
- Safety
 - Functional scope, 27
 - Standards, 32
- Safety instruction
 - Backlighting, 100
 - Changed tag name, 231
 - Cold restart, 105
 - Compatibility conflict, 146
 - Compressed project file, 141
 - Damage to the HMI device, 49
 - Data channel, 152
 - Data loss, 131, 151
 - Direct key, 164
 - Electrostatic charge, 263
 - Equipotential bonding cable, 52
 - Grounding measures, 264
 - High frequency radiation, 31
 - Interface, 61
 - Keyboard, 66
 - License key, 146, 152, 155
 - Loss of data possible, 133
 - Memory card, first use, 68
 - Memory distribution, 107
 - Multi-key operation, 162
 - Path, 109
 - Power failure, 146
 - Preventing inadvertent operation, 247
 - Project file, 109
 - Recipe data record in background, 223
 - Remote control for channel 1, 115
 - Replacing the HMI device, 60
 - Storage, 37
 - Switching info text, 173, 181
 - Touch screen, 66
 - Transfer mode, 112, 117
 - Transfer mode channel 2, 117
 - Transport, 37
 - Unintentional action, 66, 176
 - Unintentional transfer mode, 116
 - Update operating system., 60
 - USB host-to-host cable, 60
 - Working on the control cabinet, 31
- Safety regulations, 31
- Scaling
 - Functional scope, 26
- Scheduler
 - Functional scope, 28
- Screen
 - Functional scope, 26
- Screen keyboard, 79, 166
 - Alphanumerical, 170
 - Change layout, 83
 - Character repeat, 89
 - Configuring, 88
 - For Control Panel, 82
 - Keyboard level, 170
 - Language switching, 170
 - Numeric, 167
 - Representation types, 83
- Screen saver, 101
 - Overview of functions, 80
 - Setting, 100
- Screen settings
 - Changing, 80
- Scroll back key, 86, 174
- Scroll forward key, 86, 174
- Search engine
 - Internet, 126
- Secure mode, 77
 - Cancel, 77
- Security settings, 79
- Security system, 197
- Selecting
 - Operator control, 86
- Selection list, 172, 180
 - Open, 86
- Service
 - In the Internet, 5
- Service pack, 24
- Set up
 - Network, 119
 - Secure mode, 77
- Setting
 - Backlighting, 80
 - Browser, 79
 - Computer name, 80
 - Date, 95
 - Date format, 97
 - Date/Time, 79
 - Delay time, 80, 108
 - DIP switch, 57
 - Double-click, 91
 - E-mail, 80
 - E-mail connection, 125
 - Language, 165
 - MPI, 80, 113
 - Network, 122
 - Number format, 97
 - PC/PPI adapter, 59
 - Printer connection, 102
 - Printer properties, 80

- PROFIBUS, 80, 113
- PROFINET IO, 80
- Proxy, 79
- Regional data, 97
- Screen saver, 100
- Time, 95
- Time format, 97
- UPS, 80, 109
- Volume, 80
- Setting language, 165
- Setting the time zone, 95
- Settings
 - Internet, 80
 - Language, 80
 - Regional, 80
 - S7-Transfer, 80
- Shift key, 87
- SHIFT key, 87, 175
- Shipping conditions, 37
- Shutting down
 - HMI device, 64
- Side view, 14, 16, 18, 20
- Siemens HMI input panel options, 79
- Simple alarm view, 212
- Simple recipe view, 223
 - Menu command, 236
 - Operating element, 235
- Simple user view, 199
- Slider control, 184
- Sm@rtAccess, 13, 28
- Sm@rtClient view, 193, 194
 - Monitoring mode, 193
 - Usage, 193
- Sm@rtService, 13, 28
- SMTP server, 125
- Software options, 28
- Sort order
 - Alarm view, 213
- Specifications
 - Display, 255, 256
 - Input device, 255, 257
 - Memory, 255, 257
 - MP 277 Key, 256
 - MP 277 Touch, 255, 256
 - Ports, 255, 257
 - Supply voltage, 256, 257
- Standard operating system, 13
- Start
 - HMI device, 105
- Static electricity
 - Protective measures, 264
- Status / control, 188
 - Key control, 191

- Status Force
 - Touch operation, 189
- Storage conditions, 37
- storage device
 - Restoring from external, 133
- Storage device
 - Saving to external, 131
- Strain relief, 64
- Subnet mask, 122
- Supply voltage
 - MP 277 Key, 257
 - MP 277 Touch, 256
- Switches, 183
- Switching on
 - MP 277, 63
- Symbolic value
 - Changing, 172
 - Entering, 172
- Synchronizing
 - Date and time, 96
 - Recipe tag, 225, 231
- System, 107
- System alarms
 - Parameters, 265
- System information, 80
 - LED, 107
- System properties, 80
 - Device name, 121
 - General, 107
 - Memory, 108

T

- TAB key, 86, 174
- Tabulator key, 86, 174
- Tag
 - Functional scope, 26
- TCP/IP address, 122
- Technical Support, 5
- Temporary files
 - Backing up, 98
- Test
 - For environmental conditions, 40
- Testing
 - MP 277, 63
- Text box, 167
 - Character mode, 174
 - Normal mode, 174
- Text list
 - Functional scope, 26
- Time, 79
 - Entering, 172, 180
 - Setting, 95

- Synchronizing, 96
- Time format, 80, 97
- Touch operation
 - Trend view, 187
- Touch screen
 - Calibrating, 80, 92
 - Safety instruction, 66
- Trademark, 4
- Training Center, 5
- Transfer, 137, 138, 141
 - Automatic, 142
 - Cancel, 63
 - Manual, 141
- Transfer mode
 - Unintentional, 116
 - Via MPI, 112
 - Via PROFIBUS DP, 112
- Transfer settings, 115
 - Channel, 115
 - Directories, 108
 - Overview of functions, 80
- Transferring
 - License key, 140, 159
 - Project, 137, 140
 - Recipe data record, 234, 241
- Transferring back
 - License key, 140, 160
- Transport damage, 45
- Trend view, 186
 - Key control, 188
 - Touch operation, 187
- Trends
 - Functional scope, 28
 - Limit violation, 186

U

- UL approval, 33
- Unintentional action, 66, 162
- Unintentional transfer mode, 116
- Update
 - Operating system, 151
- Update operating system., 140
- Updating
 - Using ProSave, 154
 - Using WinCC flexible, 153
- UPS
 - Displaying status, 80
 - Setting, 80, 109
- UPS properties
 - Configuration, 110
 - Current status, 111

- USB device
 - Connecting, 61
- Use
 - Conditions, 39
 - In residential areas, 34
 - Industrial, 34
 - With additional measures, 39
- User data
 - Backing up, 198
 - Changing, 206, 207
 - Restoring, 198
- User group, 197
- User name, 124
- User view, 198
 - Extended, 199
 - Simple, 199
- Users, 197
 - Admin, 206, 207, 208
 - Changing, 202
 - Creating, key control, 203
 - Delete, 208
 - Logoff, 201
 - Logon, 200
 - PLC_User, 206, 207, 208

V

- Value table
 - Trend view, 186
- VBScript
 - Functional scope, 28
- Volume, 103
 - Setting, 80
- Volume & Sounds Properties, 80

W

- Weight
 - MP 277 Key, 256
- Weight of the MP 277 Touch, 255
- WinCC flexible
 - Internet Settings, 80
- WinCC flexible internet settings
 - E-mail, 125
- Windows CE taskbar, 74
 - Password protection, 75
- WINS, 122
 - Server, 120
- Working on the control cabinet, 31

