

SIEMENS

SIMATIC HMI

HMI device
KTP400 Basic, KTP600 Basic,
KTP1000 Basic, TP1500 Basic

Operating Instructions

Preface

Overview

1

Safety instructions and
general notes

2

Mounting and connecting

3

Operating the user interface

4

Configuring the operating
system

5

Commissioning a project

6

Maintenance and care

7

Technical specifications

8

Appendix

A

Abbreviations

B

Legal information

Warning notice system

This manual contains notices you have to observe in order to ensure your personal safety, as well as to prevent damage to property. The notices referring to your personal safety are highlighted in the manual by a safety alert symbol, notices referring only to property damage have no safety alert symbol. These notices shown below are graded according to the degree of danger.

⚠ DANGER
indicates that death or severe personal injury will result if proper precautions are not taken.
⚠ WARNING
indicates that death or severe personal injury may result if proper precautions are not taken.
⚠ CAUTION
with a safety alert symbol, indicates that minor personal injury can result if proper precautions are not taken.
CAUTION
without a safety alert symbol, indicates that property damage can result if proper precautions are not taken.
NOTICE
indicates that an unintended result or situation can occur if the corresponding information is not taken into account.

If more than one degree of danger is present, the warning notice representing the highest degree of danger will be used. A notice warning of injury to persons with a safety alert symbol may also include a warning relating to property damage.

Qualified Personnel

The device/system may only be set up and used in conjunction with this documentation. Commissioning and operation of a device/system may only be performed by **qualified personnel**. Within the context of the safety notes in this documentation qualified persons are defined as persons who are authorized to commission, ground and label devices, systems and circuits in accordance with established safety practices and standards.

Proper use of Siemens products

Note the following:

⚠ WARNING
Siemens products may only be used for the applications described in the catalog and in the relevant technical documentation. If products and components from other manufacturers are used, these must be recommended or approved by Siemens. Proper transport, storage, installation, assembly, commissioning, operation and maintenance are required to ensure that the products operate safely and without any problems. The permissible ambient conditions must be adhered to. The information in the relevant documentation must be observed.

Trademarks

All names identified by ® are registered trademarks of the Siemens AG. The remaining trademarks in this publication may be trademarks whose use by third parties for their own purposes could violate the rights of the owner.

Disclaimer of Liability

We have reviewed the contents of this publication to ensure consistency with the hardware and software described. Since variance cannot be precluded entirely, we cannot guarantee full consistency. However, the information in this publication is reviewed regularly and any necessary corrections are included in subsequent editions.

Preface

Purpose of the operating instructions

These operating instructions provide information based on the requirements defined by IEC 62079 for documentation. This information relates to the HMI device, its storage, transportation, place of use, installation, use and maintenance.

These operating instructions are intended for a variety of target groups. The following table shows the sections of these operating instructions that are of particular importance for the respective target group.

Target group	Section
All	"Safety instructions"
Operators The operator operates and monitors the system during the process control phase.	"Overview" "Operating a project"
Commissioning engineers The commissioning engineer integrates the HMI device into the system and ensures the operating capability of the HMI device for the process control phase.	All sections. Depending on the use of the HMI device, certain chapters may not be of relevance to the commissioning engineer, e.g. the section "Maintenance and servicing."
Service technicians Service technicians rectify faults that occur during the process control phase.	All sections. Depending on the use of the HMI device, certain sections may not be of relevance to the service technicians, e.g. the section "Maintenance and servicing."
Maintenance technicians Maintenance technicians carry out servicing and maintenance work during the process control phase.	Maintenance and care

The help integrated in WinCC flexible, the WinCC flexible Information System, contains detailed information. The WinCC flexible Information System contains instructions, examples and reference information in electronic form.

Scope of the operating instructions

The operating instructions apply to the HMI devices KTP400 Basic, KTP600 Basic, KTP1000 Basic and TP1500 Basic in combination with the WinCC flexible software package.

Basic knowledge required

Knowledge of automation technology and process communication is necessary to understand the operating instructions.

An understanding of the use of computers and operating systems is also required.

Photos

Photographs are sometimes used to illustrate the HMI devices in these operating instructions. Newer versions of the products may differ from the photographs.

Conventions

The following graphical highlighting facilitates reading these operating instructions:

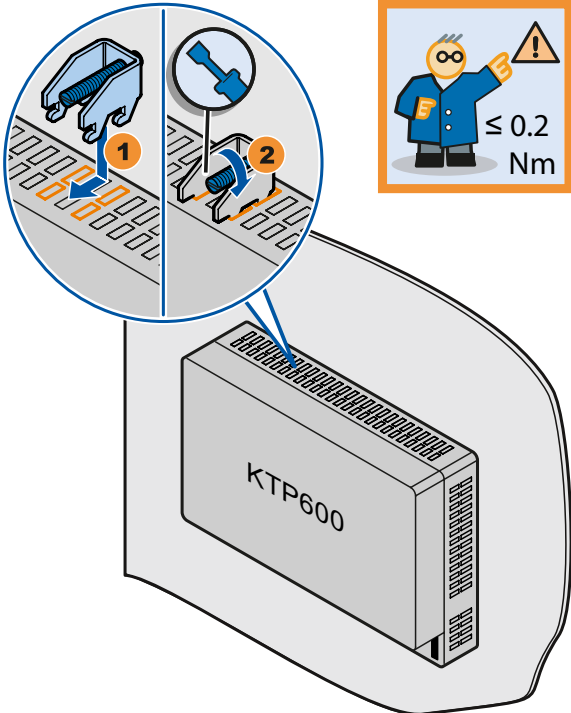
Graphical highlighting	Description
 <p>The diagram shows a KTP600 HMI device with a terminal block. Two callouts, labeled '1' and '2', show close-up views of the terminal block. Callout '1' shows a terminal being inserted into a slot, and callout '2' shows a terminal being secured with a screw. A light blue highlight is shown on the terminal block. An orange-bordered icon shows a person in a blue uniform pointing to a warning sign with the text '≤ 0.2 Nm'.</p>	<p>If the instructions involve several tasks, the individual tasks are highlighted by an orange number circle.</p> <p>A light blue highlight indicates components and tools that are required in the course of a task.</p> <p>Safety instructions are highlighted by an orange frame.</p> <p>KTP600 Basic as shown in the illustrations represents all HMI devices.</p>

The following text highlighting facilitates reading these operating instructions:

Text highlighting	Scope
"Add screen"	<ul style="list-style-type: none"> • Terms that appear in the user interface, for example, dialog names, tabs, buttons, menu commands • Input values, for example, limits, tag values • Path information
"File > Edit"	Operational sequences, for example, menu commands, shortcut menu commands
<F1>	Keyboard operation

Configuration and runtime software differ with regard to their names as follows:

- "WinCC flexible 2008", for example, refers to the configuration software.
The term "WinCC flexible" is used in a general context. The full name, for example, "WinCC flexible 2008", is always used when it is necessary to differentiate between different versions of the configuration software.
- "WinCC flexible Runtime" refers to the runtime software that can run on HMI devices.

Note information highlighted as follows:

Note

A note contains important information on described products and their handling or on a section of this documentation.

Trademarks

Names labeled with a ® symbol are registered trademarks of the Siemens AG. Other names used in this documentation may be trademarks, the use of which by third parties for their own purposes could violate the rights of the owner.

- HMI®
- SIMATIC®
- SIMATIC HMI®
- SIMATIC ProTool®
- WinCC®
- SIMATIC WinCC flexible®

Additional information

You can find additional information about products described in the manual under "Contact" in the following table:

Request	Contact
Contact persons and office locations	"http://www.siemens.com/automation/partner"
Additional technical documentation	"http://www.automation.siemens.com/portal/index.htm"
Training Center	"http://sitrain.automation.siemens.com/sitrain/"
Technical Support	"http://support.automation.siemens.com"
Online support request form	"http://www.siemens.com/automation/support-request"
Service	"http://www.siemens.com/automation/service"

Table of contents

	Preface	3
1	Overview	11
1.1	Product Overview.....	11
1.2	Design of the KTP400 Basic.....	12
1.3	Design of the KTP600 DP Basic.....	13
1.4	Design of the KTP600 PN Basic.....	14
1.5	Design of the KTP1000 DP Basic.....	15
1.6	Design of the KTP1000 PN Basic.....	16
1.7	Design of the TP1500 Basic	17
1.8	Product package	18
1.9	Accessories.....	19
1.10	Commissioning the HMI device	20
2	Safety instructions and general notes	21
2.1	Safety instructions.....	21
2.2	Notes about usage.....	22
3	Mounting and connecting	23
3.1	Preparations.....	23
3.1.1	Checking the package contents.....	23
3.1.2	Checking the operating conditions.....	23
3.1.3	Selecting a mounting position	24
3.1.4	Checking clearances.....	25
3.1.5	Making the mounting cut-out.....	25
3.1.6	Labeling the function keys	27
3.2	Mounting the HMI device	28
3.3	Connecting the HMI device.....	30
3.3.1	Connection sequence	30
3.3.2	Connecting the equipotential bonding circuit.....	32
3.3.3	Connecting the power supply.....	34
3.3.4	Connecting a programming device	35
3.3.5	Connecting the configuration PC	36
3.3.6	Connecting the PLC.....	39
3.4	Switching on and testing the HMI device.....	42
3.5	Securing the cables	43
4	Operating the user interface	45
4.1	Overview	45
4.2	General functions of the screen keyboard	47
4.3	Entering data on the KTP400 Basic.....	48
4.4	Entering data on the KTP600, KTP1000, TP1500 Basic.....	51

5	Configuring the operating system	53
5.1	Opening the Control Panel.....	53
5.2	Overview	54
5.3	Changing MPI/DP settings.....	55
5.4	Changing the network configuration	56
5.5	Changing monitor settings	57
5.6	Displaying information about the HMI device.....	58
5.7	Calibrating the touch screen	59
5.8	Displaying licensing information for the HMI device	60
5.9	Enabling a data channel.....	61
5.10	Changing password settings	63
5.11	Setting the Screen Saver	64
5.12	Setting acoustic signals.....	64
6	Commissioning a project	65
6.1	Overview	65
6.2	Operating modes.....	66
6.3	Data transmission options.....	67
6.4	Transfer	67
6.4.1	Overview	67
6.4.2	Starting manual transfer.....	67
6.4.3	Starting automatic transfer	68
6.4.4	Testing a project.....	69
6.5	Backup and restore	71
6.5.1	Overview	71
6.5.2	Backup and restore using WinCC flexible.....	72
6.5.3	Backup and restore using ProSave	74
6.6	OS update - Basic Panel DP.....	76
6.6.1	Overview	76
6.6.2	Resetting factory settings.....	77
6.6.3	Updating the Operating System using WinCC flexible	77
6.6.4	Updating the Operating System using ProSave	79
6.7	OS update - Basic Panel PN.....	80
6.7.1	Overview	80
6.7.2	Resetting factory settings.....	81
6.7.3	Updating the operating system using WinCC flexible.....	82
6.7.4	Updating the operating system using ProSave.....	83
6.7.5	Resetting to factory settings with WinCC flexible	84
6.7.6	Resetting to factory settings with ProSave	86
7	Maintenance and care	89
7.1	Maintenance and care.....	89
7.2	Recycling.....	90

8	Technical specifications	91
8.1	Standards, certificates and approvals	91
8.2	Electromagnetic compatibility	92
8.3	Transport and storage conditions	94
8.4	Conditions of use	95
8.5	Information on insulation tests, protection class and degree of protection	97
8.6	Power supply	98
8.7	Dimension drawings	99
8.7.1	Dimensional drawing of KTP400 Basic	99
8.7.2	Dimensional drawing of KTP600 DP Basic	100
8.7.3	Dimensional drawing of KTP600 PN Basic	101
8.7.4	Dimensional drawing of KTP1000 DP Basic	102
8.7.5	Dimensional drawing of KTP1000 PN Basic	103
8.7.6	Dimensional drawing of TP1500 Basic	104
8.8	Specifications	105
8.8.1	Specifications of the KTP400 Basic and KTP600 Basic	105
8.8.2	Specifications of the KTP1000 Basic and TP1500 Basic	107
8.9	Functional Scope with WinCC flexible	109
A	Appendix	111
A.1	ESD guideline	111
A.2	System events	113
B	Abbreviations	115
	Glossary	117
	Index	123

Overview

1.1 Product Overview

Focused on fundamentals - the new basic panels

Visualization is part of the standard repertoire for most machines these days. The cost factor plays a crucial role in this case, especially for small machines and simple applications. HMI devices with basic functions are often fully sufficient for simple applications .

This is exactly the demand we intend to fulfill – with our new SIMATIC Basic Panels. By focusing on fundamentals, the HMI devices of the Basic Line offers exactly those basic features that are demanded – and with the right economic conditions. A perfect cost-to-performance ratio.

As all devices in our product catalog, the new Basic Panels offer proven SIMATIC quality and – regardless of their display dimensions – numerous standard software functionality, for example, an alarm system, recipe management, trend functionality and language switching. Users therefore profit from the advantages of visualization, such as improved process quality, even with simple applications.

1.2 Design of the KTP400 Basic

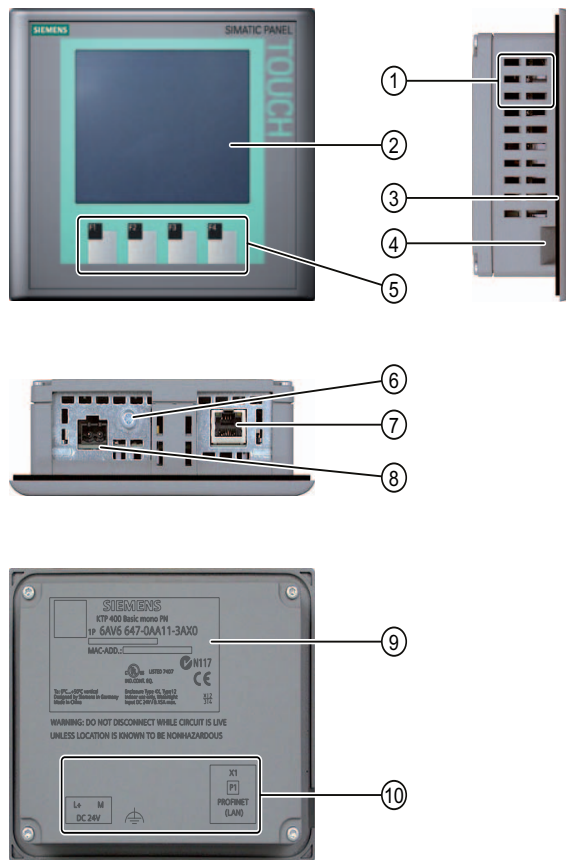

- ① Recesses for mounting clamps
- ② Display / touch screen
- ③ Mounting seal
- ④ Guide for labeling strips
- ⑤ Function keys

- ⑥ Connection for functional ground
- ⑦ PROFINET interface
- ⑧ Power supply connector
- ⑨ Rating plate
- ⑩ Interface name

1.3 Design of the KTP600 DP Basic

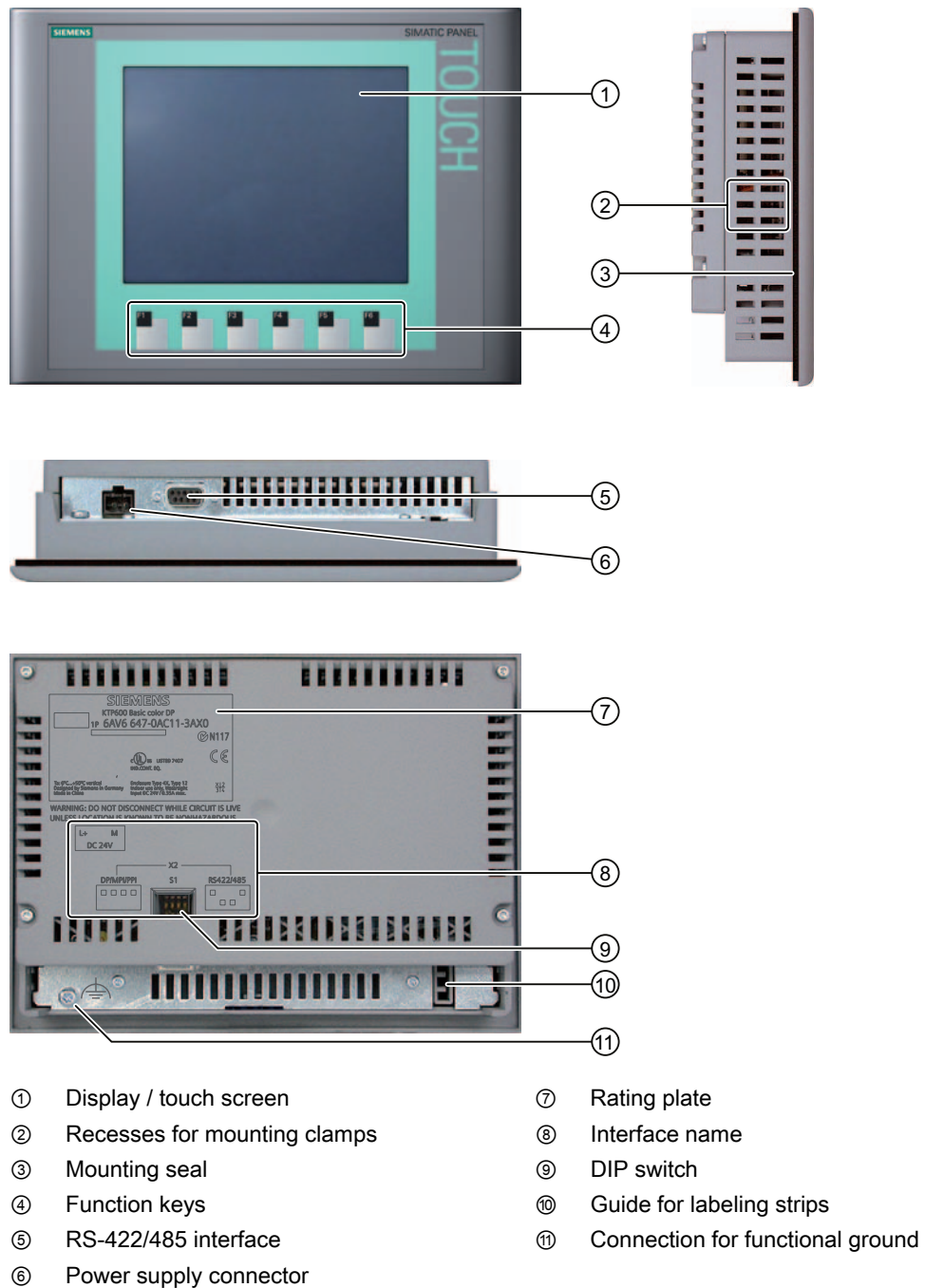

- | | |
|--------------------------------|------------------------------------|
| ① Display / touch screen | ⑦ Rating plate |
| ② Recesses for mounting clamps | ⑧ Interface name |
| ③ Mounting seal | ⑨ DIP switch |
| ④ Function keys | ⑩ Guide for labeling strips |
| ⑤ RS-422/485 interface | ⑪ Connection for functional ground |
| ⑥ Power supply connector | |

1.4 Design of the KTP600 PN Basic

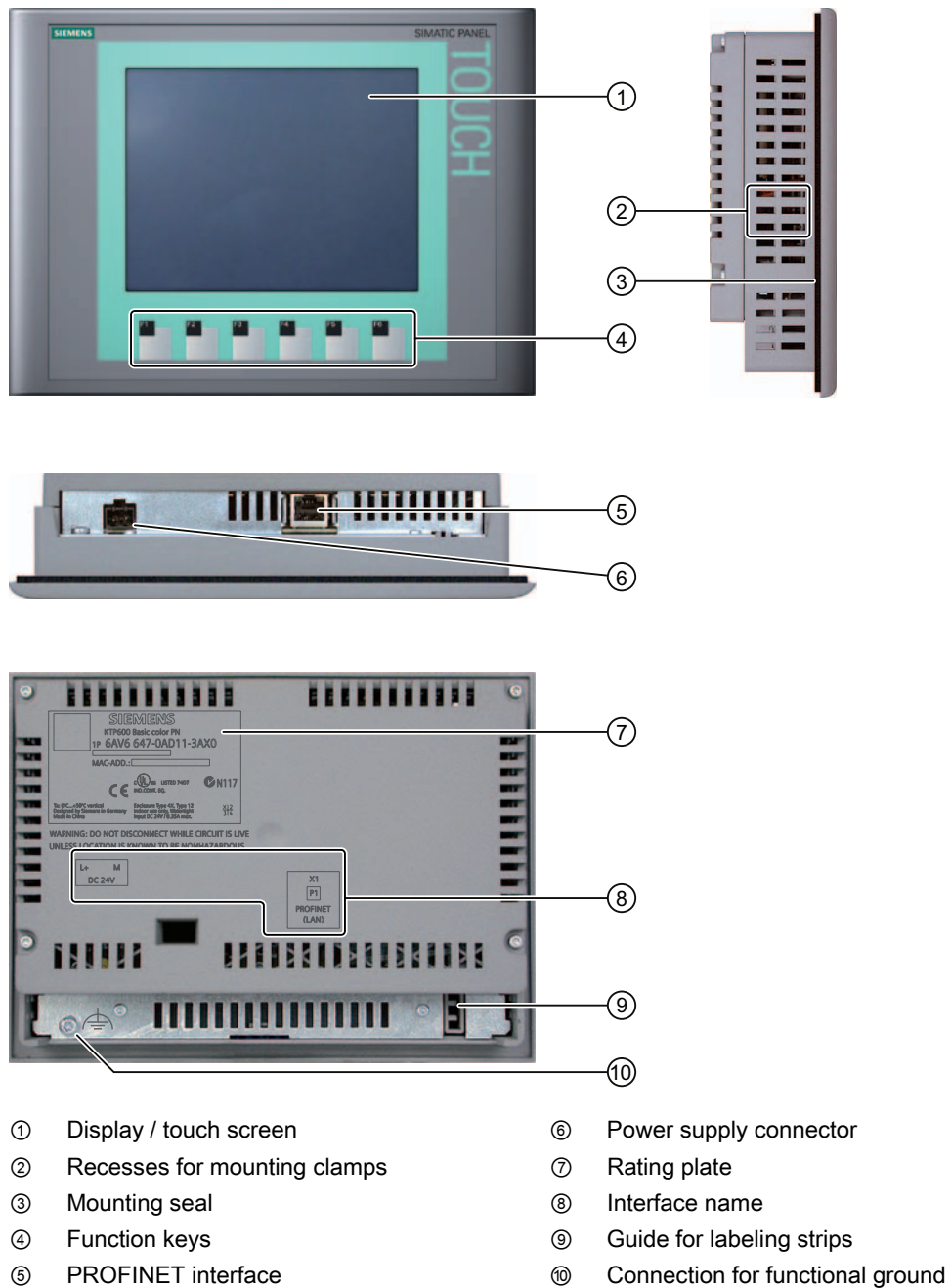

1.5 Design of the KTP1000 DP Basic

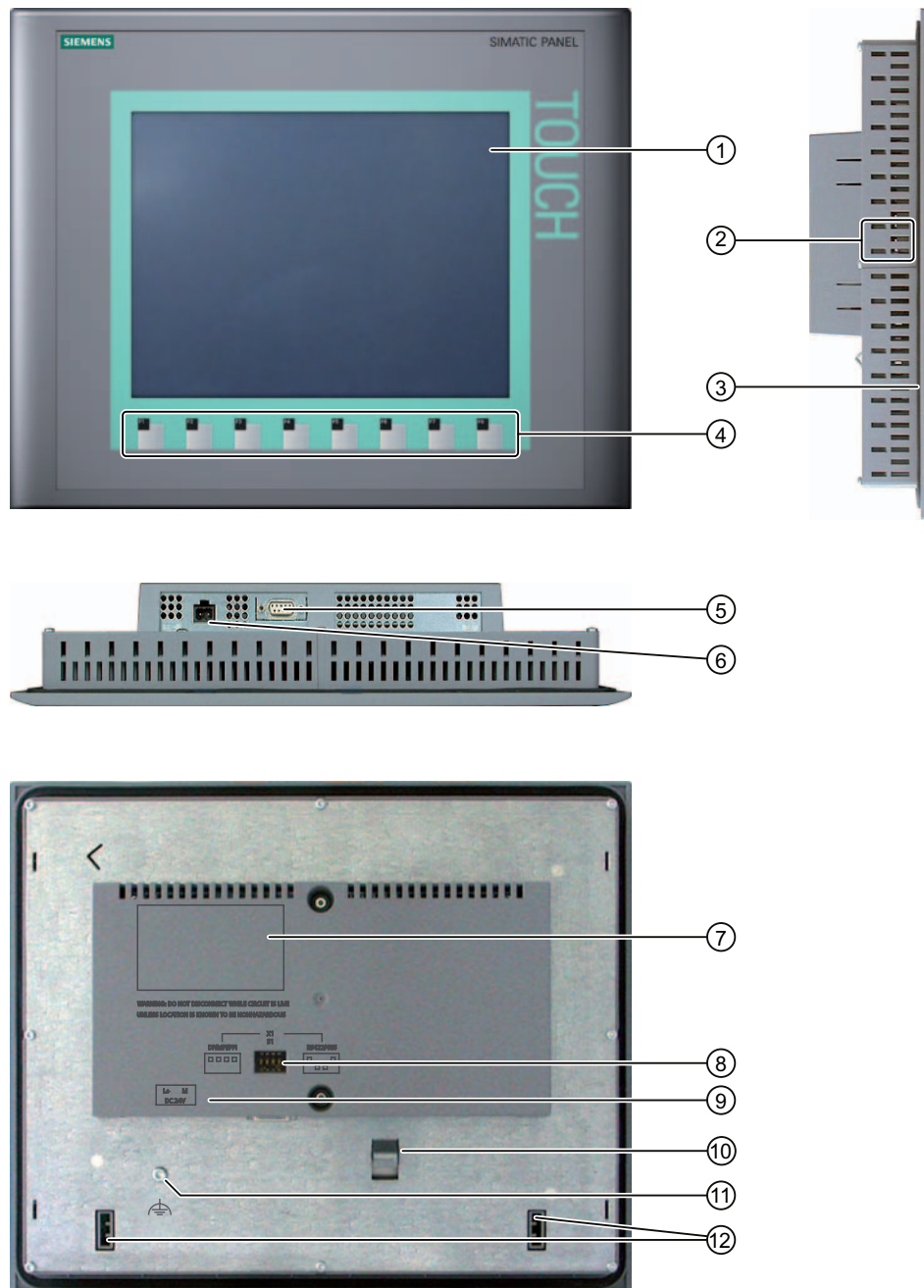

- | | |
|--------------------------------|------------------------------------|
| ① Display / touch screen | ⑦ Rating plate |
| ② Recesses for mounting clamps | ⑧ DIP switch |
| ③ Mounting seal | ⑨ Interface name |
| ④ Function keys | ⑩ Fixing element |
| ⑤ RS-422/485 interface | ⑪ Connection for functional ground |
| ⑥ Power supply connector | ⑫ Guides for labeling strips |

1.6 Design of the KTP1000 PN Basic

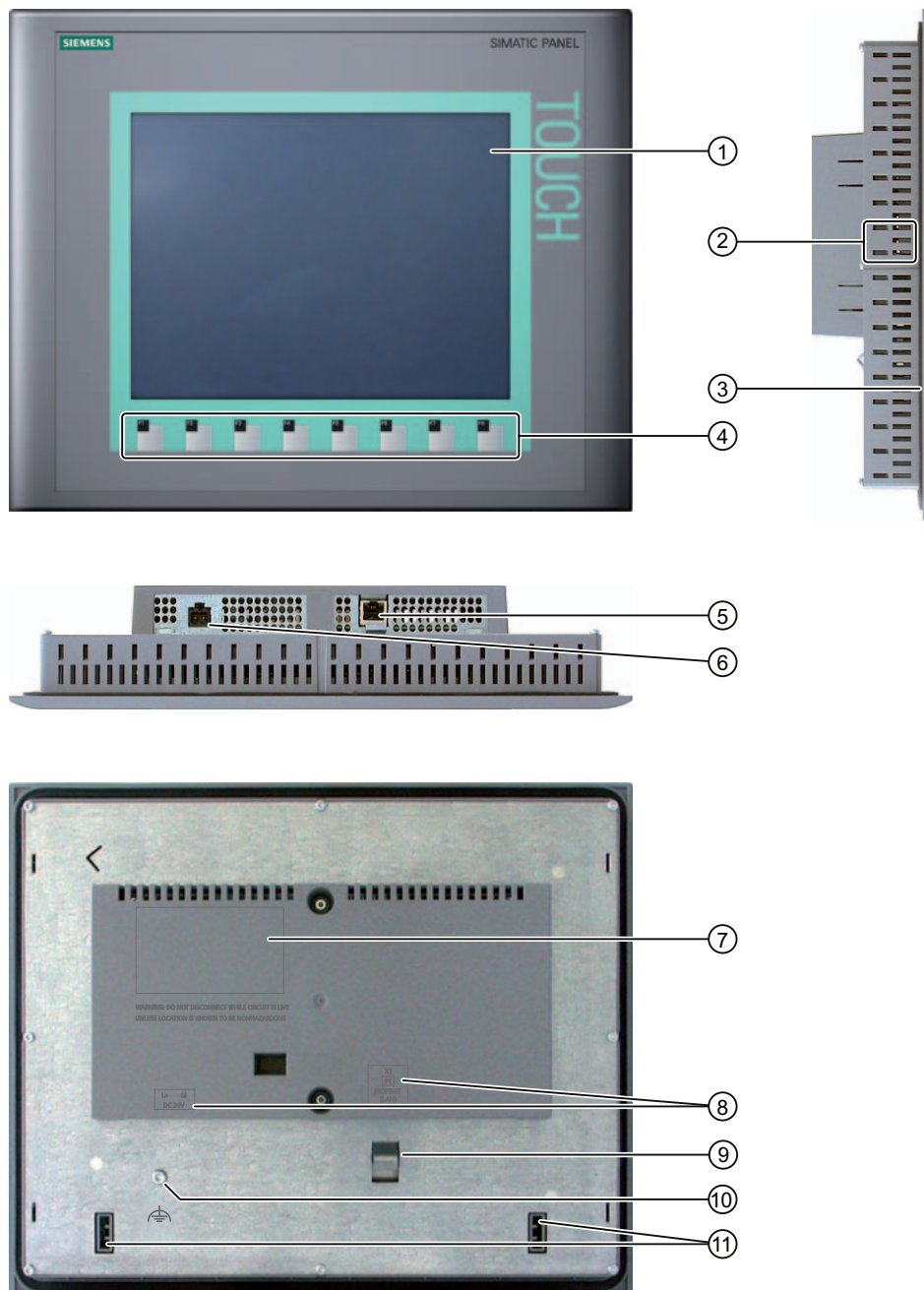

- | | |
|--------------------------------|------------------------------------|
| ① Display / touch screen | ⑦ Rating plate |
| ② Recesses for mounting clamps | ⑧ Interface name |
| ③ Mounting seal | ⑨ Fixing element |
| ④ Function keys | ⑩ Connection for functional ground |
| ⑤ PROFINET interface | ⑪ Guides for labeling strips |
| ⑥ Power supply connector | |

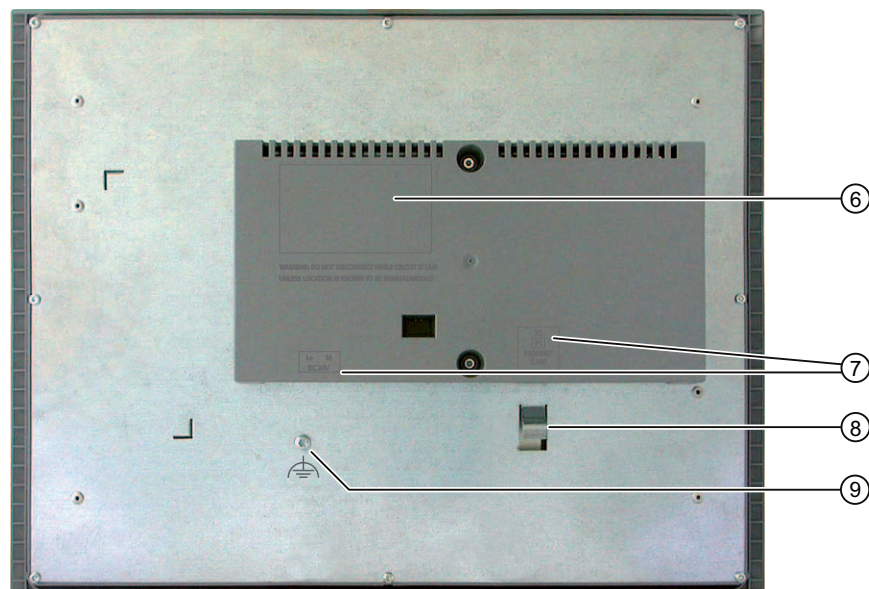
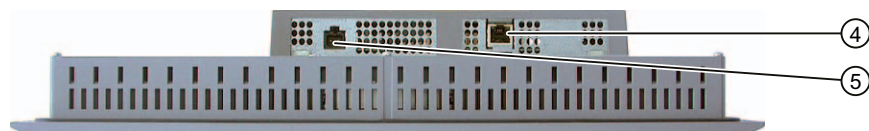
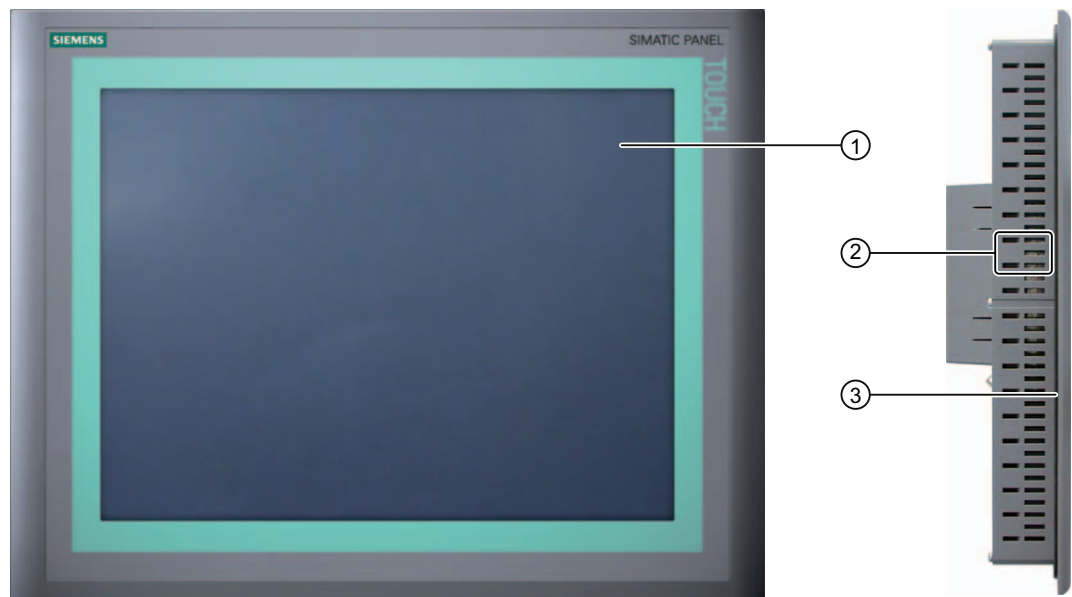

1.7 Design of the TP1500 Basic



- | | |
|--------------------------------|------------------------------------|
| ① Display / touch screen | ⑥ Rating plate |
| ② Recesses for mounting clamps | ⑦ Interface name |
| ③ Mounting seal | ⑧ Fixing element |
| ④ PROFINET interface | ⑨ Connection for functional ground |
| ⑤ Power supply connector | |

1.8 Product package

The following components are included in the product package of the HMI device.

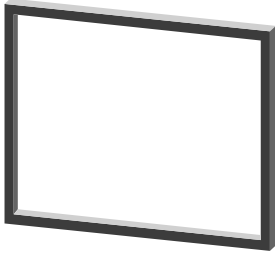
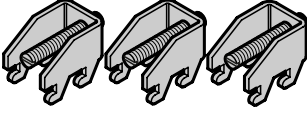
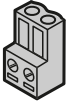
Name	Figure	Quantity	
HMI device		1	
Installation instructions		1	
Mounting seal		1 Enclosed with KTP 600 and already glued in with all other HMI devices.	
Clamps with stud bolts		5	KTP400 Basic
		6	KTP600 Basic
		12	KTP1000 Basic
		14	TP1500 Basic
Mains terminal		1	

1.9 Accessories

The following accessories are available for the HMI devices in the Internet at "<http://mall.automation.siemens.com>". The connector is not included in the scope of delivery of the HMI device.

RS 422 to RS 232 converter

The converter is required for the connection of controllers of other manufacturers to Basic Panels DP. Connect the RS 422 to RS 232 converter to the RS 422 / RS 485 interface. The converter converts the input signals to RS-232 signals.

Order no.: 6AV6 671-8XE00-0AX0

PC/PPI cable

You need the PC/PPI cable to update the operating system with reset to factory settings. You can also use the cable for data transfer. Connect the PC/PPI cable to the RS 422/485 port. The cable converts the input signals to RS-232 signals.

Order no.: 6ES7 901-3CB30-0XA0

Note

Set a lower bit rate if the connection is lost during the operating system update. If you use a higher bit rate, you must use the PC/PPI cable version 3 or higher. The version code is printed on the cable ("E stand 3," for example, corresponds to version 3).

USB/PPI cable

You need the USB/PPI cable to update the operating system with reset to factory settings. You can also use the cable for data transfer. Connect the USB/PPI cable to the RS 422/485 port. The cable converts the input signals to USB signals.

Order no.: 6ES7 901-3DB30-0XA0

90° elbow adapter

You can use an elbow adapter at the RS 422/RS 485 interface to cope with confined spaces.

Order no.: 6AV6 671-8XD00-0XA0

PROFIBUS bus connector

We recommend using straight PROFIBUS bus connectors.

Order no.: 6GK1 500-0FC10

PROFINET RJ45 plug connector

The connection of the Basic Panels PN to PROFINET requires the RJ45 plug connector "IE FC RJ45 Plug 2 x 2".

Order no.: 6GK1901-1BB10-2AA0

Clamping frame

A clamping frame is available to reinforce the mounting cutout in case the material is not strong enough for the KTP1000 HMI device.

Order no.: 6AV6 671-8XS00-0AX0

Protective foil

Protective foils are available for the HMI devices under the following order numbers:

- Protective foil for KTP400 Basic: 6AV6 671-2EC00-0AX0
- Protective foil for KTP600 Basic: 6AV6 671-2XC00-0AX0
- Protective foil for KTP1000 Basic: 6AV6 574-1AD00-4CX0
- Protective foil for KTP1500 Basic: 6AV6 574-1AD00-4EX0

1.10 Commissioning the HMI device

This section contains an overview of the tasks required for commissioning the HMI device.

	Description	Section
1.	Familiarize yourself with the safety instructions.	Safety instructions and general notes (Page 21)
2.	Prepare the HMI device for mounting.	Preparations (Page 23)
3.	Install the HMI device.	Mounting the HMI device (Page 28)
4.	Connect the equipotential bonding.	Connecting the equipotential bonding circuit (Page 32)
5.	Connect the power supply.	Connecting the power supply (Page 34)
6.	Connect a configuration PC.	Connecting the configuration PC (Page 36)
7.	Enable sharing for data channel on the HMI device.	Enabling a data channel (Page 61)
8.	Transfer a project.	Starting manual transfer (Page 67)
9.	After transferring the project, disconnect the HMI device from the configuration PC and connect the HMI device to the PLC.	Connecting the PLC (Page 39)

Safety instructions and general notes

2.1 Safety instructions

Working on the control cabinet

 WARNING
Open equipment The HMI device is open equipment. That is, the HMI device may only be installed in cubicles or cabinets which provide front panel access for operating the device. The cubicle or cabinet in which the HMI device is installed may only be accessed with a key or tool and only by trained, authorized personnel.
Dangerous voltage Opening the cabinet will expose high voltage parts. Contact with these parts could be fatal. Always disconnect the cabinet from the mains before opening it.

High frequency radiation

NOTICE
Unwanted operating states High-frequency radiation, for example, from cellular phones, can trigger unwanted operating states.

Installation as intended

 WARNING
Installation only in machinery that conforms to the machinery directive It is not allowed to commission the HMI device unless it has been verified that the machine in which the HMI device is to be installed complies with Directive 98/37/EC. The following applies as of December 29, 2009: The machine in which the HMI device is to be installed must conform to Directive 2006/42/EC.

2.2 Notes about usage

Industrial applications

The HMI device is designed for industrial applications. It conforms to the following standards:

- Requirements of the emission standard for industrial environments, EN 61000-6-4: 2007
- ESD immunity requirements to DIN EN 61000-6-2:2005

Use in residential areas

Note

The HMI device is not intended for use in residential areas. Operation of an HMI device in residential areas can have a negative influence on radio/TV reception.

If the HMI device is used in a residential area, you must take measures to achieve Limit Class B conforming to EN 55011 for RF interference.

A suitable measure for achieving the RF interference level to Limit Class B includes, for example, the use of filters in power supply lines

Individual acceptance is required.

Notes on communication

NOTICE
Communication errors caused by address conflict
Communication errors can occur if several devices in a network share the same bus address or IP address.
Make sure that your HMI device is assigned a unique address in the network.

Note

Updating tag values following a communication error

If communication between an HMI device and PLC is interrupted, all tag values displayed on the HMI device will be replaced by a hash mark ("#").

When the communication between the HMI device and PLC is restored, all tag values will be updated immediately. The cycle time for updating the tag values begins again at "0."

Ethernet communication with Basic Panels PN

Basic Panels PN support the following types of communication:

- PROFINET basic function for commissioning and diagnostics
 - Standard Ethernet communication
-

Mounting and connecting

3.1 Preparations

3.1.1 Checking the package contents

Check the package content for visible signs of transport damage and for completeness.

NOTICE
Damaged parts
Do not install parts damaged during shipment. In the case of damaged parts, contact your Siemens representative.

The package content is described in section Product package (Page 18).

Keep the supplied documentation in a safe place. The documentation belongs to the HMI device and is required for subsequent commissioning.

3.1.2 Checking the operating conditions



Note the following aspects before installing the HMI device:

1. Familiarize yourself with the standards, approvals, EMC parameters and technical specifications for operation of the HMI device. This information is available in the following chapters:
 - Standards, certificates and approvals (Page 91)
 - Electromagnetic compatibility (Page 92)
 - Information on insulation tests, protection class and degree of protection (Page 97)
 - Power supply (Page 98)
2. Check the mechanical and climatic ambient conditions for operation of the HMI device; see Conditions of use (Page 95).

3.1.3 Selecting a mounting position

Select one of the approved mounting positions for your HMI device. The approved mounting positions are described in the following sections.

Horizontal mounting positions

	<p>All Basic HMI devices are suitable for horizontal mounting positions.</p>
	<p>The following Basic HMI devices are also suitable for vertical mounting positions:</p> <ul style="list-style-type: none"> • KTP400 Basic • KTP600 Basic

Vertical mounting positions

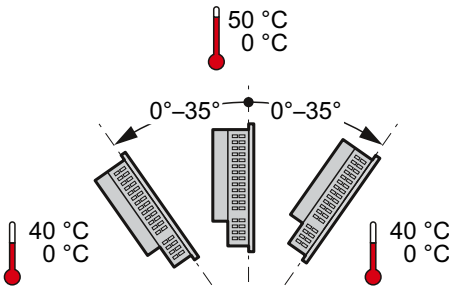
	<p>The Basic HMI devices are self-ventilating. Vertical and angled mounting is permitted in:</p> <ul style="list-style-type: none"> • Mounting cabinets • Control cabinets • Switchboards • Consoles
---	--

<p>⚠ CAUTION</p> <p>Exceeding the ambient temperature</p> <p>Forced ventilation is required if the maximum permitted ambient temperature for operating the HMI device is exceeded. The HMI device can otherwise be damaged and its approvals and warranty will be void.</p>

See also

Conditions of use (Page 95)

3.1.4 Checking clearances

The following clearances are required around the HMI device to ensure sufficient self-ventilation:

Required clearance around the HMI devices.
All dimensions in mm

	x	y	z
KTP400	15	40	10
KTP600	15	40	10
KTP1000	15	50	10
TP1500	15	50	10

3.1.5 Making the mounting cut-out

NOTICE

Stability of the mounting cut-out

The material in the area of the mounting cut-out must provide sufficient strength to guarantee the enduring and safe mounting of the HMI device.

The force of the clamps or operation of the device may not lead to deformation of the material in order to achieve the degrees of protection described below.

Degrees of protection

The degrees of protection of the HMI device can only be guaranteed if the following requirements are met:

- Material thickness at the mounting cut-out for IP65 degree of protection, or for enclosure type 4X/type 12 (indoor use only): 2 mm to 6 mm
- Permitted deviation from plane at the mounting cut-out: ≤ 0.5 mm
This condition must be fulfilled for the mounted HMI device.
- Permissible surface roughness in the area of the seal: ≤ 120 μm (R_z 120)

A clamping frame is additionally available for mounting the KTP1000 Basic to panels with a material thickness < 2 mm at the mounting cut-out. The frame enables you to achieve IP65 degree of protection or the protection class for enclosures type 4X/type 12.

Mounting compatibility

The mounting cut-outs of the Basic panels are compatible with the mounting cut-outs of the following SIMATIC HMI devices:

Mounting cut-out for the Basic Panel	Compatible to the mounting cut-outs of the HMI device
KTP400	TP 177B 4"
KTP600	TP 177 A, TP 177B 6", TP 177micro
KTP1000	MP 277 10" Touch, MP 377 12" Touch
TP1500	MP 377 15" Touch, Thin Client 15" Touch

Dimensions of the mounting cut-out

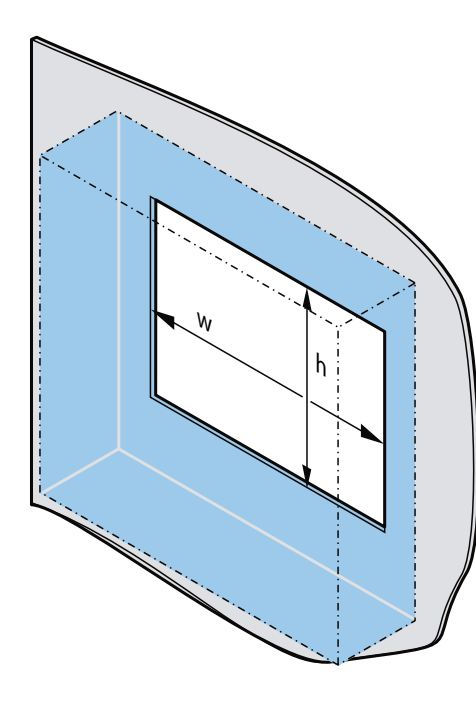

Dimensions of the mounting cut-out for the Basic HMI devices in horizontal mounting position:

	w_0^{+1}	h_0^{+1}
KTP400	123	99
KTP600	197	141
KTP1000	310	248
TP1500	367	289

Dimensions of the mounting cut-out for the Basic HMI devices in vertical mounting position:

	w_0^{+1}	h_0^{+1}
KTP400	99	123
KTP600	141	197

All dimensions in mm

See also

Accessories (Page 19)

3.1.6 Labeling the function keys

Note

Do not write on the keyboard to label the function keys.

Any printable and writable foil can be used as labeling strip. The permitted thickness of the labeling strip is 0.15 mm. Paper labeling strips are inappropriate.

	<ol style="list-style-type: none"> 1. Edit the template on the PC. The template is available in the CD_3\Documents\<language>\slides directory="" dvd.<="" flexible="" li="" on="" the="" wincc=""> 2. Print the edited template on foil. 3. Apply a fixing spray film to the labeling strips. 4. Wait approx. 5 minutes until the fixing spray is dry and smear-proof. 5. Cut out the labeling strip. 6. Cut off the corners of the labeling strips at an angle of 45° to make it easier to insert them. 7. Slide the labeling strips into the slot up to the end of the guide. </language>\slides> <p>The labeling strips will protrude approximately 3 cm out of the guide. The template dimensions for the labeling strips are designed so that the labeling is correctly placed for the function keys. It is not necessary to secure the labeling strip.</p>
--	---

3.2 Mounting the HMI device

Required tools and accessories

Before beginning mounting, have the following tools and accessories at hand:

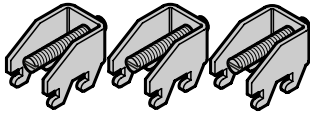
	Slotted screwdriver, size 2
	Mounting clamps <ul style="list-style-type: none"> • KTP400 Basic: 5 • KTP600 Basic: 6 • KTP1000 Basic: 12 • TP1500 Basic: 14

Inserting the HMI device

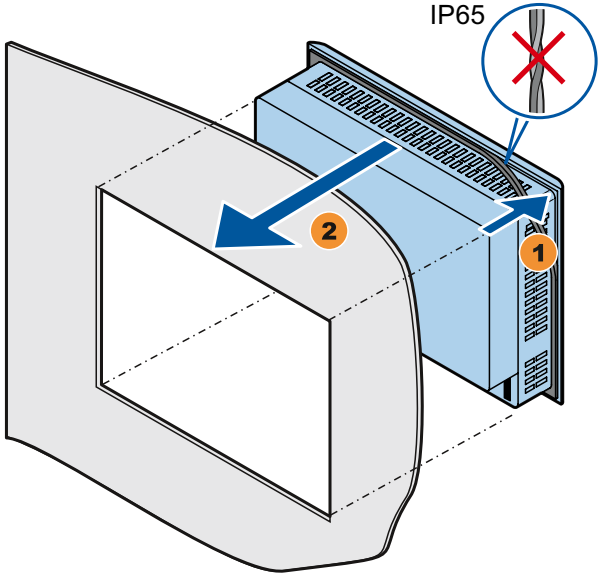
	<ol style="list-style-type: none"> 1. If necessary, insert the mounting seal in the groove on the back of the HMI device front panel. Ensure that the mounting seal is not twisted. A correctly inserted mounting seal is required to ensure IP65 degree of protection. 2. Insert the HMI device into the mounting cut-out from the front. Ensure that the protruding labeling strips are not caught between the mounting cut-out and HMI device.
---	---

Securing the HMI device

1. Insert the first clamp at the first position of the recesses on the back of the HMI device.

Set the clamp positions for your HMI device to match those of the figures in the following table row.

2. Secure the clamps using a size 2 screwdriver. The maximum permitted torque is 0.2 N/m.

3. Repeat steps 1 and 2 for all clamps required to secure your HMI device.

2-4 13-15
5-7
KTP400

3-5 24-26
2-4
14-16
KTP600

2-3 9-10 17-18 24-25
3-4
10-11
17-18
TP1500

2-3 11-12 20-21
2-3
9-10
16-17
KTP1000

3.3 Connecting the HMI device

3.3.1 Connection sequence

Required tools and accessories

Before beginning the connection of the HMI device, have the following tools and accessories at hand:

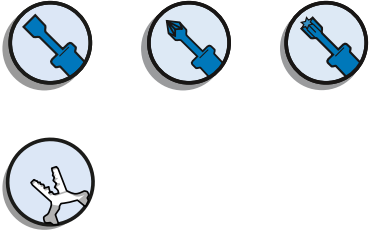
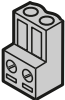
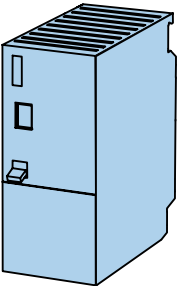
	<p>Screwdriver:</p> <ul style="list-style-type: none">• Slotted screwdriver, size 2• Philips screwdriver, size 3• Torx screwdriver size 3 <p>Crimp pliers</p>
	<p>Mains terminal</p>
	<p>24 VDC with sufficient amperage. See Specifications (Page 105)</p>

Procedure

Keep to the following sequence of tasks when connecting the HMI device:

1. Connecting the equipotential bonding circuit (Page 32)
2. Connecting the power supply (Page 34)
3. Connecting the configuration PC (Page 36)
4. Connecting the PLC (Page 39)

NOTICE
Strain relief Contacts can be broken or wires can be torn off if cables are not provided adequate strain relief. Provide adequate strain relief for all cables.

See also

Securing the cables (Page 43)

3.3.2 Connecting the equipotential bonding circuit

Differences in electrical potential

Differences in electrical potential can develop between spatially separated plant components. Such electrical potential differences can lead to high equalizing currents over the data cables and therefore to the destruction of their interfaces. Equalizing currents can develop if the cable shielding is terminated at both ends and grounded to different plant parts.

Differences in potential may develop when a system is connected to different mains supplies.

General requirements for equipotential bonding

Differences in potential must be reduced by means of equipotential bonding in order to ensure trouble-free operation of the relevant components of the electronic system. The following must therefore be observed when installing the equipotential bonding circuit:

- The effectiveness of equipotential bonding increases as the impedance of the equipotential bonding conductor decreases or as its cross-section increases.
- If two plant parts are interconnected by means of shielded data cables and their shielding is bonded at both ends to the grounding/protective conductor, the impedance of the additionally installed equipotential bonding cable must not exceed 10% of the shielding impedance.
- The cross-section of an equipotential bonding conductor must be capable of handling the maximum equalizing current. The best practical results for equipotential bonding between two cabinets have been achieved with a minimum conductor cross-section of 16 mm².
- Use equipotential bonding conductors made of copper or galvanized steel. Establish a large surface contact between the equipotential bonding conductors and the grounding/protective conductor and protect these from corrosion.
- Clamp the shielding of the data cable on the HMI device flush and near the equipotential rail using suitable cable clamps.
- Route the equipotential bonding conductor and data cables in parallel and with minimum clearance between these.

NOTICE
Equipotential bonding cable Cable shielding is not suitable for equipotential bonding. Always use the prescribed equipotential bonding conductors. The cross-section of the equipotential bonding conductor must not be less than 16 mm ² . Always use cables with an adequate cross-section when installing MPI and PROFIBUS DP networks. The interface modules may otherwise be damaged or destroyed.

Procedure

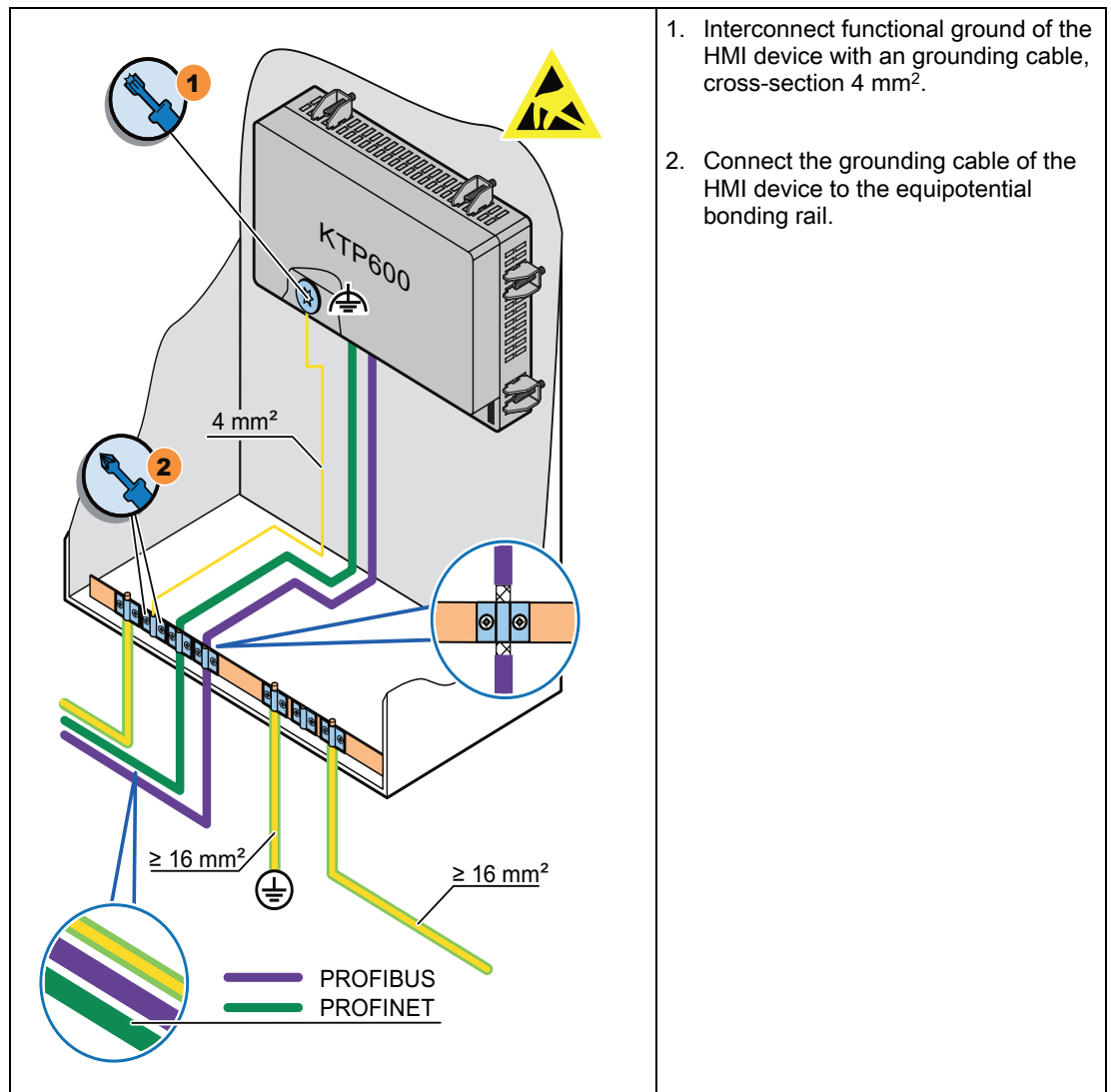

3.3.3 Connecting the power supply

Stripping the cable

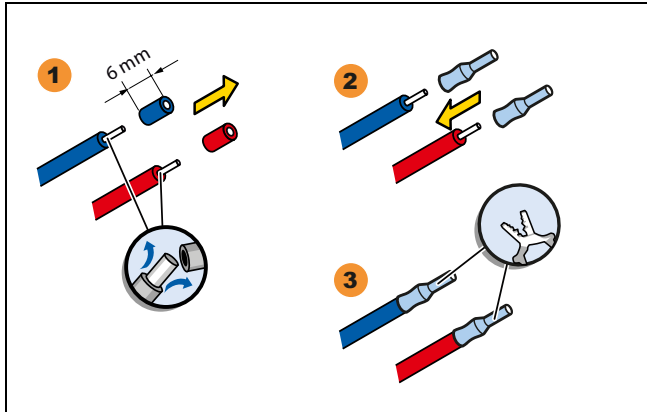
	<p>Use power supply cables with a maximum cross-section of 1.5 mm².</p> <ol style="list-style-type: none">1. Strip the ends of both power supply cables to a length of 6 mm.2. Insert the cable sleeve onto the bare cable ends.3. Fix the cable sleeve onto the cable ends using the crimp pliers.
---	--

Procedure

<p>CAUTION</p> <p>24 VDC only</p> <p>An incorrectly dimensioned power supply can lead to destruction of the HMI device.</p> <p>Use a 24 VDC power supply with adequate amperage; see Specifications (Page 105).</p>

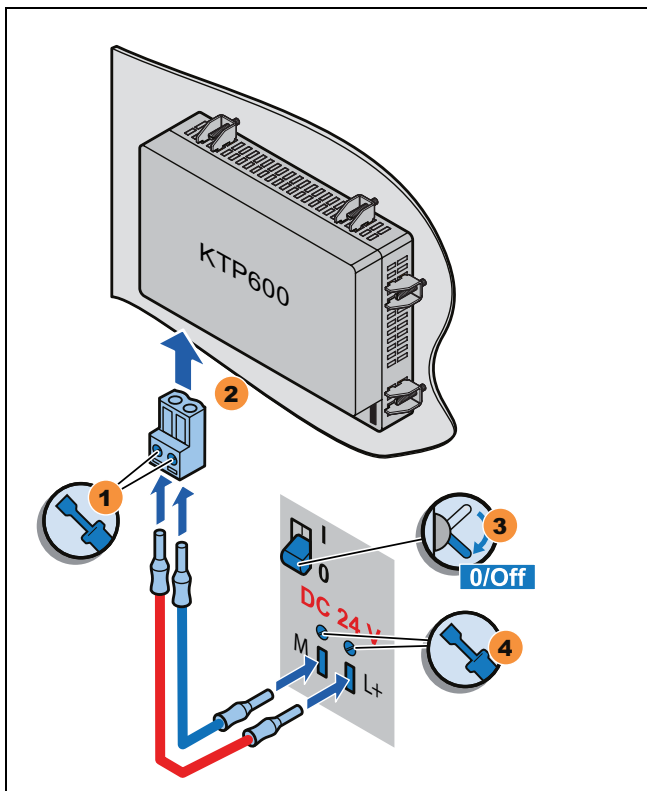
	<ol style="list-style-type: none">1. Insert the two power cables into the mains terminal and secure them with a slotted screwdriver.2. Connect the HMI device to the mains terminal.3. Switch off the power supply.4. Insert the two remaining cable ends into the power terminal and secure them with the slotted screwdriver. <p>Ensure correct polarity.</p>
---	--

3.3.4 Connecting a programming device

A programming device provides the following options:

- Transferring projects.
- Transferring device images.

Connecting a programming device to a Basic Panel DP

Note

A programming device cannot be used to reset the HMI device to factory settings.

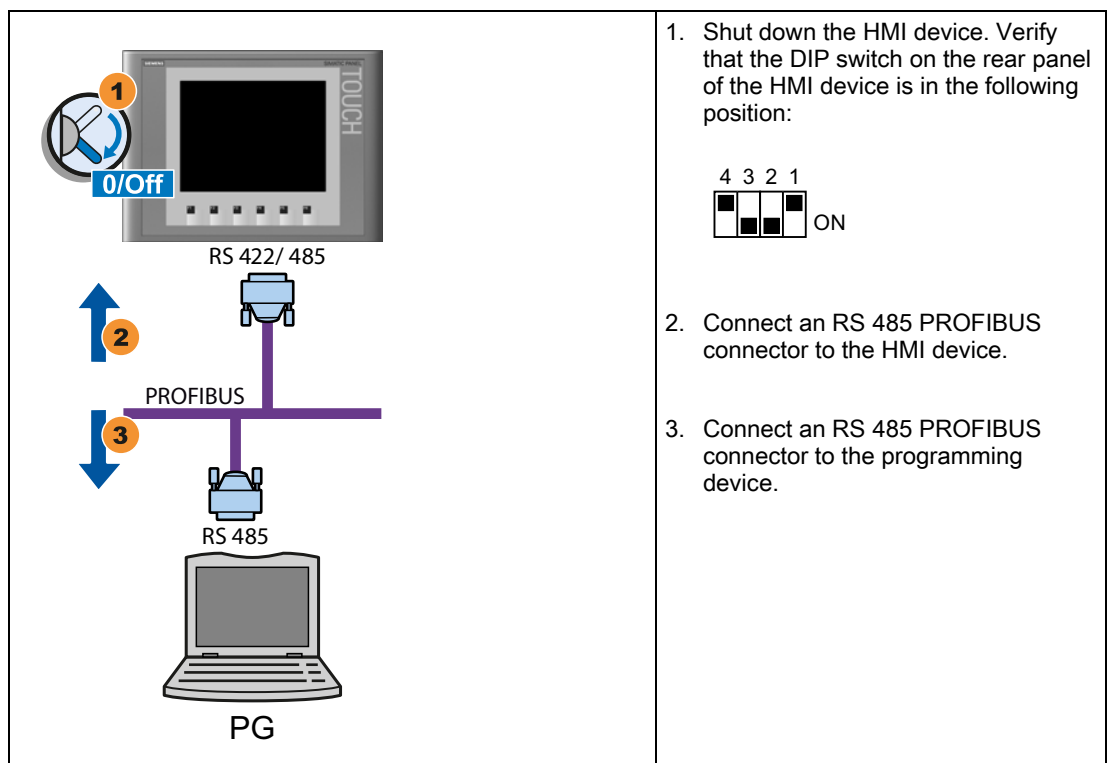

3.3.5 Connecting the configuration PC

A configuration PC provides the following options:

- Transferring projects.
- Transferring device images.
- Resetting HMI device to factory settings.

Connecting a configuration PC to a Basic Panel DP

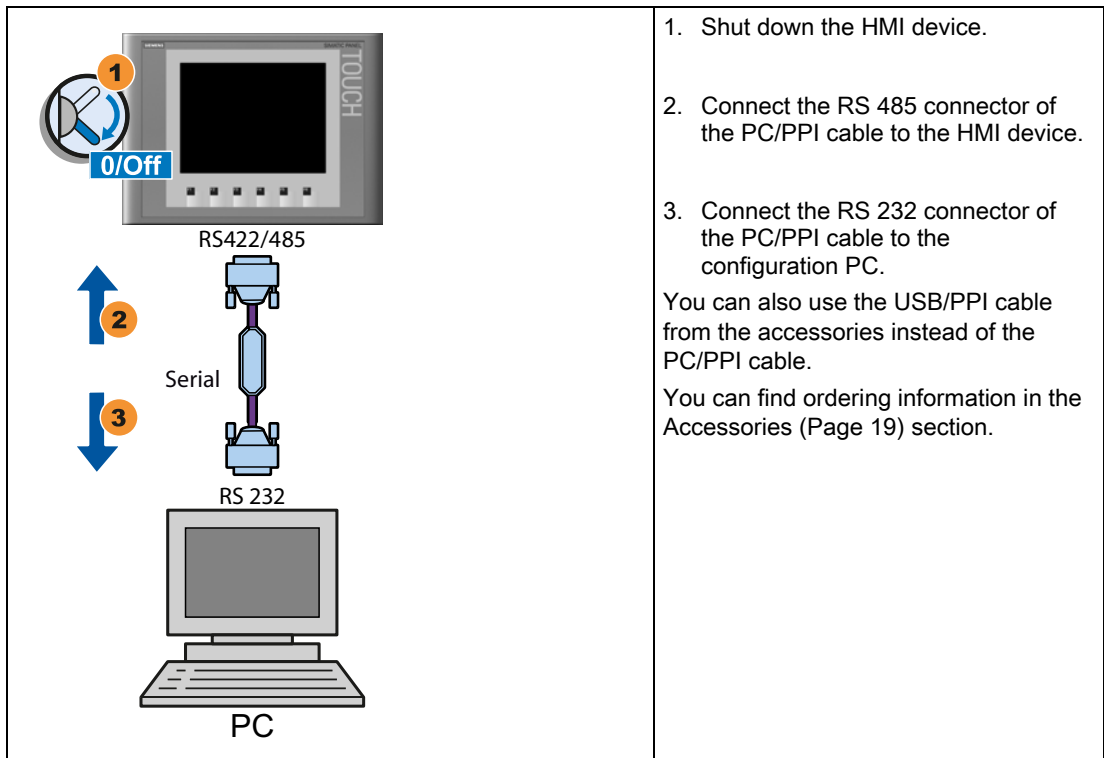

Configuring the PC/PPI cable

Configure the transmission speed using the DIP switches of the PC/PPI cable if using the PC/PPI cable to interconnect the HMI device with the configuration PC.

Note

Set a lower bit rate if the connection is lost during the operating system update. If you use a higher bit rate, you must use the PC/PPI cable release 3 or higher. The version code is printed on the cable ("E stand 3," for example, corresponds to version 3).



You can set the following bit rates:

Bit rate in kbps	DIP switch 1	DIP switch 2	DIP switch 3
115,2	1	1	0
57,6	1	1	1
38,4	0	0	0
19,2	0	0	1
9,6	0	1	0
4,8	0	1	1
2,4	1	0	0
1,2	1	0	1

Connecting a configuration PC to a Basic Panel PN

CAUTION

Data network security for communication via Ethernet

End users are themselves responsible for ensuring security of their data network in Ethernet-based communication, such as PROFINET, HTTP, Sm@rtAccess, Sm@rtService and OPC, since operation of the device cannot be guaranteed if the device is subject to targeted attacks resulting in overload, for example.

NOTICE

RJ45 plug connector with 180° output required

The connection of the Basic Panels PN to the HMI device requires the RJ45 plug connector "IE FC RJ45 Plug 2 x 2". You can find ordering information in the Accessories (Page 19) section.

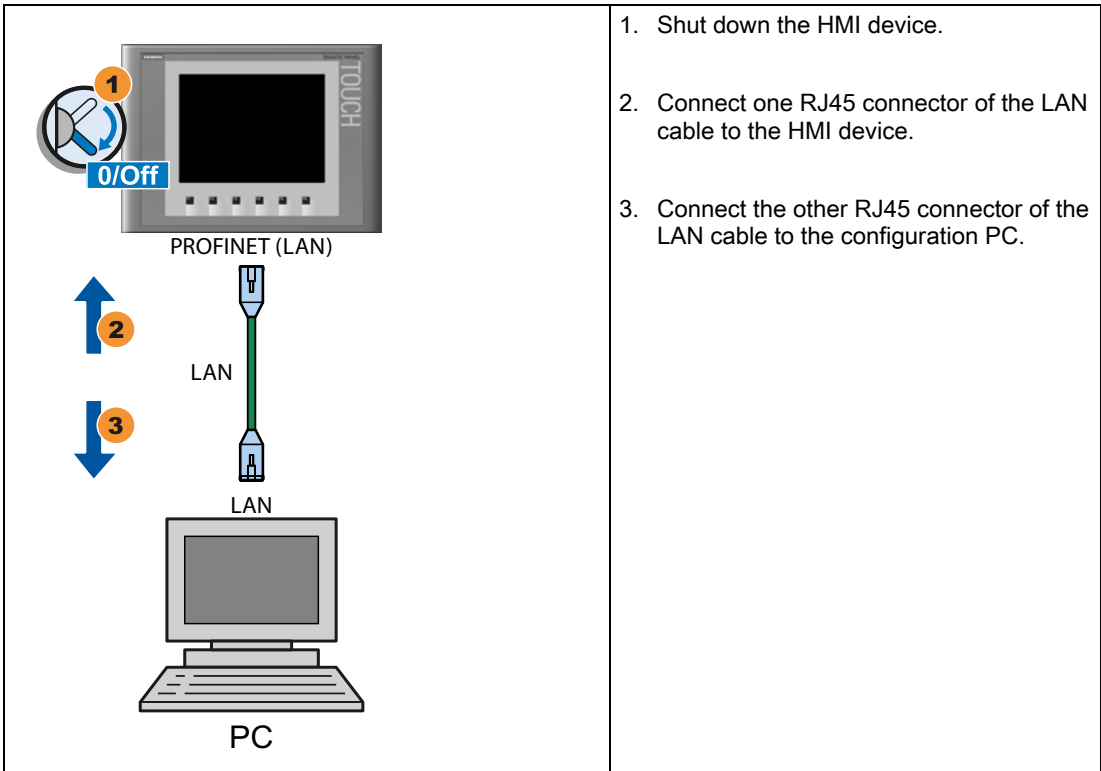

See also

Data transmission options (Page 67)

3.3.6 Connecting the PLC

Connect the HMI device to the PLC if it contains an operating system and an executable project.

Connecting a PLC to a Basic Panel DP

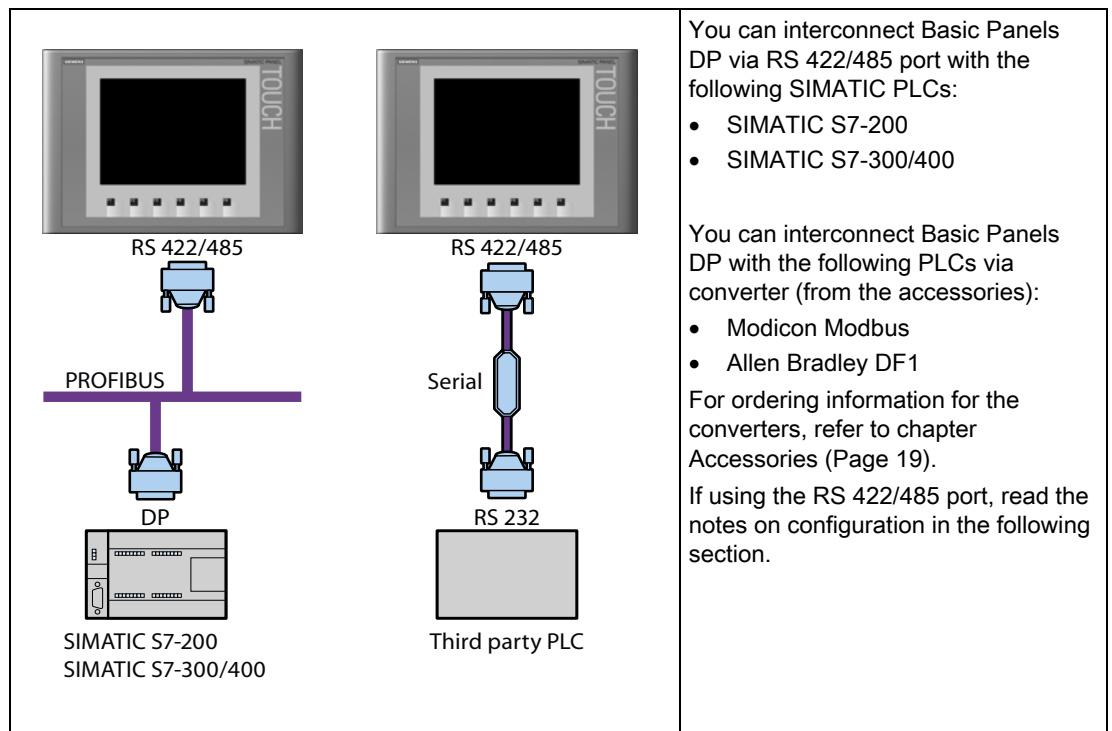

Configuring the RS-422/485 interface





The DIP switch for configuring the RS-422/485 interface is installed on the rear panel of the HMI device.

The DIP switch is set at the factory to enable communication with the SIMATIC PLC via RS 485.

Note

Note the diagrams of DIP switch settings on the rear panel of the HMI device.

The following table shows the DIP switch settings. The send and receive direction is toggled internally using the RTS signal.

Communication	Switch setting	Meaning
DP/MPI/PPI	<div style="display: flex; justify-content: space-around; width: 100px;"> 4321 </div> 	No RTS signal on connector, for data exchange between the SIMATIC PLC and the HMI device (factory state)
	<div style="display: flex; justify-content: space-around; width: 100px;"> 4321 </div> 	RTS signal on pin 4, same as PLC, for example, for commissioning
	<div style="display: flex; justify-content: space-around; width: 100px;"> 4321 </div> 	RTS signal on pin 9, same as for a programming device, for example, for commissioning
RS 422/485	<div style="display: flex; justify-content: space-around; width: 100px;"> 4321 </div> 	RS-422/485 interface is active, for example, for connecting PLCs of other manufacturers

Connecting the PLC to a Basic Panel PN

CAUTION

Data network security for communication via Ethernet

End users are themselves responsible for ensuring security of their data network in Ethernet-based communication, such as PROFINET, HTTP, Sm@rtAccess, Sm@rtService and OPC, since operation of the device cannot be guaranteed if the device is subject to targeted attacks resulting in overload, for example.

NOTICE

RJ45 plug connector with 180° output required

The connection of the Basic Panels PN to the HMI device requires the RJ45 plug connector "IE FC RJ45 Plug 2 x 2". You can find ordering information in the Accessories (Page 19) section.

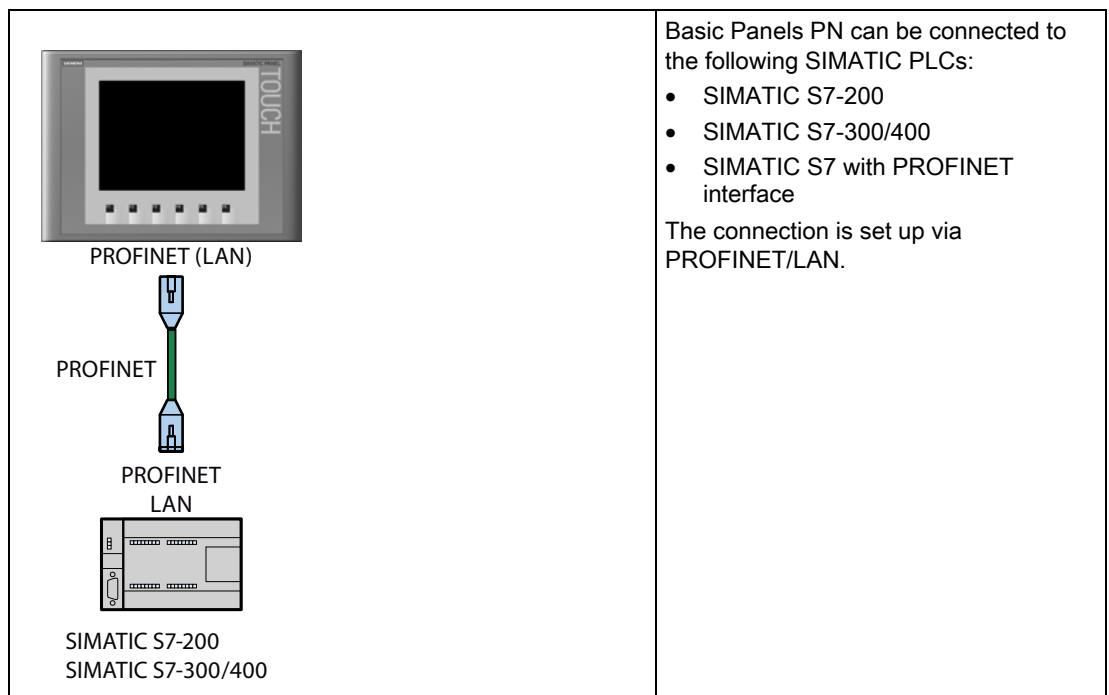

See also

Connecting the equipotential bonding circuit (Page 32)

3.4 Switching on and testing the HMI device

Switching on the HMI device.

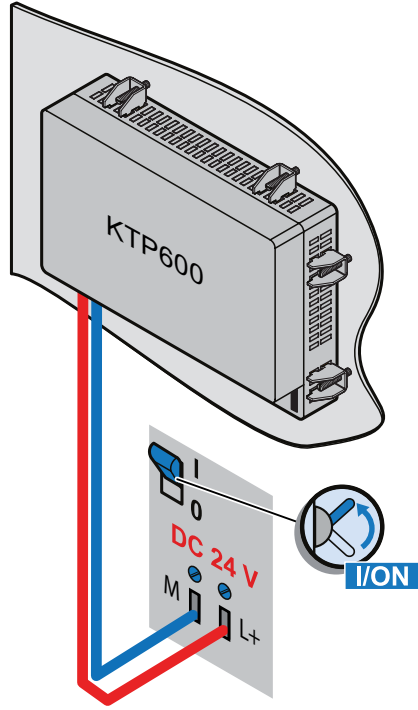
	<p>Switching on the power supply.</p> <p>The screen lights up after power is switched on. A progress bar is displayed during startup.</p> <p>If the HMI device fails to start, you have probably crossed the wires on the mains terminal. Check the connected wires and change their connection.</p>
--	--

The Loader opens after the operating system has started.

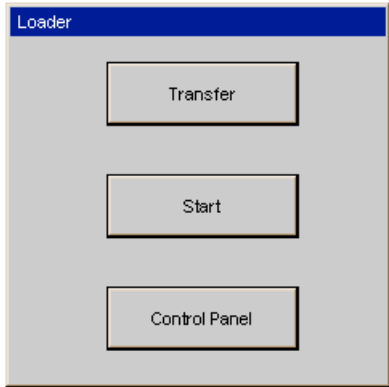
	<ul style="list-style-type: none">• Press the "Transfer" button to set the HMI device to "Transfer" mode. The transfer mode can only be activated when at least one data channel has been enabled for the transfer.• Press the "Start" button to start the project on the HMI device. If you do not perform an operation, the project on the HMI device is started automatically on expiration of a delay time.• Press the "Control Panel" button to open the Control Panel of the HMI device. You can make a variety of settings in the Control Panel, for example, the transfer settings.
---	---

Shutting down the HMI Device

1. Close any active projects on the HMI device.
2. Shut down the HMI device. You have the following shutdown options:
 - Switch off the power supply.
 - Remove the mains terminal from the HMI device.

3.5 Securing the cables

The following HMI devices come equipped with a fixing element on the back for strain relief:

- KTP1000 Basic DP
- KTP1000 Basic PN
- TP1500 Basic

After the power-on test, to ensure strain relief, use cable ties to secure the connected cables to the marked fixing element.

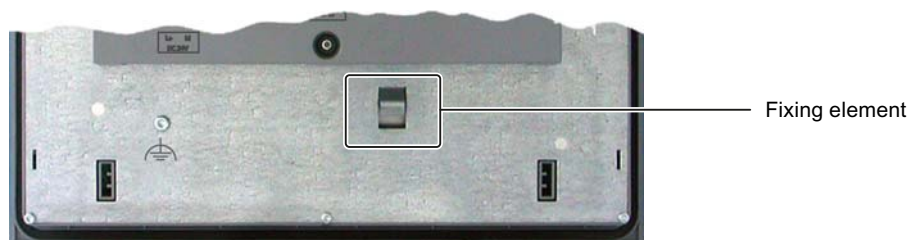

Operating the user interface

4.1 Overview

All Basic HMI devices feature a touch screen. Certain Basic HMI devices feature function keys. Use the touch screen and function keys to operate the Control Panel or the project running on your HMI device.

DANGER

Incorrect operation

A project can contain certain operations that require in-depth knowledge about the specific plant on the part of the operator.

Ensure that only trained professional personnel operate the plant.

Operating the touch screen

CAUTION

Damage to the touch screen

Pointed or sharp objects can damage the plastic surface of the touch screen.

Always operate the touch screen with your fingers or with a touch pen only.

Triggering unintended actions

Touching several operator controls at the same time can trigger unintended actions.

Touch only one operator control on the screen at a time.

Operator controls are touch-sensitive symbols on the screen of the HMI device.

They are basically operated in the same way as mechanical keys. You activate operator controls by touching them with your finger.

Note

The HMI device returns a visual feedback as soon as it detects that an operator control has been touched.

The visual feedback is independent of any communication with the PLC. The visual feedback signal therefore does not indicate whether or not the relevant action is actually executed.

Examples of operator controls:

- Buttons

Buttons can assume the following states:

"Untouched"



"Touched"



- Invisible buttons

The focus of invisible buttons is by default not indicated following selection. No optical operation feedback is provided in this case.

The configuration engineer may, however, configure invisible buttons so that their outline appears as lines when touched. This outline remains visible until you select another operator control.

- I/O fields

A screen keyboard appears as visual feedback after you touched an I/O field, for example, to enter a password.

Depending on the HMI device and the configured operator control, the system displays different screen keyboards for entering numerical or alphanumerical values.

The screen keyboard is automatically hidden again when input is complete.

Note

Description of all operator controls

A comprehensive description of all operator controls for your HMI device is provided in the WinCC flexible Online Help in the section "System alarms".

Operating function keys

The function keys can be assigned global or local functions:

- Function keys with global function assignment

A function key with global function assignment always triggers the same action on the HMI device or in the PLC, regardless of the currently displayed screen. An example of such an action is the activation of a screen, or the closing an alarm window.

- Function keys with local function assignment







A function key with local function assignment is screen-specific and is therefore only effective within the active screen.

The function assigned to a function key can vary from screen to screen.

The function key could be assigned only a single function within a screen only, that is, either a global or a local function. Local function assignments override global function assignments.

4.2 General functions of the screen keyboard

The following keys are available on the screen keyboard of all Basic HMI devices:

	Cursor left
	Cursor right
	Delete character
	Cancel input
	Confirm input
	Display infotext. This key only appears when an infotext has been configured for the operator control.



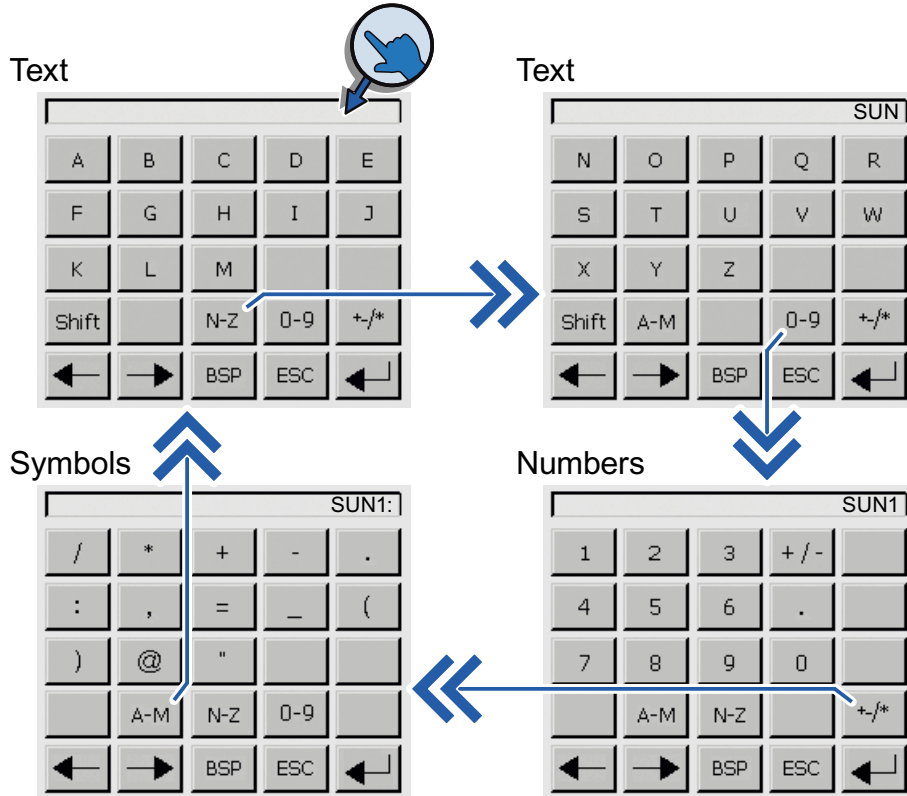

4.3 Entering data on the KTP400 Basic

Due to the small display, the screen keyboard and the input concept of the KTP400 Basic differs compared to other Basic HMI devices.



The screen keyboard appears on the HMI device touch screen when you touch an operator control that requires input.

The screen keyboard of the KTP400 features four views. You can change the view while making entries using the buttons in the fourth row of the screen keyboard:

Button	Changes to the view
	Entering text, characters "A" to "M"
	Entering text, characters "N" to "Z"
	Entering numbers, "0" to "9," signed or unsigned and with or without decimal places
	Entering special characters
	Entering text, shift to lower case letters

Note

Job mailbox has no effect

PLC job 51 "Select screen" has no effect while the screen keyboard is open.

Key assignment

The alphanumerical keyboard layout is monolingual.

A language change within the project does not have any effect on the layout of the alphanumerical screen keyboard.

Entering alphanumerical values

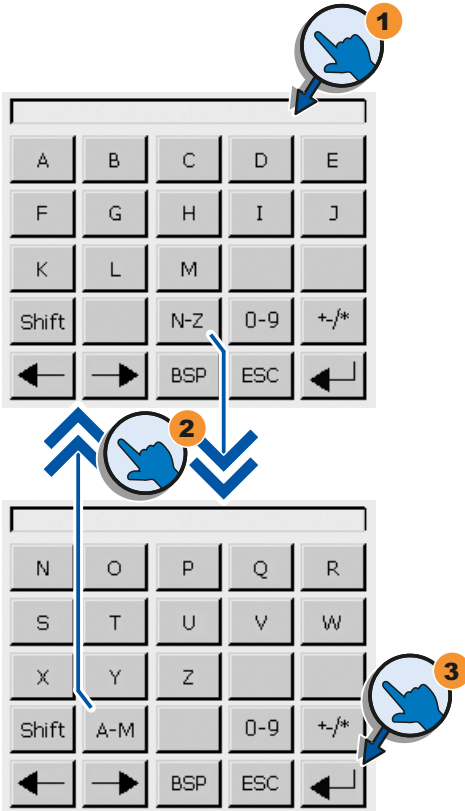

1. Touch the desired operator control on the screen.
The alphanumerical screen keyboard opens.

2. Enter the value. Depending on the settings, the HMI device outputs an audible signal.
You can change the view of the screen keyboard using the keys <N-Z> and <A-M>. Use the <Shift> key to enter lower-case letters.

3. Press <Return> key to confirm your entries, or cancel them with <ESC>. Either action closes the screen keyboard.

Entering numerical values

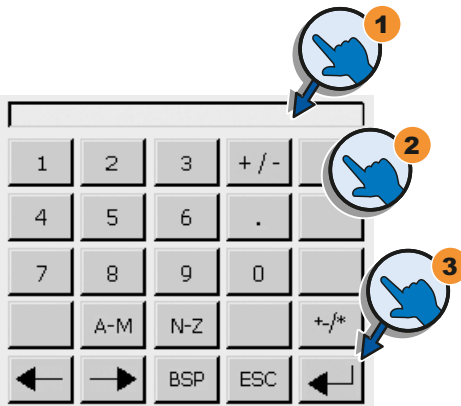
				
1	2	3	+ / -	
4	5	6	.	
7	8	9	0	
	A-M	N-Z	+/*	
←	→	BSP	ESC	↵

1. Touch the desired operator control on the screen.
The numerical screen keyboard opens.
2. Enter the value. Depending on the settings, the HMI device outputs an audible signal.
You can change the view of the screen keyboard for entering numbers with hexadecimal notation using the <N-Z> and <A-M> keys.
3. Press <Return> key to confirm your entries, or cancel them with <ESC>.
Either action closes the screen keyboard.

Checking numerical value limits

Tags can be assigned limit values. Any entry of a value outside this limit is rejected. If an alarm view is configured, a system event is triggered and the original value is displayed again.

Decimal places of numerical values

The configuration engineer can define the number of decimal places for a numerical text box. The number of decimal places is checked when you enter a value in this type of I/O field.

- Decimal places that exceed the limit are ignored.
- Unused decimal places are padded with "0" entries.

4.4 Entering data on the KTP600, KTP1000, TP1500 Basic

Alphanumerical screen keyboard

The screen keyboard appears on the HMI device touch screen when you touch an operator control that requires input.

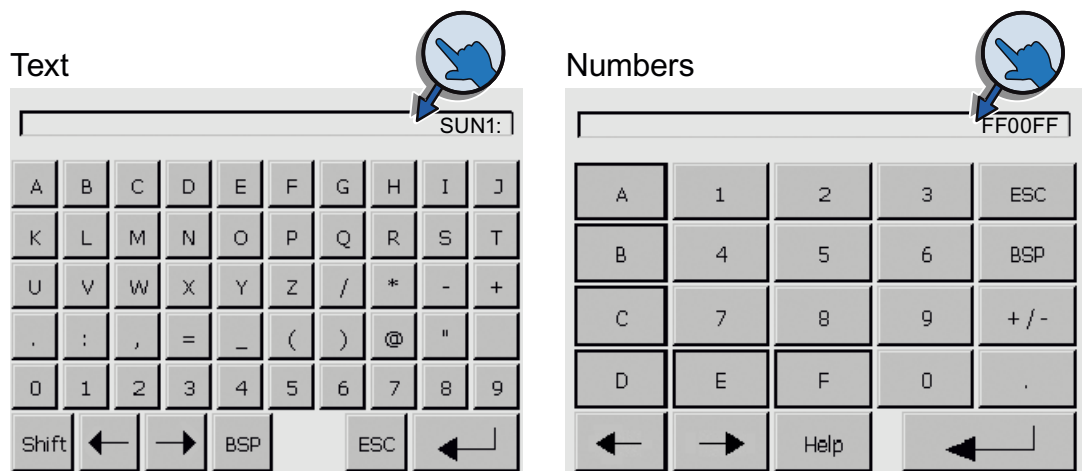

Note

Job mailbox has no effect

PLC job 51 "Select screen" has no effect while the screen keyboard is open.

Key assignment

The alphanumerical keyboard layout is monolingual.

A language change within the project does not have any effect on the layout of the alphanumerical screen keyboard.

Entering alphanumerical values

	<ol style="list-style-type: none"> 1. Touch the desired operator control on the screen. The alphanumerical screen keyboard opens. 2. Enter the value. Depending on the settings, the HMI device outputs an audible signal. Use the <Shift> key to enter lower-case letters. 3. Press <Return> key to confirm your entries, or cancel them with <ESC>. Either action closes the screen keyboard.
--	--

Entering numerical values

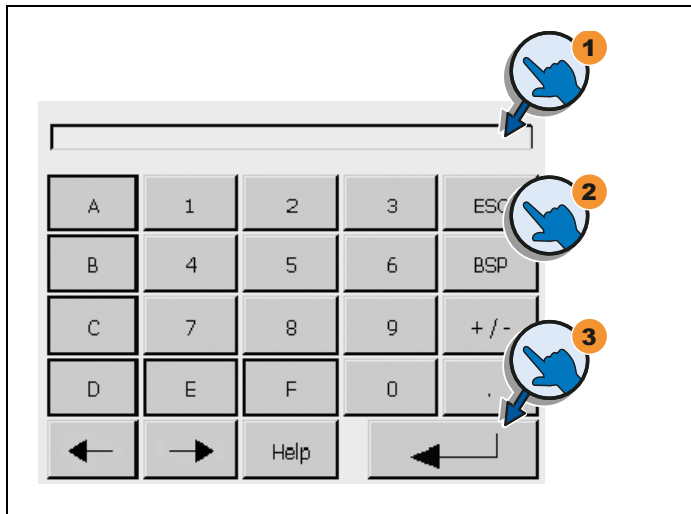

The diagram shows a numerical keypad with the following layout:

A	1	2	3	ESC
B	4	5	6	BSP
C	7	8	9	+ / -
D	E	F	0	.
←	→	Help	↩	

Callout 1 points to the top right corner of the keypad area. Callout 2 points to the 'ESC' key. Callout 3 points to the '↩' (Return) key.

1. Touch the desired operator control on the screen.
The numerical screen keyboard opens.
2. Enter the value. Depending on the settings, the HMI device outputs an audible signal.
3. Press <Return> key to confirm your entries, or cancel them with <ESC>.

Either action closes the screen keyboard.

Checking numerical value limits

Tags can be assigned limit values. Any entry of a value outside this limit is rejected. If an alarm view is configured, a system event is triggered and the original value is displayed again.

Decimal places of numerical values

The configuration engineer can define the number of decimal places for a numerical text box. The number of decimal places is checked when you enter a value in this type of I/O field.

- Decimal places that exceed the limit are ignored.
- Unused decimal places are padded with "0" entries.

Configuring the operating system

5.1 Opening the Control Panel

Open the Control Panel by pressing the "Control Panel" button of the Loader.

Configure your HMI device in the Control Panel. You can make the following settings:

- Communication settings
- Settings for operation
- Password protection
- Transfer settings
- Screen saver
- Acoustic signals

The "MPI / Profibus Settings" is only available on Basic Panels DP.

The "Profinet" is only available on Basic Panels PN.

Protecting the Control Panel with a password

You can protect the Control Panel against unauthorized operation. You can read the settings in the Control Panel without having entered a password, however, you are not allowed to edit the settings.

This prevents inadvertent operations and increases security for the plant or machine because the settings cannot be edited.









NOTICE

If the password is no longer available for the Control Panel, you first have to update the operating system before you can make any changes in the Control Panel.

All data on the HMI device is overwritten when you update the operating system!

5.2 Overview

The following table shows the functions available in the Control Panel for configuring your HMI device.

Symbol	Function
	Changing MPI/DP settings (Page 55)
	Changing the network configuration (Page 56)
	Changing monitor settings (Page 57)
	Displaying information about the HMI device (Page 58)
	Calibrating the touch screen (Page 59)
	Displaying licensing information for the HMI device (Page 60)
	Changing password settings (Page 63)
	Enabling a data channel (Page 61)
	Setting the Screen Saver (Page 64)
	Setting acoustic signals (Page 64)

5.3 Changing MPI/DP settings

Note

The settings for MPI or PROFIBUS DP communication are defined in the HMI device project. Edit the transfer settings only in the following situations:

- Initial transfer of a project.
- Changes made to the project are activated at a later time.

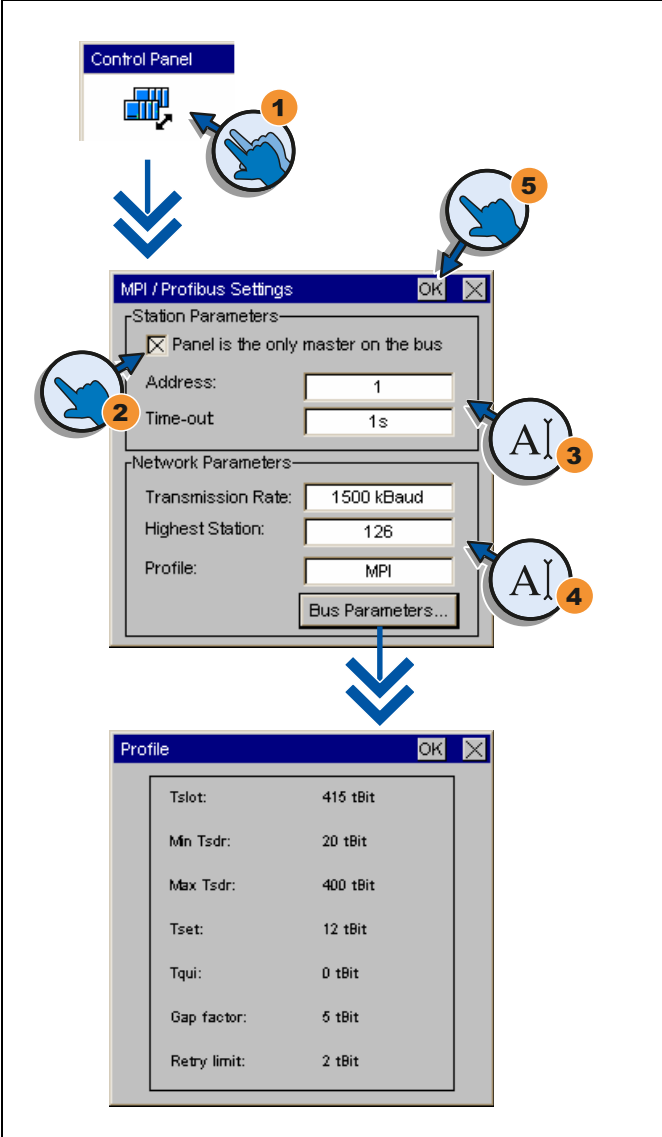

1. Press the "MPI / Profibus Settings" button to open the "MPI / Profibus Settings" dialog.

2. Deactivate the "Panel is the only master on the bus" check box if additional masters are connected to the bus.

3. Enter the bus address for the HMI device in the "Address" text box. The bus address must be unique within the MPI/PROFIBUS DP network.

Enter the time limit for PROFIBUS communication in the "Time-out" text box. Valid values are 1 s, 10 s and 100 s.

4. Select the transmission rate from the "Transmission Rate" text box.

Enter the highest station address on the bus in the "Highest Station" text box. Valid range of values: 1 to 126.

Select the profile from the "Profile" selection box.

Press the "Bus Parameters..." button to view the PROFIBUS profile data.

5. Close the dialog and save your entries with "OK".

5.4 Changing the network configuration

NOTICE

Communication errors caused by IP address conflicts

Communication errors can occur if several devices in a network share the same IP address.

Assign each HMI device an IP address that is unique within the network.

- Press the "Profinet" button to open the "Profinet Settings" dialog.
- Choose either automatic address assignment via DHCP, or user-specific address assignment.
- If assigning a user-specific address, use the screen keyboard to enter valid IP addresses in the "IP Address", "Subnet Mask" text boxes and if applicable in the "Default Gateway" text box.
- Change to the "Mode" tab.
- Enter the transmission rate for the PROFINET network in the "Speed" text box. Valid values are 10 Mbps and 100 Mbps.
- Select "Half duplex" or "Full duplex" as the connection mode.
- The following functions will be activated if the checkbox "Auto Negotiation" has been set:
 - Connection mode and transmission rate will be detected and set automatically in the PROFINET network.
 - The "Auto-Crossover" function will be activated, which means the HMI device can be connected to a PC or a controller without additional crossover cable.
- Change to the "Device" tab.
- Enter a network name for your HMI device. The name must meet the following conditions.
 - Maximum length: 240 characters
 - Special characters: only "-" and "."
 - Invalid syntax: "n.n.n.n" (n=0 to 999) and "port-xyz" (x, y, z =0 to 9)
- Close the dialog and save your entries with "OK".

5.5 Changing monitor settings

NOTICE

Orientation of the screen for KTP400 Basic and KTP600 Basic

The screen orientation is defined by the configuration engineer in the course of project creation. The appropriate screen orientation is set automatically when you transfer the project to the HMI device.

Do not make any changes to the screen orientation if a project exists on the HMI device. The screen content may otherwise be truncated.

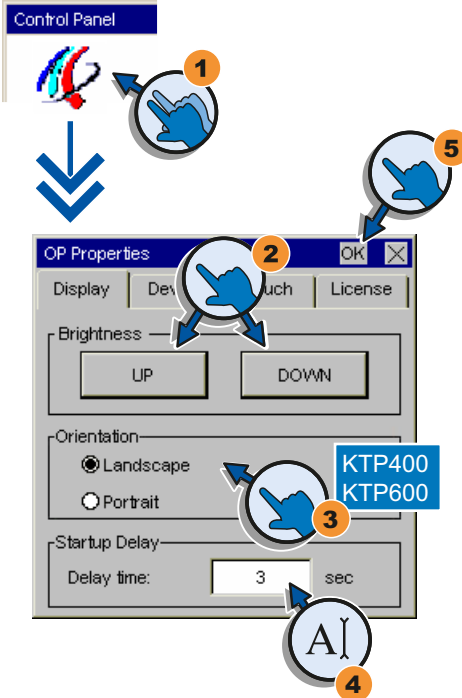

1. Press the "OP" button to open the "OP Properties" dialog.
2. Basic Panels color:
Press the "UP" and "DOWN" buttons to adjust the screen brightness.
Basic Panels mono:
Press the "UP" and "DOWN" buttons to adjust the screen contrast.
3. Only for KTP400 and KTP600:
Select the screen orientation:
 - "Landscape" for landscape
 - "Portrait" for portrait
4. Set the delay time in the "Delay time" text box. The delay time in seconds defines the waiting time expiring between the appearance of the loader and the start of the project.
Valid range of values: 0 s to 60 s.
5. Close the dialog and save your entries with "OK".

Note

Immediate start of the project with a delay time of 0 seconds

The project starts immediately if a delay time of 0 seconds is set. It is then no longer possible to call the Loader after switching on the HMI device. To handle this situation, you need to configure an operator control with the "Close project" function.

5.6 Displaying information about the HMI device

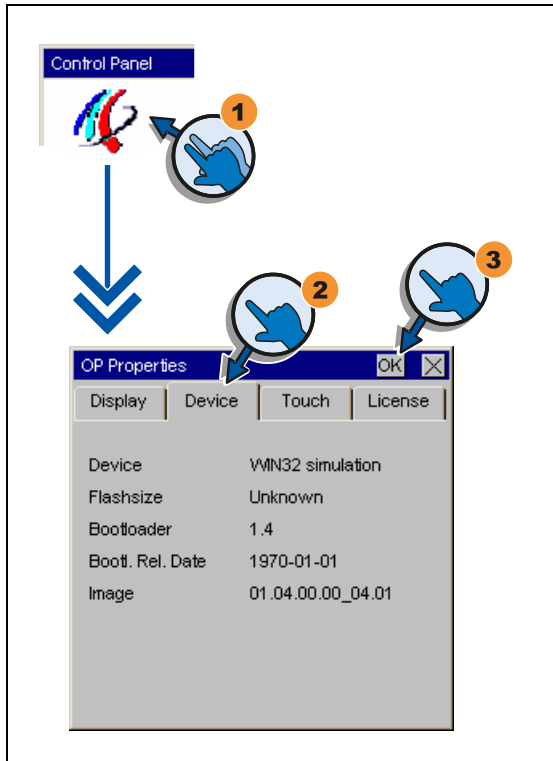

1. Press the "OP" button to open the "OP Properties" dialog.

2. Change to the "Device" tab.

The "License" tab is used to display specific information on the HMI device. You will need this information when contacting Technical Support.

- "Device:" HMI device name
- "Flashsize": Size of internal flash memory to which the HMI device image and project data are saved. The size of internal flash memory is not equivalent to application memory available for a project.
- "Bootloader": Boot loader version
- "Bootl. Rel. Date": Release date of the boot loader
- "Image": Version of the HMI device image

3. Close the dialog with "OK".

5.7 Calibrating the touch screen

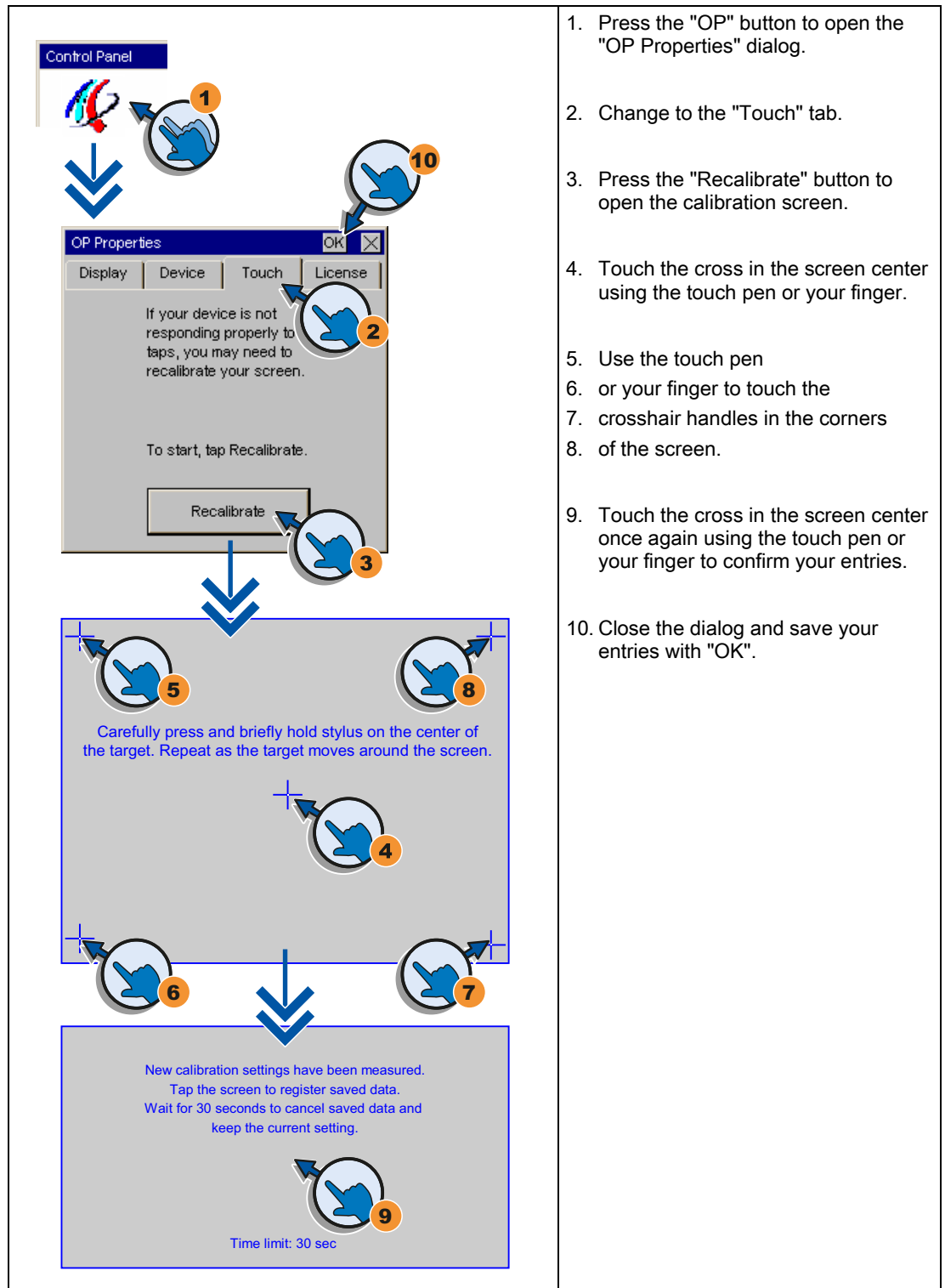

The diagram illustrates the process of calibrating the touch screen through three sequential screens:

- Control Panel:** Step 1 shows the 'Control Panel' icon being selected.
- OP Properties dialog box:** Step 2 shows the 'Touch' tab selected. Step 3 shows the 'Recalibrate' button being clicked. Step 10 shows the 'OK' button being clicked to close the dialog.
- Calibration Screen:** Step 4 shows the crosshair in the center being touched. Steps 5, 6, 7, and 8 show the crosshair being moved to the corners of the screen and touched. Step 9 shows the crosshair being touched in the center again to confirm the entries.

Additional text on the calibration screen includes: "Carefully press and briefly hold stylus on the center of the target. Repeat as the target moves around the screen." and "New calibration settings have been measured. Tap the screen to register saved data. Wait for 30 seconds to cancel saved data and keep the current setting. Time limit: 30 sec".

1. Press the "OP" button to open the "OP Properties" dialog.
2. Change to the "Touch" tab.
3. Press the "Recalibrate" button to open the calibration screen.
4. Touch the cross in the screen center using the touch pen or your finger.
5. Use the touch pen
6. or your finger to touch the
7. crosshair handles in the corners
8. of the screen.
9. Touch the cross in the screen center once again using the touch pen or your finger to confirm your entries.
10. Close the dialog and save your entries with "OK".

5.8 Displaying licensing information for the HMI device

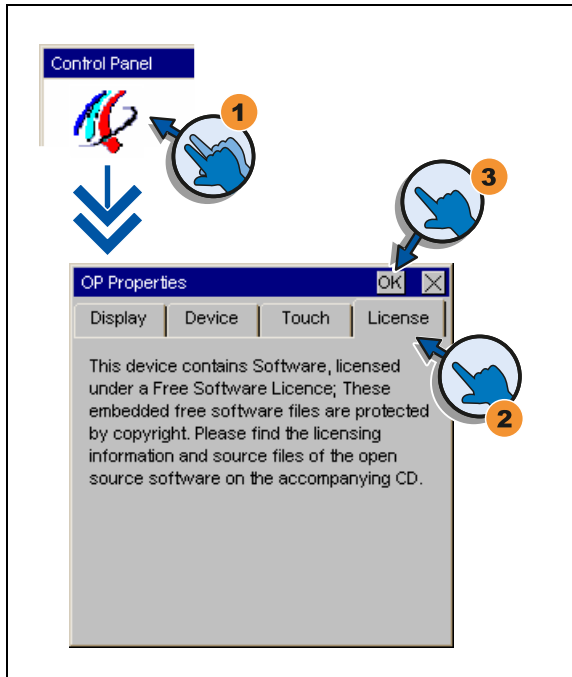

Control Panel

OP Properties

Display | Device | Touch | License

This device contains Software, licensed under a Free Software Licence; These embedded free software files are protected by copyright. Please find the licensing information and source files of the open source software on the accompanying CD.

1. Use the "OP" button to open the "OP Properties" dialog.

2. Open the "License" tab.

The "License" tab is used to display the licensing information for the software of the HMI device.

3. Close the dialog with "OK."

5.9 Enabling a data channel

You must enable at least one data channel to transfer a project to the HMI device.

Note

After having completed the project transfer, you can protect the HMI device against unintentional overwriting of project data and of the HMI device image by locking all data channels.

Enabling a data channel - Basic Panels DP

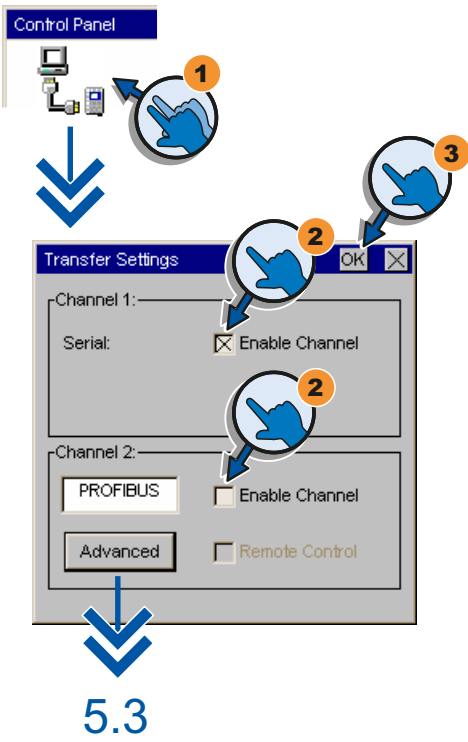
	<ol style="list-style-type: none">1. Press the "Transfer" button to open the "Transfer Settings" dialog.2. If the HMI device is interconnected with the configuration PC via PC-PPI cable, activate the "Enable Channel" check box in the "Channel 1" field. If the HMI device is interconnected with a programming device via PROFIBUS, activate the "Enable Channel" check box in the "Channel 2" field. Press the "Advanced" button to open the "MPI / Profibus Settings" dialog. Verify the PROFIBUS parameters in this dialog. A description of the "MPI / Profibus Settings" dialog is provided in chapter 5.3, Changing MPI/DP settings (Page 55).3. Close the dialog and save your entries with "OK".
--	---

Note

Automatic transfer is activated by setting the "Remote Control" check box. If automatic transfer is activated, the HMI device can be set remotely to transfer mode by a configuration PC or programming device.

Enabling a data channel - Basic Panels PN

1. Press the "Transfer" button to open the "Transfer Settings" dialog.

2. Select the "Enable Channel" check box in the "Channel 1" field.

Press the "Advanced" button to open the "Profinet Settings" dialog. Verify the network parameters in this dialog. A description of the "Profinet Settings" dialog is provided in chapter 5.4, Changing the network configuration (Page 56).

3. Close the dialog and save your entries with "OK".

5.4

Note

Automatic transfer is activated by setting the "Remote Control" check box. If automatic transfer is activated, the HMI device can be set to transfer mode by a remote configuration PC or a programming device.

5.10 Changing password settings

Password protection prevents unauthorized access to the Control Panel.

NOTICE

The password cannot contain spaces or special characters * ? . % / \ ' " .

If the password is no longer available for the Control Panel, you first have to update the operating system before you can make any changes in the Control Panel. All data on the HMI device will be overwritten when you update the operating system.

Procedure – activating password protection

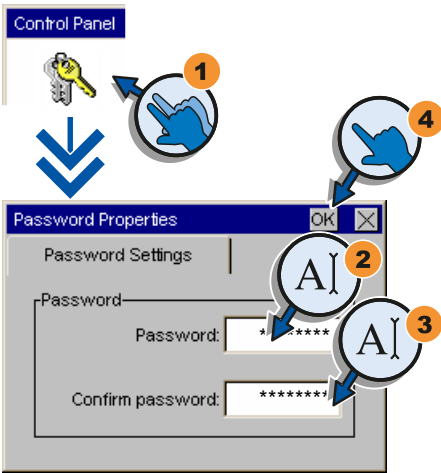
	<ol style="list-style-type: none">1. Press the "Password" button to open the "Password Properties" dialog.2. Enter a password in the "Password" text box. Touch the text box. The alphanumerical screen keyboard is displayed.3. Confirm the password in the "Confirm Password" text box.4. Close the dialog and save your entries with "OK".
--	--

Procedure – Deactivating password protection

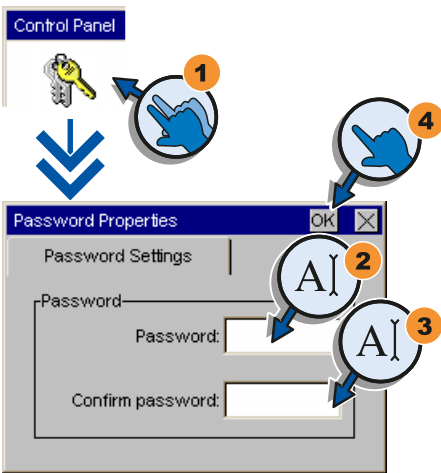
	<ol style="list-style-type: none">1. Press the "Password" button to open the "Password Properties" dialog.2. Delete the entries in the "Password" text box.3. Delete the entries in the "Confirm Password" text box.4. Close the dialog and save your entries with "OK".
---	---

5.11 Setting the Screen Saver

NOTICE

Burn-in effect

The screen contents may leave a faint version (ghost) of the image in the background if they appear for too long.

The "ghost" will disappear automatically after some time. The longer the same content is displayed on the screen, the longer it will take for the burn-in effect to disappear.

The screen saver helps to prevent burn-in.

Always use the screen saver.

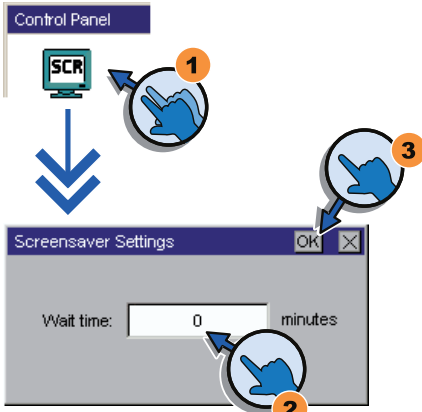
	<ol style="list-style-type: none">1. Press the "Screensaver" button to open the "Screensaver Settings" dialog.2. Enter the number of minutes before the screen saver is to be activated. Touch the text box to do this. You can enter values from 5 to 360 minutes. Entering "0" disables the screen saver.3. Close the dialog and save your entries with "OK".
--	---

5.12 Setting acoustic signals

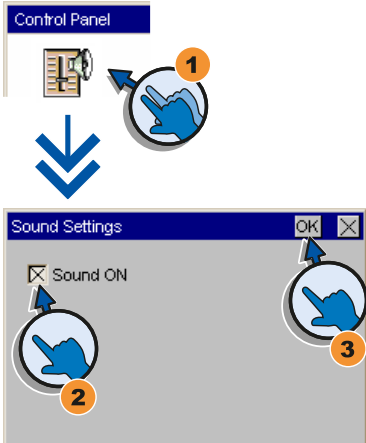
	<ol style="list-style-type: none">1. Use the "Volume Setting" button to open the "Sound Settings" dialog.2. Select the "Sound ON" check box. When the "Sound ON" check box is activated, you get acoustic feedback in the following cases:<ul style="list-style-type: none">- Touch the touch screen.- A message is displayed.3. Close the dialog and save your entries with "OK".
---	---

Commissioning a project

6.1 Overview

Configuration phase

A project – the process image of the working process – is produced during configuration to visualize automated working processes. The process displays for the project contain displays for values and messages which provide information about process statuses. The process control phase follows the configuration phase.

Process control phase

The project must be transferred to the HMI device if it is to be used in process control. Another precondition for process control is that the HMI device is connected online to a controller. Current working processes - operating and observing - can then be subject to process control.

Transferring the project to the HMI device

You can transfer a project to an HMI device as follows:

- Transfer from the configuring PC
- Restore from a PC using ProSave

In this case, an archived project is transferred from a PC to the HMI device. The configuration software need not be installed on this PC.

Commissioning and recommissioning

Initial and re-start-ups differ in the following respects:

- When the HMI device is commissioned there is no project at first.
The HMI device is also in this state after the operating system has been updated.
- When recommissioning, any project already on the HMI device is replaced.

6.2 Operating modes

Operating modes

The HMI device may be in the following operating modes:

- Offline
- Online
- Transfer

"Offline mode" and "Online mode" can be set on both the configuring PC and the HMI device. To set these modes on the HMI device, use a corresponding operating element of the project.

Changing the operating mode

The configuration engineer must have configured an appropriate operating element to allow a change of the operating mode on the HMI device during ongoing operation.

Further information on this may be available in your plant documentation

"Offline" operating mode

In this mode, there is no communication between the HMI device and PLC. Although the HMI device can be operated, it cannot exchange data with the PLC.

"Online" operating mode

In this mode, the HMI device and PLC communicate. You can operate the plant on the HMI device according to your system configuration.

"Transfer" mode

In this mode, you can transfer a project from the configuring PC to the HMI device or backup and restore HMI device data, for example.

The following options are available for setting "Transfer" mode on the HMI device:

- When the HMI device starts up

Start "Transfer" mode manually in the HMI device Loader.

- During ongoing operation

Start the "Transfer" mode manually within the project using an operating element. The HMI device toggles to "Transfer" mode when automatic mode is set and a transfer is initiated on the configuring PC.

6.3 Data transmission options

Overview

The following table shows the options for data transfer between the HMI device and configuration PC.

Type	Data channel	Basic Panels DP	Basic Panels PN
Backup/restore, Operating system update Project transfers	Serial ¹⁾	Yes	-
	MPI/PROFIBUS DP	Yes	-
	PROFINET	-	Yes
Updating the operating system with "Reset to factory settings"	Serial ¹⁾	Yes	-
	MPI/PROFIBUS DP	-	-
	PROFINET	-	Yes

¹⁾ Applies for operations with PC/PPI cable 6ES7 901-3CB30-0XA0 or USB/PPI cable 6ES7 901-3DB30-0XA0.

6.4 Transfer

6.4.1 Overview

Transfer the executable project from the configuration PC to the HMI device.

You can start the "Transfer" mode manually or automatically on the HMI device.

Transferred data is written directly to internal flash memory of the HMI device. Parameterize a corresponding data channel before you start the transfer.

6.4.2 Starting manual transfer

Introduction

You can manually switch the HMI device to "Transfer" mode as follows:

- At runtime, using a configured operator control.
- In the Loader of the HMI device.

Requirements

- The "*.hmi" project is open in WinCC flexible.
- The HMI device is connected to a configuration PC.
- The data channel is parameterized on the HMI device.
- The HMI device is in "Transfer" mode.

Procedure

Proceed as follows:

1. On the configuration PC, select the "Transfer settings" command from the "Project > Transfer" menu in WinCC flexible.

The "Select devices for transfer" dialog opens.

2. Select the HMI device in the left area of the dialog.
3. Select the type of interconnection for the HMI device and the configuration PC.
Set the connection parameters.

4. Set the transfer parameters in the right area of the dialog.

5. Start the transfer in WinCC flexible by selecting "Transfer".

The configuration PC checks the connection to the HMI device. The project is transferred to the HMI device. An error message is displayed on the configuration PC if the connection is either not available, or disrupted.

Result

The project is available on the HMI device after successful completion of the transfer. The transferred project is started automatically.

6.4.3 Starting automatic transfer

Introduction

If automatic transfer is activated, the HMI device automatically changes to "Transfer" mode at runtime as soon as a transfer is started on the connected configuration PC.

Note

With automatic transfer, the HMI device only changes into "Transfer" mode when the project is running on the HMI device.

Automatic transfer is particularly suited for the test phase of a new project since transfer is completed without interfering with the HMI device.

NOTICE

If automatic transfer is activated on the HMI device and a transfer is initiated on the configuration PC, the project currently running is automatically stopped. The HMI device then automatically switches to "Transfer" mode.
--

After the commissioning phase, deactivate the automatic transfer so that the HMI device cannot be inadvertently switched to transfer mode. Transfer mode can trigger unintentional actions in the plant.
--

You can issue a password in the Control Panel to restrict access to the transfer settings and thus avoid unauthorized modifications.
--

Requirements

- The *.hmi project is opened in WinCC flexible.
- The HMI device is connected to a configuration PC.
- The data channel is configured on the HMI device
- The automatic transfer is activated in the data channel for the transfer
- The project is started on the HMI device.

Procedure

Proceed as follows:

1. On the configuration PC, select the "Transfer settings" command from the "Project > Transfer" menu in WinCC flexible.

The "Select devices for transfer" dialog opens.

2. Select the HMI device in the left area of the dialog.
3. Select the type of interconnection for the HMI device and the configuration PC.
Set the connection parameters.

4. Set the transfer parameters in the right area of the dialog.

5. Start the transfer in WinCC flexible by selecting "Transfer".

The configuration PC checks the connection to the HMI device. The HMI device shuts down the current project and automatically changes to "Transfer" mode. The project is transferred to the HMI device. An error message is displayed on the configuration PC if the connection is not available or disrupted.

Result

The project is available on the HMI device following successful transfer. The transferred project is started automatically.

6.4.4 Testing a project

Introduction

You have the following options to test a project:

- Test the project on the configuration PC
You can test a project at a configuration PC, using a simulator. For detailed information, refer to the "WinCC flexible" user manual and to the WinCC flexible online help.
- Offline testing of the project on the HMI device
Offline testing means that communication between the HMI device and PLC is down while the test is being carried out.
- Online testing of the project on the HMI device
Online testing means that the HMI device and PLC communicate with each other during testing.

Perform the tests, starting with the "Offline test", followed by the "Online test".

Note

You should always test the project on the HMI device on which the project will be used.

Check the following:

1. Check the correct layout of the screens.
2. Check the screen navigation.
3. Check the input objects.
4. Enter the tag values.

The test increases the certainty that the project will run error-free on the HMI device.

Requirements for offline testing

- The project has been transferred to the HMI device.
- The HMI device is in "Offline" mode.

Procedure

In "Offline" mode, you can test individual project functions on the HMI device without them being affected by the PLC. PLC tags, therefore, are not updated.

Test the operator controls and visualization of the project as far as possible without connecting to the PLC.

Requirements for online testing

- The project has been transferred to the HMI device.
- The HMI device is in "Online" mode.

Procedure

In "Online" mode, you can test individual project functions on the HMI device without them being affected by the PLC. PLC tags are updated in this case.

You have the option to test all communication-dependent functions, for example alarms, etc.

Test the operator controls and views of the project.

6.5 Backup and restore

6.5.1 Overview

Backup and restore

You can back up and restore the following data in the internal flash memory of the HMI device with a PC:

- Project and HMI device image
- Password list
- Recipe data

Use one of the following tools for backup and restore:

- WinCC flexible
- ProSave

General information

NOTICE

Power failure

If a complete restore operation is interrupted due to power failure on the HMI device, the operating system of the HMI device may be deleted. In this case, you have to reset the HMI device to its factory settings.

Compatibility conflict

If a message is output on the HMI device warning of a compatibility conflict during the restore operation, the operating system must be updated.

Note

A data transfer can take several minutes, depending on data volume and transmission rate. Observe the status display. Do not interrupt the data transfer.

See also

Data transmission options (Page 67)

6.5.2 Backup and restore using WinCC flexible

Requirement

- No project is open on the configuration PC in WinCC flexible.
- The HMI device is connected to this configuration PC.
- The data channel is programmed on the HMI device.

Procedure – backup

Proceed as follows:

1. On the configuration PC, select the "Communication settings" command in the menu "Project > Transfer" in WinCC flexible.

The "Communication settings" dialog box opens.

2. Select the type of HMI device.
3. Select the type of connection between the HMI device and the configuration PC.

Set the connection parameters.

4. Close the dialog with "OK".
5. Select the "Backup" command in the menu "Project > Transfer" in WinCC flexible.
6. The "Backup settings" dialog opens.
7. Select the data to be backed up.
8. Select a destination folder and a file name for the "*.psb" backup file.
9. Set "Transfer" mode on the HMI device.

If automatic transfer mode is enabled on the HMI device, the HMI device automatically sets "Transfer" mode when a backup is initiated.

10. Start the backup operation in WinCC flexible with "OK" on the configuration PC.
11. Follow the instructions in WinCC flexible.

A status view opens to indicate the progress of the operation.

Result

The system outputs a message when the backup is completed.

The relevant data is now backed up on the configuration PC.

Procedure – restoring

Proceed as follows:

1. On the configuration PC, select the "Communication settings" command in the menu "Project > Transfer" in WinCC flexible.
The "Communication settings" dialog box opens.
2. Select the type of HMI device.
3. Select the type of connection between the HMI device and the configuration PC.
4. Set the connection parameters.
5. Close the dialog with "OK".
6. Select the "Restore" command in the menu "Project > Transfer" in WinCC flexible.
The "Restore Settings" dialog opens.
7. Select the "*.psb" backup file to be restored from the "Open" field.
You can see the HMI device for which the backup file was created and the type of backup data the file contains.
8. Set "Transfer" mode on the HMI device.
If automatic transfer mode is enabled on the HMI device, the device automatically sets "Transfer" mode when a restore operation is initiated.
9. Start the restore operation in WinCC flexible with "OK" on the configuration PC.
Follow the instructions in WinCC flexible.
A status view opens to indicate the progress of the operation.

Result

When the restore is successfully completed, the data backed up on the configuration PC is now on the HMI device.

6.5.3 Backup and restore using ProSave

Requirements

- The HMI device is connected to a PC on which ProSave is installed.
- The data channel is parameterized on the HMI device.

Procedure – backup

Proceed as follows:

1. Go to the Windows Start menu and start ProSave on the PC.
2. Select the HMI device type in the "General" tab.
3. Select the type of interconnection for the HMI device and the PC.
Set the connection parameters.
4. Select the data to be backed up in the "Backup" tab.
 - "Complete backup" generates a backup copy of configuration data, recipe data and the HMI device image to a file in PSB format.
 - "Recipes" generates a backup copy of the HMI device's recipe data records in PSB format.
 - "Recipes (CSV format)" saves a backup copy of the HMI device's recipe data records to a text file in CSV format. The semicolon is used as column separator.
 - "User management" generates a backup copy of the HMI device's user data in PSB format.
5. Select the folder and file name for the *.psb" backup file .
When generating a backup copy of recipes in CSV format, only select a folder. A CSV file is generated for each recipe in this folder.
6. Set "Transfer" mode on the HMI device.
If automatic transfer mode is enabled on the HMI device, the HMI device automatically sets "Transfer" mode when a backup is initiated.
7. Start the backup operation in ProSave with "Start Backup".
Follow the instructions in ProSave.
A progress bar opens to indicate the progress of the operation.

Result

The system outputs a message when the backup is completed.
A backup copy of the data is now available on the PC.

Procedure – restore

Proceed as follows:

1. Go to the Windows Start menu and start ProSave on the PC.
2. Select the HMI device type in the "General" tab.
3. Select the type of interconnection for the HMI device and the PC.
4. Set the connection parameters.
5. Select the "*.psb" backup file to be restored from the "Restore" tab.

You can see the HMI device for which the backup file was created and the type of backup data the file contains.

Select one or several CSV files from the source folder to restore the recipes from CSV files.

6. Set "Transfer" mode on the HMI device.

If automatic transfer mode is enabled on the HMI device, the device automatically sets "Transfer" mode when a restore operation is initiated.

7. Start the restore operation in ProSave on the PC with "Start Restore".
8. Follow the instructions in ProSave.

A progress bar indicates the progress of the operation.

Result

When the restore is successfully completed, the data backed up on the PC is now on the HMI device.

6.6 OS update - Basic Panel DP

6.6.1 Overview

Updating the operating system

A compatibility conflict may occur when transferring a project to the HMI device. This is caused by different versions of the configuration software used and the HMI device image available on the HMI device. If there are different versions, the transfer is aborted. A message indicating a compatibility conflict is displayed on the configuration PC.

There are two ways to match the versions:

- Update the HMI device image if the project was created with the most recent version of the configuration software.
- Transfer a matching version of the HMI device image if you do not want to adapt the project for the HMI device to the most recent version of the configuration software for the project.

NOTICE
Data loss
All data on the HMI device, such as the project and licenses, will be deleted when you update the operating system.

Note

Calibrating the touch screen

After the update, you may have to recalibrate the touch screen.

6.6.2 Resetting factory settings

In ProSave or WinCC flexible, you can perform an operating system update with or without reset to factory settings.

- Updating the operating system without reset to factory settings

First, switch into "Transfer" mode on the HMI device or use the automatic transfer function if the project is active. Then start the operating system update in ProSave or WinCC flexible.

- Updating the operating system with reset to factory setting

NOTICE
Data channels
When resetting to factory settings, all data channel parameters are reset. The transfer can only be started following reconfiguration of the data channels.

Note

You have to perform an operating system update with reset to factory setting if the HMI device does not yet have an operating system or if the HMI device's operating system is corrupt.

First, start the operating system update in ProSave or WinCC flexible and switch the power on the HMI device off and on again when prompted.

See also

Data transmission options (Page 67)

6.6.3 Updating the Operating System using WinCC flexible

Requirement

- The HMI device is connected to a configuration PC.
- No project is open in WinCC flexible.
- When updating the operating system without reset to factory setting only:
The data channel is configured on the HMI device.

Procedure

Proceed as follows:

1. When updating the operating system with reset to factory setting only:
Switch off power to the HMI device.
2. On the configuration PC, select the "Communication settings" command in the menu "Project > Transfer" in WinCC flexible.
The "Communication Settings" dialog opens.
3. Select the type of HMI device.
4. Select the type of connection between the HMI device and the configuration PC, then set the connection parameters.
5. Close the dialog box with "OK".
6. Select the "OS Update" command from the "Project > Transfer" menu in WinCC flexible.
7. Select whether to update the operating system with or without restoring the factory settings by setting the "Reset to factory settings" check box accordingly.
8. Select the HMI device image file "*.img" under "Image path".
The HMI device image files are available under "WinCC flexible Images" in the WinCC flexible installation folder or on the WinCC flexible installation DVD.
The output area provides information on the version of the successfully opened HMI device image file.
9. When updating without reset to the factory settings only:
Set "Transfer" mode on the HMI device.
If automatic transfer mode is enabled on the HMI device, the device automatically sets "Transfer" mode when an update is initiated.
10. In WinCC flexible, select "Update OS" on the configuration PC to run the operating system update.
11. When updating with reset to the factory settings only:
Switch on the power supply to the HMI device.
12. Follow the instructions in WinCC flexible.
A progress bar indicates the progress of the operating system update.

Result

A message is displayed when the operating system update is successfully completed.
The HMI device no longer contains any project data.

6.6.4 Updating the Operating System using ProSave

Requirement

- The HMI device is connected to a PC on which ProSave is installed.
- When updating the operating system without reset to factory settings only:
The data channel is configured on the HMI device.

Procedure

Proceed as follows:

1. When updating the operating system with reset to factory settings only:
Switch off power to the HMI device.
2. Go to the Windows Start menu and start ProSave on the PC.
3. Select the HMI device type in the "General" tab.
4. Select the type of connection between the HMI device and the PC, then set the connection parameters.
5. Select the "OS Update" tab.
6. Select whether to update the operating system with or without restoring the factory settings by setting the "Reset to factory settings" check box accordingly.
7. Select the HMI device image file "*.img" under "Image path".
The HMI device image files are available under "WinCC flexible Images" in the WinCC flexible installation folder or on the WinCC flexible installation DVD.
The output area provides information on the version of the successfully opened HMI device image file.
8. When updating without reset to the factory settings only:
Set "Transfer" mode on the HMI device.
If automatic transfer mode is enabled on the HMI device, the device automatically sets "Transfer" mode when an update is initiated.
9. Select "Update OS" on the PC to run the operating system update.
10. When updating with reset to the factory settings only:
Switch on the power supply to the HMI device.
11. Follow the instructions in ProSave.
A progress bar indicates the progress of the operating system update.

Result

A message is displayed when the operating system update is successfully completed.
The HMI device no longer contains any project data.

6.7 OS update - Basic Panel PN

6.7.1 Overview

Updating the operating system

A compatibility conflict may occur when transferring a project to the HMI device. This is caused by different versions of the configuration software used and the HMI device image available on the HMI device. If there are different versions, the transfer is aborted. A message indicating a compatibility conflict is displayed on the configuration PC.

There are two ways to match the versions:

- Update the HMI device image if the project was created with the most recent version of the configuration software.
- Transfer a matching version of the HMI device image if you do not want to adapt the project for the HMI device to the most recent version of the configuration software for the project.

NOTICE
Data loss
All data on the HMI device, such as the project and licenses, will be deleted when you update the operating system.

Note

Calibrating the touch screen

After the update, you may have to recalibrate the touch screen.

6.7.2 Resetting factory settings

In ProSave or WinCC flexible, you can perform an operating system update with or without reset to factory settings.

- Updating the operating system without reset to factory settings

First, switch into "Transfer" mode on the HMI device or use the automatic transfer function if the project is active. Then start the operating system update in ProSave or WinCC flexible.

- Updating the operating system with reset to factory setting

NOTICE
Data channels
When resetting to factory settings, all data channel parameters are reset. The transfer can only be started following reconfiguration of the data channels.

Note

You have to perform an operating system update with reset to factory setting if the HMI device does not yet have an operating system or if the HMI device's operating system is corrupt.

First, start the operating system update in ProSave or WinCC flexible and switch the power on the HMI device off and on again when prompted.

See also

Data transmission options (Page 67)

6.7.3 Updating the operating system using WinCC flexible

Requirement

- No project is open on the configuring PC in WinCC flexible.
- The HMI device is connected to this configuration PC.
- The data channel is configured on the HMI device.

Procedure

Proceed as follows:

1. On the configuration PC, select the "Communication settings" command from the "Projekt > Transfer" menu in WinCC flexible.
The "Communication Settings" dialog opens.
2. Select the type of HMI device.
3. Select the type of interconnection for the HMI device and the configuration PC.
4. Set the connection parameters.
5. Close the dialog box with "OK".
6. In WinCC flexible, select the command "OS Update" from the "Projekt > Transfer" menu.
7. Select the HMI device image file "*.img" under "Image path".

The HMI device image files are available under "WinCC flexible Images" in the WinCC flexible installation folder or on the WinCC flexible installation CD.

The output area provides information on the version of the successfully opened HMI device image file.

8. Switch into "Transfer" mode on the HMI device.
If you have activated automatic transfer mode for the HMI device, the device automatically switches to "Transfer" mode when an update is initiated.
9. In WinCC flexible, select "Update OS" on the configuration PC to run the operating system update.
10. Follow the instructions in WinCC flexible.

A progress bar indicates the progress of the operating system update.

Result

A message is displayed when the operating system update is successfully completed.

The HMI device no longer contains any project data.

6.7.4 Updating the operating system using ProSave

Requirement

- The HMI device is connected to a PC on which ProSave is installed.
- The data channel is configured on the HMI device.

Procedure

Proceed as follows:

1. Go to the Windows Start menu and start ProSave on the PC.
2. Select the HMI device type in the "General" tab.
3. Select the type of connection between the HMI device and the PC.
4. Set the connection parameters.
5. Select the "OS Update" tab.
6. Select the HMI device image file "*.img" under "Image path".

The HMI device image files are available under "WinCC flexible Images" in the WinCC flexible installation folder or on the WinCC flexible installation CD.

The output area provides information on the version of the successfully opened HMI device image file.

7. Switch into "Transfer" mode on the HMI device.

If you have activated automatic transfer mode for the HMI device, the device automatically switches to "Transfer" mode when an update is initiated.

8. Select "Update OS" in the PC to run the operating system update.
9. Follow the instructions in ProSave.

A progress bar indicates the progress of the operating system update.

Result

A message is displayed when the operating system update is successfully completed.

The HMI device no longer contains any project data.

6.7.5 Resetting to factory settings with WinCC flexible

Requirement

- No project is open on the configuring PC in WinCC flexible.
- The HMI device is connected to this configuration PC over the standard Ethernet cable.
- Have the MAC address of your HMI device's Ethernet interface to hand.
 - The MAC address is displayed briefly when the HMI device is turned on.
 - The MAC address is displayed in the "Profinet" dialog of the "Device" tab in the Control Panel.

Procedure for setting the PC interface

1. Select "Start > Control Panel > Set PG / PC interface" on the configuration PC.
2. Select "S7ONLINE (STEP7) -> TCP / IP" from the "Application access point" area.
3. Select the interface which is connected to the HMI device from the "Interface parameterization used" area.
4. Confirm your entries.

Procedure for resetting factory settings

Proceed as follows:

1. On the configuration PC, select the "Communication settings" command in the menu "Project > Transfer" in WinCC flexible.
The "Communication Settings" dialog opens.
2. Select the HMI device type from the "General" tab, and select "Ethernet" from the "Connection" area.
3. Enter an IP address.

Note

Possible address conflicts with incorrect IP address

Do not use a dynamic IP configuration for "Reset factory settings".

Specify a unique IP address in which the configuration PC is located. For the duration of the update process, the HMI device is automatically assigned to the specified address.

If the HMI device has already been used with WinCC flexible or ProSave you can use the existing IP address for "Reset factory settings".

4. Confirm your entries.

5. Select the "OS Update" command from the "Project > Transfer" menu in WinCC flexible.
6. Select the "Reset factory settings" check box.
A text box opens where you can enter the MAC address.
7. Enter the HMI device's MAC address in the text box.
8. Select the HMI device image file "*.img" under "Image path".
The HMI device image files are available under "WinCC flexible Images" in the WinCC flexible installation folder or on the WinCC flexible installation DVD.
The output area provides information on the version of the successfully opened HMI device image file.
9. In WinCC flexible, select "Update OS" on the configuration PC to run the operating system update.
10. Follow the instructions in WinCC flexible on the configuration PC.
A progress bar indicates the progress of the operating system update.

Result

A message is displayed when the operating system update is successfully completed.
The HMI device no longer contains any project data. The factory settings are reset.

Note

If you can no longer call the Control Panel on the HMI device, as the operating system is missing, switch off the HMI device. Then reset to factory settings and restart the HMI device.
If the HMI device doesn't start up, switch it off and then on again.

Note

Calibrating the touch screen

After the restore, you may have to re-calibrate the touch screen.

6.7.6 Resetting to factory settings with ProSave

Requirement

- The HMI device is connected over the Ethernet to a PC on which ProSave is installed.
- Have the MAC address of your HMI device's Ethernet interface to hand.
 - The MAC address is displayed briefly when the HMI device is turned on.
 - The MAC address is displayed in the "Profinet" dialog of the "Device" tab in the Control Panel.

Procedure for setting the PC interface

1. Select "Start > Control Panel > Set PG / PC interface" on the configuration PC.
2. Select "S7ONLINE (STEP7) -> TCP / IP" from the "Application access point" area.
3. Select the interface which is connected to the HMI device from the "Interface parameterization used" area.
4. Confirm your entries.

Procedure for resetting factory settings

Proceed as follows:

1. Go to the Windows Start menu and start ProSave on the PC.

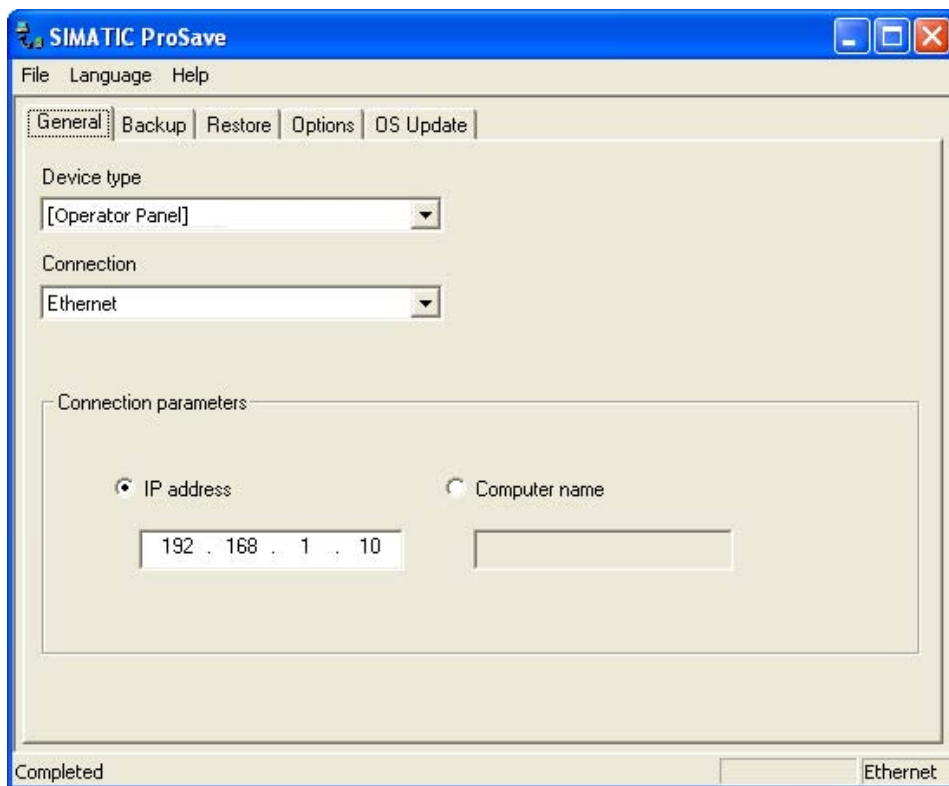

2. Select the HMI device type from the "General" tab, and select "Ethernet" from the Connection area.

3. Enter an IP address.

Note

Possible address conflicts with incorrect IP address

Do not use a dynamic IP configuration for "Reset factory settings".

Specify a unique IP address of the subnet in which the configuration PC is located. For the duration of the update process, the HMI device is automatically assigned to the specified address of ProSave.

If the HMI device has already been used with WinCC flexible or ProSave you can use the existing IP address for "Reset factory settings".

4. Change to the "OS Update" tab.
5. Select the "Reset factory settings" check box.
A text box opens where you can enter the MAC address.
6. Enter the HMI device's MAC address in the text box.
7. Select the HMI device image file "*.img" under "Image path".
The HMI device image files are available under "WinCC flexible Images" in the WinCC flexible installation folder or on the WinCC flexible installation DVD.
The output area provides information on the version of the successfully opened HMI device image file.
8. Select "Update OS" on the PC to start the "Reset to factory settings" process.
9. Follow the instructions in ProSave.
A progress bar indicates the progress of the operating system update.

Result

A message is displayed when the operating system update is successfully completed.
The HMI device no longer contains any project data. The factory settings are reset.

Note

If you can no longer call the Control Panel on the HMI device, as the operating system is missing, switch off the HMI device. Then reset to factory settings and restart the HMI device.

If the HMI device doesn't start up, switch it off and then on again.

Note

Calibrating the touch screen

After the restore, you may have to re-calibrate the touch screen.

Maintenance and care

7.1 Maintenance and care

Introduction

The HMI device is designed for maintenance-free operation. The touch screen and keyboard membrane should nevertheless be cleaned regularly.

Requirements

Use a cleaning cloth dampened with a cleaning agent to clean the equipment. Only use water with a little liquid soap or a screen cleaning foam.

NOTICE

Unintentional response

When cleaning the touch screen, an unintentional response in the controller can be triggered by touching keys.

Switch the HMI device off before cleaning to prevent unintentional responses.

Damage caused by unauthorized cleaning products

The HMI device may be damaged if compressed air, steam jet-air ejectors, aggressive solvents or scouring powders are used for cleaning purposes.

Do not clean the HMI device with compressed air or steam jet blowers. Do not use aggressive solvents or scouring powder.

Procedure

Proceed as follows:

1. Switch off the HMI device.
2. Spray the cleaning solution onto a cleaning cloth.
Do not spray directly onto the HMI device.
3. Clean the HMI device.
When cleaning the display wipe from the screen edge inwards.

7.2 Recycling

Recycling and disposal

The HMI devices described in these operating instructions can be recycled due to the low levels of pollutants. Contact a certified disposal service company for environmentally sound recycling and disposal of your old devices.

Technical specifications

8.1 Standards, certificates and approvals

Approvals

 CAUTION
<p>The following overview shows possible approvals.</p> <p>The HMI device itself is certified as shown on the rear panel labels.</p>

CE approval



The HMI device meets the general and safety-related requirements of the following EC directives and conforms to the harmonized European standards (EN) for programmable logic controllers published in the official gazettes of the European Union:

- 2006/95/EG "Low Voltage Directive"
- 2004/108/EC "Electromagnetic Compatibility" (EMC Directive)
- Specific absorption rate to EN 50392

EC Declaration of Conformity

The EC Declarations of Conformity are available to the relevant authorities at the following address:

Siemens AG
 Industry Sector
 I IA AS RD ST PLC
 PO Box 1963
 D-92209 Amberg

Marking for Australia



The HMI device fulfills the requirements of standard AS/NZS 2064 (Class A).

UL approval



Underwriters Laboratories Inc., to

- UL 508 (Industrial Control Equipment)
- CSA C22.2 No. 142 (Process Control Equipment)

IEC 61131

The HMI device fulfills requirements and criteria to IEC 61131-2, Programmable Logic Controllers, Part 2: Operating resource requirements and tests.

8.2 Electromagnetic compatibility

Introduction

The HMI device fulfills, among other things, the requirements of the EMC law pertaining to the domestic European market.

EMC-compatible installation of the HMI device

The EMC-compliant installation of the HMI device and the application of interference-proof cable is the basis for interference-free operation. The "Directives for interference-free installation of PLCs" and the "PROFIBUS Networks" manual also apply for the installation of the HMI device.

Pulse-shaped disturbance

The following table shows the electromagnetic compatibility of modules with regard to pulse-shaped interference. The precondition for electromagnetic compatibility is that the HMI device meets the specifications and guidelines for electrical installation.

Pulse-shaped disturbance	Tested with	Degree of severity
Electrostatic discharge in accordance with IEC 61000-4-2	Air discharge: 8 kV Contact discharge: 6 kV	3
Burst pulses (high-speed transient interference) in accordance with IEC 61000-4-4	2 kV power supply cable 2 kV signal cable, > 30 m 1 kV signal cable, < 30 m	3
High-power surge pulses in accordance with IEC 61000-4-5, external protective circuit required (refer to the manual Automation System S7-300, Installation, "Lightning and overvoltage protection" section)		
Asymmetrical coupling	2 kV power cable DC voltage with protective elements 2 kV signal/data cable, > 30 m, with protective elements as required	3
Symmetrical coupling	1 kV power cable DC voltage with protective elements 1 kV signal cable, > 30 m, with protective elements as required	3

Sinusoidal interference

The following table shows the EMC behavior of the modules with respect to sinusoidal interference. This requires the HMI device to meet the specifications and directives for electrical installation.

Sinusoidal interference	Test values	Degree of severity
HF radiation (in electromagnetic fields) in accordance with IEC 61000-4-3	<ul style="list-style-type: none"> • 80% amplitude modulation at 1 kHz with 10 V/m in the range of 80 MHz to 1 GHz with 3 V/m in the range 1.4 GHz to 2 GHz with 1 V/m the range 2 GHz to 2.7 GHz • 10 V/m with 50% pulse modulation at 900 MHz 10 V/m with 50% pulse modulation at 1.89 GHz 	3
RF interference current on cables and cable shielding conforming to IEC 61000-4-6	Test voltage 10 V, with 80% amplitude modulation of 1 kHz in the 9 MHz to 80 MHz range	3

Emission of radio interference

The following table shows the unwanted emissions from electromagnetic fields in accordance with EN 55011, Limit Value Class A, Group 1, measured at a distance of 10 m.

From 30 to 230 MHz	< 40 dB (µV/m) quasi-peak
From 230 to 1000 MHz	< 47 dB (µV/m) quasi-peak

Additional measures

To connect an HMI device to the public electric network, you must ensure its compliance with Limit Value Class B to EN 55022.

8.3 Transport and storage conditions

Mechanical and climatic conditions for transportation and storage

The transport and storage conditions of this HMI device exceed requirements in accordance with IEC 61131-2. The following specifications apply to the transport and storage of an HMI device in its original packaging.

The climatic conditions conform to the following standards:

- IEC 60721-3-3, Class 3K7 for storage
- IEC 60721-3-2, Class 2K4 for transport

Mechanical requirements conform to EC 60721-3-2, Class 2M2.

Type of condition	Permitted range
Drop test (in transport package)	≤ 1 m
Temperature	From -20 to +60 °C
Atmospheric pressure	From 1080 hPa to 660 hPa, corresponds to an elevation of -1000 to 3500 m
Relative humidity	From 10 % to 90 %, without condensation
Sinusoidal vibration in accordance with IEC 60068-2-6	5 to 8.4 Hz: 3.5 mm 8.4 to 500 Hz: 9.8 m/s ²
Shock conforming to IEC 60068-2-29	250 m/s ² , 6 ms, 1000 shocks

NOTICE

Ensure that no condensation (dewing) develops on or inside the HMI device after transporting it at low temperatures or after it has been exposed to extreme temperature fluctuations.

The HMI device must have acquired room temperature before it is put into operation. Do not expose the HMI device to direct radiation from a heater in order to warm it up. If dewing has developed, wait approximately 4 hours until the HMI device has dried completely before switching it on.

Proper transport and storage, installation and assembly as well as careful operation and maintenance are required to ensure trouble-free and safe operation of the HMI device.

The warranty for the HMI device will be deemed void if these stipulations are not heeded.

8.4 Conditions of use

Mechanical and climatic conditions of use

The HMI device is designed for use in a location protected from the effects of the weather. The conditions of use are compliant with requirements to DIN IEC 60721-3-3:

- Class 3M3 (mechanical requirements)
- Class 3K3 (climatic requirements)

Use with additional measures

The HMI device should not be used at the following locations unless additional measures are taken:

- In locations with a high degree of ionizing radiation
- In locations with difficult operating conditions - for example due to:
 - Corrosive vapors, gases, oils or chemicals
 - Electrical or magnetic fields of high intensity
- In plants that require special monitoring - for example:
 - Elevators
 - Systems in especially hazardous rooms

Mechanical ambient conditions

The mechanical ambient conditions for the HMI device are specified in the following table in terms of sinusoidal vibration.

Frequency range in Hz	Constant	Occasional
$10 \leq f \leq 58$	Amplitude 0.0375 mm	Amplitude 0.075 mm
$58 \leq f \leq 150$	Constant acceleration 0.5 g	Constant acceleration 1 g

Reducing vibrations

If the HMI device is subjected to greater shocks or vibrations, you must take appropriate measures to reduce acceleration or amplitudes.

We recommend fitting the HMI device to vibration-absorbent material (on metal shock absorbers, for example).

Testing mechanical ambient conditions

The following table provides information on the type and scope of tests for mechanical ambient conditions.

Tested for	Test standard	Comments
Vibrations	Vibration test in accordance with IEC 60068, part 2-6 (sinusoidal)	Type of vibration: Transitional rate of the frequency: 1 octave/minute. 10 Hz ≤ f ≤ 58 Hz, constant amplitude of 0.075 mm 58 Hz ≤ f ≤ 150 Hz, constant acceleration 1 g Vibration duration: 10 frequency cycles per axis at each of the three associated vertical axes
Shock	Shock test in accordance with IEC 60068, Part 2 -27	Type of shock: Half-sine Shock intensity: Peak value 15 g, duration 11 ms Direction of impact: 3 shocks in ± direction at each one of the three associated vertical axes

Climatic ambient conditions

The following table shows the climatic ambient conditions for operation of the HMI device.

Ambient conditions	Permitted range	Comments
Temperature <ul style="list-style-type: none"> • Vertical mounting • Mounting at an angle 	From 0 to 50° C From 0 to 40° C	Slope angle max. 35°
Relative humidity	10 to 90 %, without condensation	
Atmospheric pressure	1080 to 795 hPa	Corresponds to an elevation of – 1,000 to 2,000 m
Pollutant concentration	SO ₂ : < 0.5 ppm; Relative humidity < 60%, no condensation	Test: 10 cm ³ /m ³ ; 10 days
	H ₂ S: < 0.1 ppm; Relative humidity < 60%, no condensation	Test: 1 cm ³ /m ³ ; 10 days

8.5 Information on insulation tests, protection class and degree of protection

Test voltages

Insulation strength is demonstrated in the type test with the following test voltages in accordance with IEC 61131-2:

Circuits with a nominal voltage of U_n to other circuits or ground	Test voltage
< 50 V	500 VDC

Protection class

Protection Class I in accordance with IEC 60536, i.e. PE/ground terminal to profile rail required!

Protection against foreign objects and water

Degree of protection in accordance with IEC 60529	Explanation
Front	When mounted: <ul style="list-style-type: none"> • IP65 • Enclosure Type 4X/Type 12 (indoor use only)
Rear panel	IP20 Touch protection test with standard test probes. There is no protection against ingress by water.

The degree of protection at the front can only be guaranteed if the mounting seal is installed flush to the mounting cut-out. Read the corresponding information in section "Making the mounting cut-out".

See also

Making the mounting cut-out (Page 25)

8.6 Power supply

CAUTION
Safe electrical isolation Use only 24 VDC power supply units with safe electrical isolation in accordance with IEC 60364-4-41 or HD 384.04.41 (VDE 0100, Part 410), e.g. to PELV standard. The supply voltage must be within the specified voltage range. Otherwise, malfunction at the HMI device cannot be ruled out. Applies to non-isolated plant configurations: Connect the connection for GND 24 V from the 24 V power supply output to equipotential bonding for uniform reference potential. You should always select a central point of termination.

The following table shows the permitted rated voltage and the corresponding tolerance range.

Rated voltage	Tolerance range
+24 VDC	19.2 to 28.8 V (-20%, +20%)

8.7 Dimension drawings

8.7.1 Dimensional drawing of KTP400 Basic

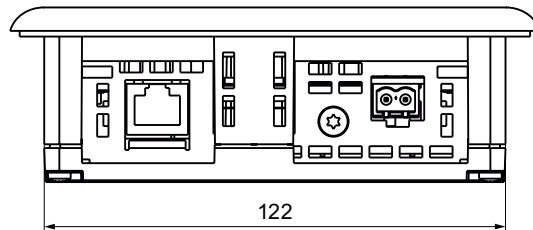

All dimensions in mm.

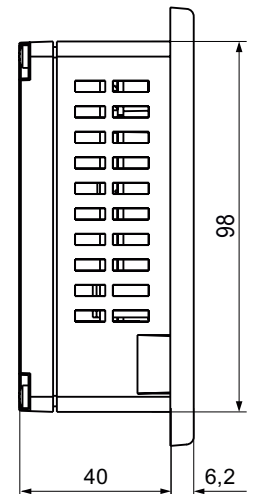
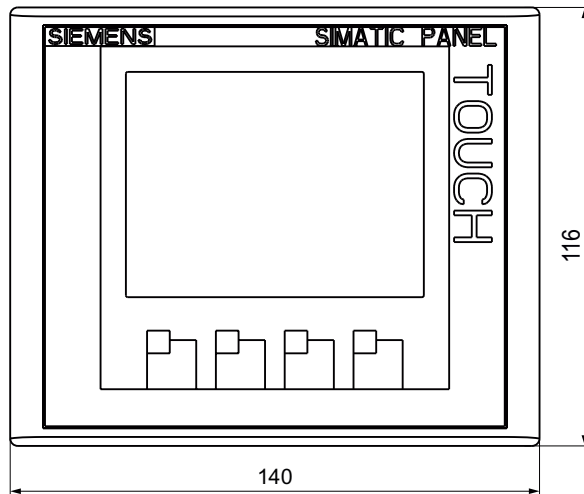

8.7.2 Dimensional drawing of KTP600 DP Basic

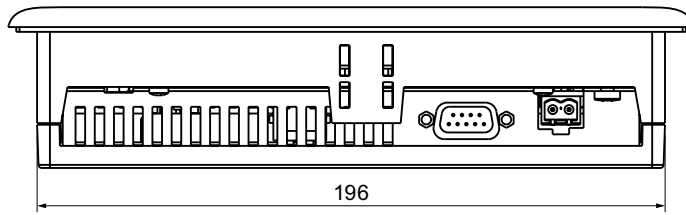

All dimensions in mm.

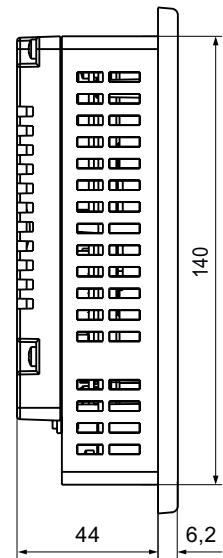
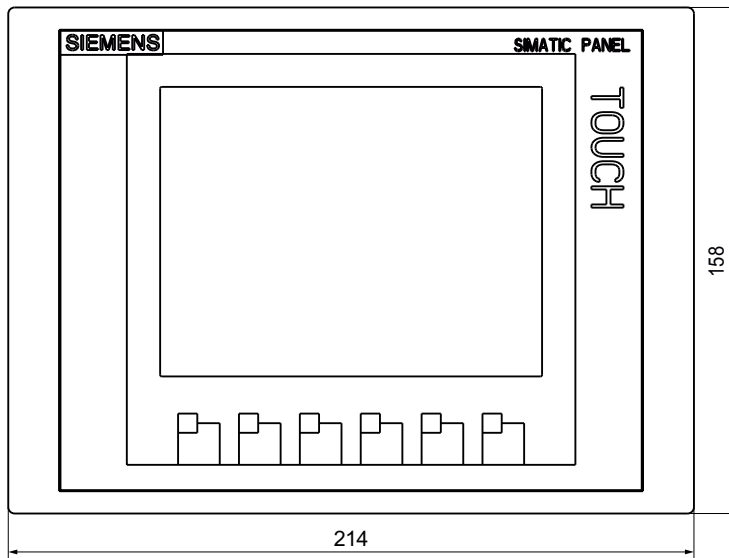

8.7.3 Dimensional drawing of KTP600 PN Basic

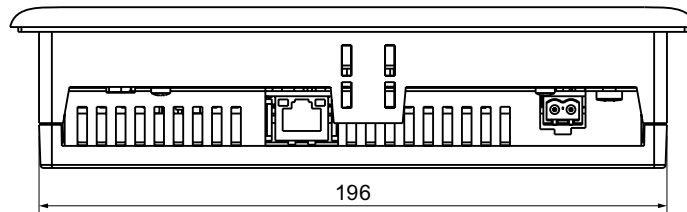

All dimensions in mm.

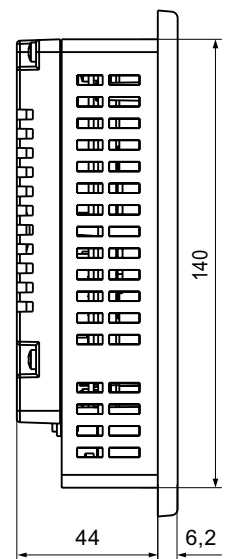
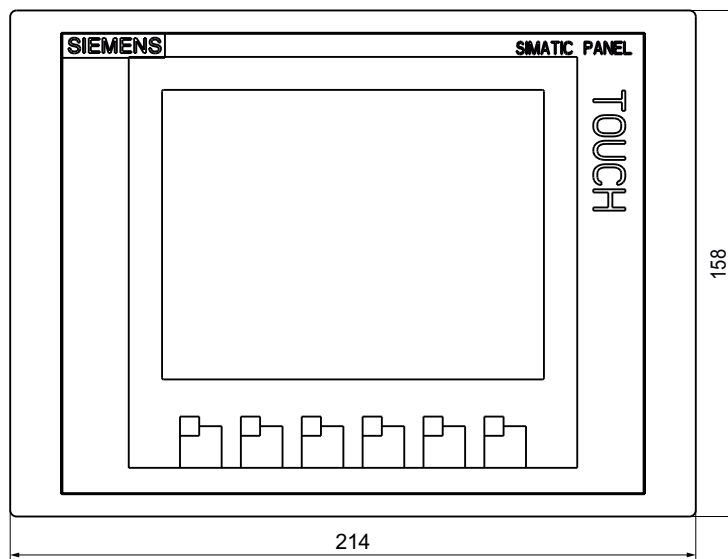

8.7.4 Dimensional drawing of KTP1000 DP Basic

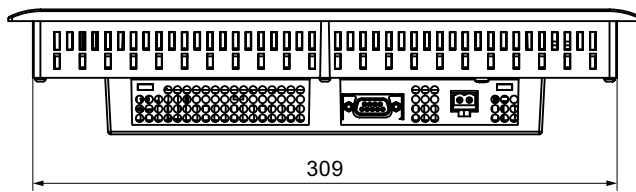

All dimensions in mm.

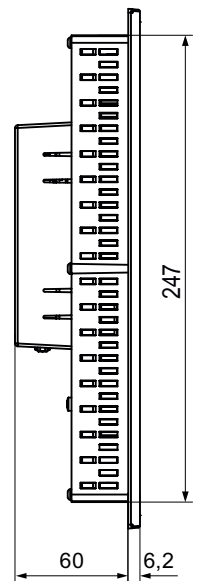
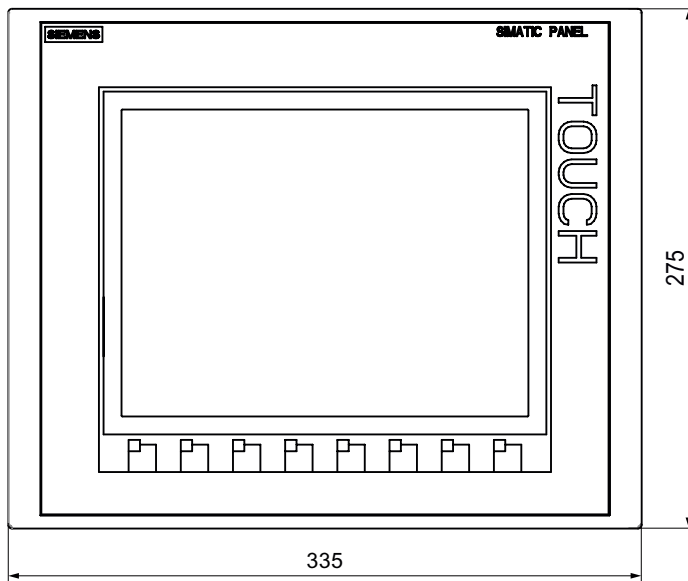

8.7.5 Dimensional drawing of KTP1000 PN Basic

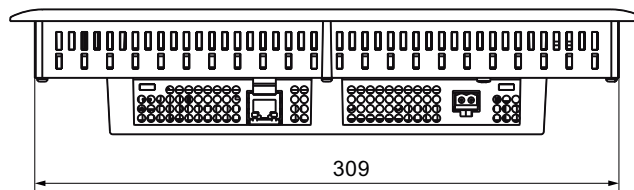

All dimensions in mm.

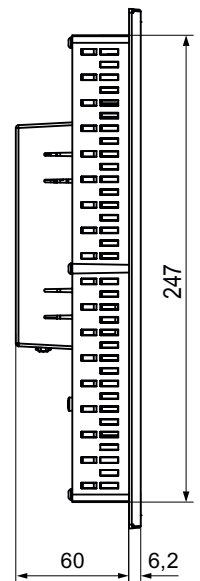
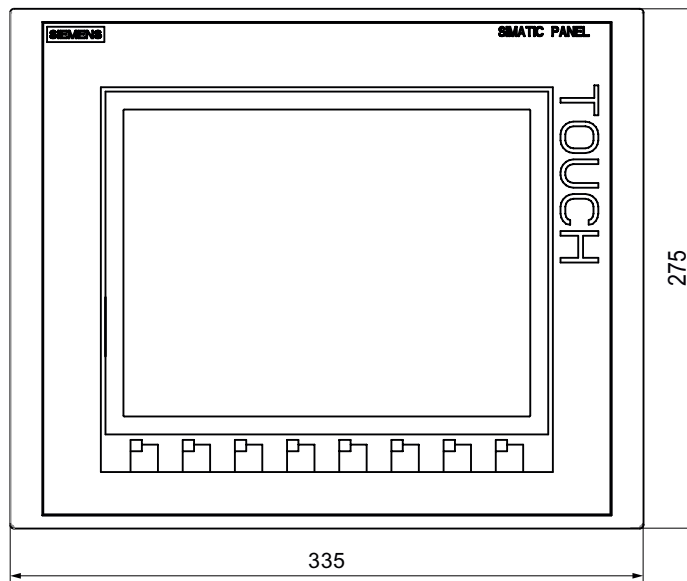

8.7.6 Dimensional drawing of TP1500 Basic

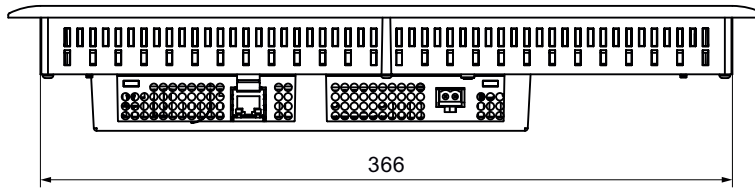

All dimensions in mm.

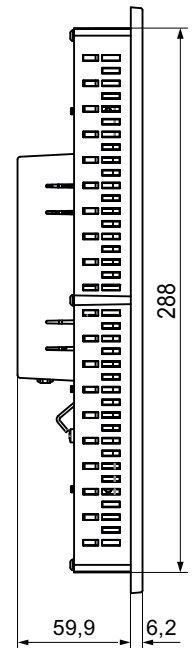
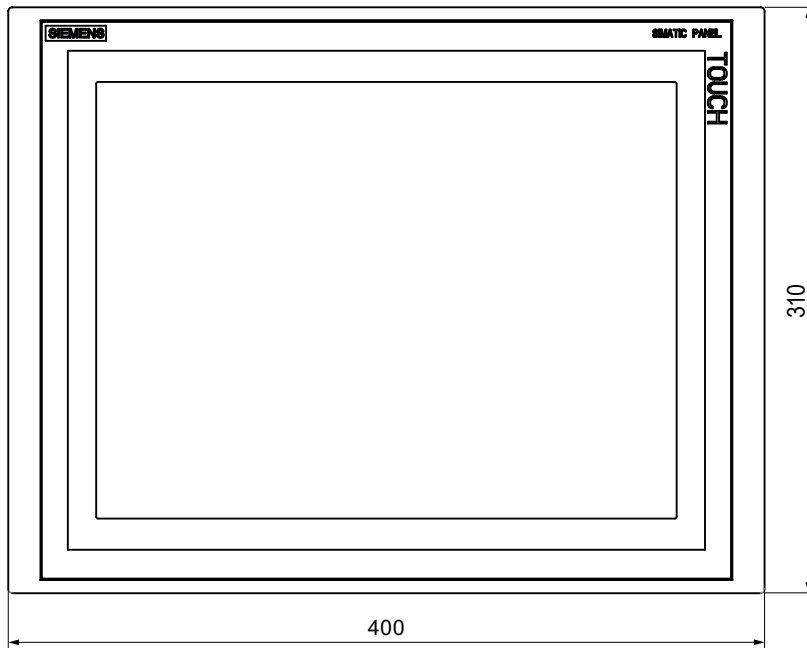

8.8 Specifications

8.8.1 Specifications of the KTP400 Basic and KTP600 Basic

Weight

	KTP400 Basic Mono PN	KTP600 Basic Mono PN	KTP600 Basic Color DP	KTP600 Basic Color PN
Weight without packaging	Approx. 320 g	Approx. 1070 g		

Display

	KTP400 Basic Mono PN	KTP600 Basic Mono PN	KTP600 Basic Color DP	KTP600 Basic Color PN
Type	LCD mono FSTN		LCD TFT	
Display area, active	76,79 mm x 57,59 mm (3,8")	115,2 mm x 86,4 mm (5,7")		
Resolution, pixels	320 x 240			
Colors, displayable	4 grayscales		256	
Contrast control	Yes		No	
Pixel error class according to DIN EN ISO 13406-2	-		II	
Backlighting	LED	CCFL		
Half brightness life time, typical	30.000 h	50,000 h		

Input device

	KTP400 Basic Mono PN	KTP600 Basic Mono PN	KTP600 Basic Color DP	KTP600 Basic Color PN
Type	Touch screen, analog resistive			
Function keys	4	6		
Labeling strips	Yes			

Memory

	KTP400 Basic Mono PN	KTP600 Basic Mono PN	KTP600 Basic Color DP	KTP600 Basic Color PN
Application memory	512 KB			

Interfaces

	KTP400 Basic Mono PN	KTP600 Basic Mono PN	KTP600 Basic Color DP	KTP600 Basic Color PN
1 x RS 422/RS 485	-	-	Max. 12 Mbps	-
1 x Ethernet	RJ45 10/100 Mbps	RJ45 10/100 Mbps	-	RJ45 10/100 Mbps

Supply voltage

	KTP400 Basic Mono PN	KTP600 Basic Mono PN	KTP600 Basic Color DP	KTP600 Basic Color PN
Rated voltage	+24 V DC			
Range, permissible	19.2 to 28.8 V (-20%, +20%)			
Transients, maximum permissible	35 V (500 ms)			
Time between two transients, minimum	50 s			
Current consumption				
<ul style="list-style-type: none"> • Typical • Constant current, maximum • Power on current surge I²t 	approx. 70 mA approx. 150 mA approx. 0,5 A ² s	approx. 240 mA approx. 350 mA approx. 0,5 A ² s	approx. 350 mA approx. 550 mA approx. 0,5 A ² s	
Fuse, internal	Electronic			

Miscellaneous

	KTP400 Basic Mono PN	KTP600 Basic Mono PN	KTP600 Basic Color DP	KTP600 Basic Color PN
Realtime clock	Yes, unbuffered			

8.8.2 Specifications of the KTP1000 Basic and TP1500 Basic

HMI device

	KTP1000 Basic Color DP	KTP1000 Basic Color PN	TP1500 Basic Color PN
Weight without packaging	Approx. 2.65 kg		Approx. 4.2 kg

Display

	KTP1000 Basic Color DP	KTP1000 Basic Color PN	TP1500 Basic Color PN
Type	LCD TFT		
Display area, active	211,2 mm x 158,4 mm (10,4")		304.1 mm x 228.1 mm (15")
Resolution, pixels	640 x 480		1024 x 768
Colors, displayable	256		
Brightness control	Yes		
Pixel error class according to DIN EN ISO 13406-2	II		
Backlighting	CCFL		
Half brightness life time, typical	50,000 h		

Input device

	KTP1000 Basic Color DP	KTP1000 Basic Color PN	TP1500 Basic Color PN
Type	Touch screen, analog resistive		
Function keys	8 function keys		No
Labeling strips	Yes		No

Memory

	KTP1000 Basic Color DP	KTP1000 Basic Color PN	TP1500 Basic Color PN
Application memory	1024 KB		

8.8 Specifications

Interfaces

	KTP1000 Basic Color DP	KTP1000 Basic Color PN	TP1500 Basic Color PN
1 x RS 422/RS 485	Max. 12 Mbps	-	
1 x Ethernet	-	RJ45 10/100 Mbps	

Supply voltage

	KTP1000 Basic Color DP	KTP1000 Basic Color PN	TP1500 Basic Color PN
Rated voltage	+24 V DC		
Range, permissible	19.2 to 28.8 V (-20%, +20%)		
Transients, maximum permissible	35 V (500 ms)		
Time between two transients, minimum	50 s		
Current consumption	approx. 600 mA		Approx. 800 mA
• Typical	approx. 1000 mA		Approx. 1000 mA
• Constant current, maximum	approx. 0.2 A ² s		Approx. 0.2 A ² s
• Power on current surge I ² t			
Fuse, internal	Electronic		

Miscellaneous

	KTP1000 Basic Color DP	KTP1000 Basic Color PN	TP1500 Basic Color PN
Realtime clock	Yes, unbuffered		

8.9 Functional Scope with WinCC flexible

The following tables show the objects that can be integrated in a project for a Basic Panel.

Alarms

Object	Specification	Basic Panels
Alarms	Number of discrete alarms	200
	Number of analog alarms	15
	Length of the alarm text	80 characters
	Number of tags in an alarm	Max. 8
	<i>Display</i>	<i>Alarm window, alarm view</i>
	<i>Acknowledge error alarm individually</i>	<i>Yes</i>
	<i>Acknowledge multiple error alarms simultaneously (group acknowledgement)</i>	<i>16 acknowledgment groups</i>
	<i>Edit alarm</i>	<i>Yes</i>
Alarm buffer	<i>Alarm indicator</i>	<i>Yes</i>
	Alarm buffer capacity	256 alarms
	Simultaneously queued alarm events	Max. 64
	<i>View alarm</i>	<i>Yes</i>
	<i>Delete alarm buffer</i>	<i>Yes</i>

Tags, values and lists

Object	Specification	KTP400 Basic, KTP600 Basic	KTP1000 Basic, TP1500 Basic
Tags	Quantity	128	256
<i>Limit value monitoring</i>	<i>Input/output</i>		<i>Yes</i>
<i>Linear scaling</i>	<i>Input/output</i>		<i>Yes</i>
Text lists	Quantity		150

Screens

Object	Specification	Basic Panels
Screens	Quantity	50
	Fields per screen	30
	Tags per screen	30
	Complex objects per screen (for example, bars)	30
	Template	Yes

Recipes

The specified values are maximum values and should not be used additive.

Object	Specification	Basic Panels
Recipes	Quantity	5
	Elements per recipe	20
	Data records per recipe	20

Safety

Object	Specification	Basic Panels
Safety	Number of user groups	50
	Number of users	50
	Number of authorizations	32

Info texts

Object	Specification	Basic Panels
Info texts	Length (no. of characters)	320
	For alarms	Yes
	For screens	Yes
	For screen objects (for example, for I/O field, switch, button, invisible button)	Yes

Additional functions

Object	Specification	Basic Panels Mono	Basic Panels Color
Screen settings	Touch screen calibration	Yes	Yes
	Brightness setting	-	Yes ¹⁾
	Contrast setting	Yes	-
Language change	Number of languages	5	
Graphic objects	Vector and pixel graphics	Yes	
Trend views	Quantity	max. 25	
Trends per view	Quantity	max. 4	
Text objects	Quantity	500	

¹⁾ Not for KTP600

Appendix

A.1 ESD guideline

Definition of ESD

All electronic modules are equipped with large-scale integrated ICs or components. Due to their design, these electronic elements are highly sensitive to overvoltage, and thus to any electrostatic discharge. These electronic components are therefore specially identified as ESDs.

Abbreviations

The following abbreviation is commonly used for electrostatic sensitive devices:

- EGB – Elektrostatisch Gefährdete Bauteile/Baugruppen (Germany)
- ESD – Electrostatic Sensitive Device (internationally recognized term)

Labeling

ESDs are labeled with the following symbol:



Electrostatic charging

CAUTION

Electrostatic charging

ESDs may be destroyed by voltages far below the level perceived by human beings. Voltages of this kind develop when a component or an assembly is touched by a person who is not grounded against static electricity. Usually, it is unlikely that damage to an ESD as a result of overvoltage is detected immediately but may become apparent only after a longer period of operation.

Prevent electrostatic charging of your body before you touch the ESD!

Anyone who is not connected to the electrical potential of their surroundings is subjected to electrostatic charging.

The following figure indicates the maximum electrostatic charge anyone is subjected to when coming into contact with the materials shown. These values correspond with specifications to IEC 801-2.

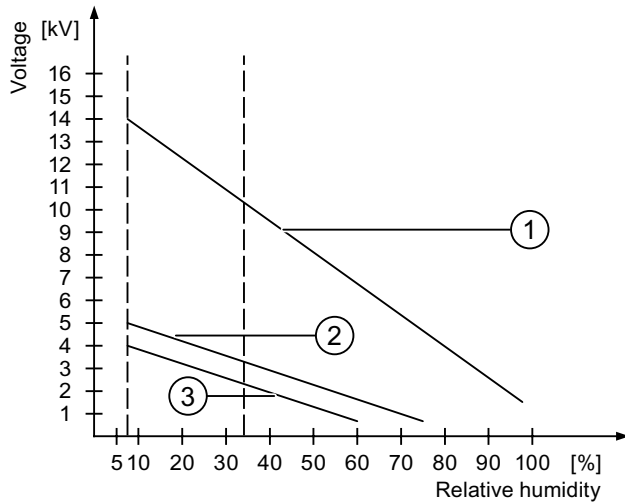

- ① Synthetic materials
- ② Wool
- ③ Antistatic materials such as wood or concrete

Protective measures against electrostatic discharge

CAUTION
Observe grounding measures When working with electrostatic sensitive devices, make sure that the person, the workplace and the packaging are properly grounded. This helps to avoid electrostatic charging.

As a rule, only touch the ESD if this is unavoidable, for example for maintenance. When you touch modules, make sure that you do not touch the pins on the modules or the PCB tracks. In this way, the discharged energy can not affect the sensitive devices.

Discharge electrostatic electricity from your body if you are performing measurements on an ESD. Do so by touching grounded metallic parts.

Always use grounded measuring instruments.

A.2 System events

System alarms on the HMI device provide information about internal states of the HMI device and PLC.

Note

System alarms are only indicated if an alarm window was configured. System events are output in the language currently set on your HMI device.

System event parameters

System events may contain encrypted parameters which are relevant to troubleshooting because they provide a reference to the source code of the runtime software. These parameters are output after the text "Error code:"

System alarms in the online help

A listing of all system alarms for your HMI device is provided in the WinCC flexible Online Help in the section "System alarms".

Abbreviations

ANSI	American National Standards Institution
CPU	Central Processing Unit
CSV	Comma Separated Values
CTS	Clear To Send
DC	Direct Current
DCD	Data Carrier Detect
DHCP	Dynamic Host Configuration Protocol
DIL	Dual-in-Line (electronic chip housing design)
DNS	Domain Name System
DP	Distributed I/O
DSN	Data Source Name
DSR	Data Set Ready
DTR	Data Terminal Ready
IO	Input and Output
ESD	Components and modules endangered by electrostatic discharge
EMC	Electromagnetic Compatibility
EN	European standard
ES	Engineering System
ESD	Components and modules endangered by electrostatic discharge
GND	Ground
HF	High Frequency
HMI	Human Machine Interface
IEC	International Electronic Commission
IF	Interface
IP	Internet Protocol
LED	Light Emitting Diode
MAC	Media Access Control
MOS	Metal Oxide Semiconductor
MPI	Multipoint Interface (SIMATIC S7)
MS	Microsoft
MTBF	Mean Time Between Failures
n. c.	Not connected
OP	Operator Panel
PC	Personal Computer
PG	Programming device
PPI	Point-to-Point Interface (SIMATIC S7)
RAM	Random Access Memory
PELV	Protective Extra Low Voltage
RJ45	Registered Jack Type 45

RTS	Request to send
RxD	Receive Data
SD Card	Security Digital Card
SELV	Safety Extra Low Voltage
SP	Service Pack
PLC	Programmable Logic Controller
STN	Super Twisted Nematic
Sub-D	Subminiature D (plug)
TAB	Tabulator
TCP/IP	Transmission Control Protocol/Internet Protocol
TFT	Thin Film Transistor
TTY	Teletype
TxD	Transmit Data
UL	Underwriter's Laboratory
USB	Universal Serial Bus
UPS	Uninterruptible power supply
WINS	Windows Internet Naming Service

Glossary

Acknowledge

Acknowledgment of an alarm confirms that it has been noted.

Alarm, acknowledgment

Acknowledgment of an alarm confirms that it has been noted.

Alarm, activated

Moment at which an alarm is triggered by the PLC or HMI device.

Alarm, deactivated

Moment at which the initiation of an alarm is reset by the PLC.

Alarm, user-specific

User-specific alarms report specific states of a plant that is interconnected with the HMI device via the PLC.

Automation system

An automation system is a PLC of the SIMATIC S7 product line, e.g. SIMATIC S7-300

Boot loader

The boot loader is used to start the operating system and is started automatically after power on of the HMI device. The Loader is displayed after the operating system has loaded.

Configuration PC

A configuration PC is a programming device or PC on which plant projects are created using an engineering software.

Configuration software

The configuration software is used to create projects for process visualization. WinCC flexible is such a configuration software, for example.

Display duration

Defines whether a system alarm is displayed on the HMI device and the duration of the display.

EMC

Electromagnetic compatibility is the ability of electrical equipment to function properly in its electromagnetic environment without influencing this environment.

Event

Incoming events trigger defined functions. Events can be configured. Events which can be assigned to a button include "Press" and "Release", for example.

Field

Area reserved in configured screens for the input and output of values.

Flash memory

Flash memory is a non-volatile memory with EEPROM chips that is implemented either as mobile storage medium, or as permanently installed memory module on the motherboard.

Function key

Function keys on the HMI device can be assigned user-specific functions. The functions assigned to those keys are defined in the engineering phase. The function key assignment can be specific to an active screen or not.

Half Brightness Life Time

Time period after which brightness is reduced to 50% of the original value. The specified value depends on the operating temperature.

HMI device

HMI devices are used to operate and monitor machinery and plants. The machine or plant states are visualized on the HMI device by means of graphic objects or signal lamps. The operator controls of the HMI device enable intervention in machine or plant processes and sequences.

HMI device image

The HMI device image is a file that can be transferred from the configuration PC to the HMI device. The HMI device image contains the operating system of the HMI device, including the elements of the Runtime software required for the executable project file.

I/O field

Enables the input or output of values on the HMI device and their transfer to the PLC.

Info text

A configured info text provides information about objects within a project. An alarm info text, for example, can contain information on the cause and troubleshooting of faults.

Object

An object is a project element such as a screen or an alarm. Objects are used to view or enter texts and values on the HMI device.

Operator control

An operator control is a project component that is used to enter values and trigger functions. A button is such an operator control.

Plant

General term referring to machinery, processing centers, systems, plants and processes which are operated and monitored using an HMI device.

PLC

PLC is a general term for devices and systems with which the HMI device communicates, e.g. SIMATIC S7.

PLC job

A PLC job triggers a function at the HMI device.

Process visualization

Denotes visualization of technical processes by means of text and graphic elements. Configured plant screens enable intervention in runtime plant processes by means of data input and output.

Project

A project is the result of a configuration using an engineering software. The project usually contains several screens with embedded system-specific objects, basic settings and alarms. A project configured in WinCC flexible is saved to a project file with the extension *.hmi.

There is a difference between an offline project on a configuration PC and an online executable project on an HMI device. A project can be available in more languages on the configuration PC than can be managed on the HMI device. The project on the configuration PC can also be set up for different HMI devices. However, on the HMI device you can only transfer the executable project that has been generated specifically for this HMI device.

Project file

Source file from which the executable project file for the HMI device is generated. The project file is usually not transferred and is retained on the configuration PC.

Project files have the extension *.hmi.

Project file, compressed

Compressed format of the project file. The compressed project file can be transferred in addition to the executable project file to the corresponding HMI device. The upload function must be activated accordingly on the configuration PC at the time of the transfer. The compressed project file is usually saved to an external memory card.

A compressed project file has the extension *.pdz.

Project file, executable

An executable project file is generated from the project file for a specific HMI device in the course of engineering. The executable project file is transferred to the associated HMI device where it is used to operate and monitor plants.

An executable project file has the extension "*.fwx".

Recipe

A recipe represent a combination of tags that form a fixed data structure. The configured data structure can be assigned data in the configuration software or on the HMI device and is then referred to as a data record. The use of recipes ensures that all data assigned to a data record is transferred synchronously to the PLC.

Runtime software

The Runtime software is a process visualization software which can be used to test projects on a configuration PC.

Screen

Mode of visualization of all logically associated process data of a plant. Visualization of the process data can be supported by means of graphic objects.

Screen object

Refers to objects such as rectangles, I/O fields, or alarm views which are configured for visualization or operation of the plant.

STEP 7

STEP 7 is the programming software for SIMATIC S7, SIMATIC C7 and SIMATIC WinAC PLCs.

STEP 7 Micro/WIN

STEP 7 Micro/WIN is the programming software for SIMATIC S7-200 PLCs.

Symbolic I/O field

Symbolic I/O fields are used for the input and output of values. A field contains a list of default entries from which one can be selected.

System alarms

System alarms are assigned the "System" alarm class. A system alarm reports internal states of the HMI device and of the PLC.

Tab order

The tab order defined in the course of project engineering determines the sequence for activating objects by pressing the <TAB> key.

Tags

A tag is a defined memory area that is used to read and write values. Those tags can be accessed from the PLC or using the HMI device. We distinguish between external tags (process tags) and internal tags, depending on whether or not the tag is interconnected with the PLC.

Transfer

Transfer of an executable project from the configuration PC to the HMI device.

"Transfer" mode

HMI device operating mode for transferring an executable project from the configuration PC to an HMI device.

Index

A

- Accessories, 19
- Ambient conditions
 - Climatic, 96
 - Mechanical, 95
 - Test, 96
- Approvals, 91

B

- Backup, 67, 71, 72, 74
 - With ProSave, 74
 - With WinCC flexible, 72
- Basic knowledge
 - Required, 3

C

- Care, 89
- CE approval, 91
- Checking
 - Conditions of use, 95
 - Package content, 23
 - Standards and approvals, 91
 - Transport and storage conditions, 94
- Clamping frame, 20
- Climatic
 - Storage conditions, 94
 - Transport conditions, 94
- Clock
 - KTP1000, TP1500 Basic, 108
 - KTP400, KTP600 Basic, 106
- Commissioning engineers, 3
- Compatibility conflict, 71
- Conductor cross-section
 - Equipotential bonding, 32
- Configuration phase, 65
- Configuring
 - MPI/Profibus Settings, 55
 - Network settings, 56
 - RS-422/485 interface, 40
- Configuring PC, 65
- Connecting
 - Configuration PC, 36
 - Equipotential bonding, 32

- PLC, 39
 - Power supply, 34
 - Programming device, 35
- Contact person, 6
- Control cabinet
 - Working on, 21
- Control panel
 - Opening, 53
 - Password protection, 53
- Control Panel
 - Overview, 54
- Converter
 - PC/PPI cable, 19
 - RS 422 to RS 232, 19
 - USB/PPI cable, 19
- C-Tick mark (Australia), 91

D

- Decimal places, 50, 52
- Degree of protection
 - Protection against ingress of solid foreign bodies, 97
 - Protection against water, 97
- DIP switch
 - Setting, 40
- Display
 - KTP1000, TP1500 Basic, 107
 - KTP400, KTP600 Basic, 105
- Disposal, 90
- Disturbance
 - Pulse-shaped, 93
 - Sinusoidal, 93
- Documentation
 - Additional, 6
 - Conventions, 4

E

- EC Declaration of Conformity, 91
- Elbow adapter, 19
- Electrical isolation, 98
- Electrical potential difference, 32
- Electrostatic charging, 111
- Electrostatic discharge
 - Electrostatic, 111
 - Precautions, 112
- EMC directive, 91

Emission, 22, 94
Enabling a data channel, 54
Equipotential bonding
 Cable, 32
 Connecting, 32
 Requirements, 32
 Wiring diagram, 33
ESD
 Abbreviations, 111
 Labeling, 111

F

Factory setting
 With ProSave, 86
 With WinCC flexible, 84
Functional scope
 Alarm buffer, 109
 Alarms, 109
 Graphic objects, 110
 Info text, 110
 Language change, 110
 Limit value monitoring, 109
 Recipes, 110
 Safety, 110
 Scaling, 109
 Screen settings, 110
 Screens, 109
 Tags, 109
 Text lists, 109
 Text objects, 110
 Trend views, 110

H

High frequency radiation, 21
HMI device
 Connecting, 30
 EMC-compatible installation, 92
 Mounting, 28
 Shutting down, 43
 Switching on, 42
 Technical specifications, 105, 107
 Testing, 42

I

Information
 Additional, 6
Initial startup, 65
Input device

KTP1000, TP1500 Basic, 107
KTP400, KTP600 Basic, 105
Installation as intended, 21
Insulation test, 97
Interfaces
 KTP1000, TP1500 Basic, 108
 KTP400, KTP600 Basic, 106
Internet
 Service, 6

L

Labeling
 Approvals, 92
 EC Declaration of Conformity, 91
Limit value check, 50, 52
List of abbreviations, 115

M

Maintenance, 89
Maintenance technicians, 3
Mechanical
 Ambient conditions, 95
 Storage conditions, 94
 Transport conditions, 94
Memory
 KTP1000, TP1500 Basic, 107
 KTP400, KTP600 Basic, 105
Mounting
 EMC-compatible, 92
 HMI device, 28
MPI/Profibus Settings, 54

N

Non-isolated plant configuration, 98

O

Office location, 6
Offline
 Operating mode, 66
 Test, 70
Online
 Operating mode, 66
 Test, 70
OP properties
 Device, 54
 Display, 54
 License, 54

- Touch, 54
- Operating instructions
 - Purpose of, 3
 - Scope, 3
- Operating mode, 66
 - Changing, 66
 - Offline, 66
 - Online, 66
 - Transfer, 66
- Operating system
 - Update using ProSave, 79, 83
 - Update using WinCC flexible, 78
 - Updating, 76, 80
 - Updating using WinCC flexible, 82
- Operators, 3

P

- Package content
 - Checking, 23
- Password properties, 54
- Password protection
 - Activating, 63
 - Deactivating, 63
- Password protection, 53, 54
- PC/PPI cable, 19
- PELV, 98
- Plant configuration
 - Non-isolated, 98
- PLC
 - Configuring the interface, 40
- Power failure, 71
- Precautions
 - Electrostatic discharge, 112
- Process control phase, 65
- Product illustrations, 4
- PROFIBUS bus connector, 19
- PROFINET RJ45 plug connector, 19
- Profinet Settings, 54
- Project
 - Offline testing, 70
 - Testing online, 70
 - Transferring, 65
- Protection class, 97
- Protective foil, 20

R

- Radiation
 - High frequency, 21
- Radio interference, 22
 - Emission, 94

- Rated voltage, 98
- Recommissioning, 65
- Recycling, 90
- Registered trademarks, 5
- Regulations for the prevention of accidents, 21
- Restore, 67, 71, 75
 - With ProSave, 75
- Restoring, 73
 - With WinCC flexible, 73
- RS 422 to RS 232 converter, 19
- RS-422/485 interface
 - Configuring, 40

S

- S7-200
 - Active node, 113
- Safe electrical isolation, 98
- Safety
 - Standards, 91
- Safety instruction
 - Compatibility conflict, 71
 - Data channel, 77, 81
 - Data loss, 76, 80
 - Electrostatic charging, 111
 - Equipotential bonding cable, 32
 - General, 22
 - High frequency radiation, 21
 - Observe grounding measures, 112
 - Power failure, 71
 - Preventing inadvertent operation, 89
 - Storage, 94
 - Transport, 94
 - unauthorized cleaning products, 89
 - Unintentional response, 89
 - Working on the control cabinet, 21
- Safety regulations, 21
- Screen keyboard
 - Alphanumerical, 49, 51
 - Key assignment, 49, 51
 - KTP400 Basic, 48
 - KTP600, KTP1000, TP1500 Basic, 51
 - Numerical, 50, 52
- Screen saver, 54
- Screen settings
 - Editing, 54
- Service
 - In the Internet, 6
- Service technicians, 3
- Shutting down
 - HMI device, 43
- Sound Settings, 54

- Storage conditions, 94
- Strain relief, 43
- Stripping, 34
- Supply voltage
 - KTP1000, TP1500 Basic, 108
 - KTP400, KTP600 Basic, 106
- Switching on
 - HMI device, 42
- System alarms
 - in the online help, 113
 - Parameters, 113

T

- Technical specifications
 - Display, 105, 107
 - Input device, 105, 107
 - Interfaces, 106, 108
 - Memory, 105, 107
 - Supply voltage, 106, 108
- Technical Support, 6
- Test
 - Electromagnetic Compatibility, 92
 - Power supply, 98
- Testing
 - HMI device, 42
- Trademarks, 5
- Training Center, 6
- Transfer, 65, 66, 67
 - Automatic, 68
 - Manual, 67
- Transfer settings, 54
- Transferring
 - Project, 65
- Transport conditions, 94

U

- UL approval, 92
- Update
 - Using ProSave, 79, 83
 - Using WinCC flexible, 78, 82
- Updating
 - Operating system, 76, 80
- Usage
 - Conditions, 95
 - With additional measures, 95
- USB/PPI cable, 19
- Use
 - In residential areas, 22
 - Industrial, 22

V

- Vibrations, 95

W

- Weight
 - KTP1000, TP1500 Basic, 107
 - KTP400, KTP600 Basic, 105
- Working on the control cabinet, 21