

Single Loop Controller SDC15

User's Manual

"Installation & Configurations"



Thank you for purchasing the Single Loop Controller SDC15.

This manual contains information for ensuring correct use of the SDC15. It also provides necessary information for installation, maintenance, and troubleshooting.

This manual should be read by those who design and maintain devices that use the SDC15.

Be sure to keep this manual nearby for handy reference.

RESTRICTIONS ON USE

This product has been designed, developed and manufactured for general-purpose application in machinery and equipment.

Accordingly, when used in applications outlined below, special care should be taken to implement a fail-safe and/or redundant design concept as well as a periodic maintenance program.

- Safety devices for plant worker protection
- Start/stop control devices for transportation and material handling machines
- Aeronautical machines
- Aerospace machines
- Control devices for nuclear reactors

Never use this product in applications where human safety may be put at risk.

REQUEST

Ensure that this User's Manual is handed over to the user before the product is used.

Copying or duplicating this User's Manual in part or in whole is forbidden. The information and specifications in this User's Manual are subject to change without notice.

Considerable effort has been made to ensure that this User's Manual is free from inaccuracies and omissions.

If you should find any inaccuracies or omissions, please contact Yamatake Corporation.

In no event is Yamatake Corporation liable to anyone for any indirect, special or consequential damages as a result of using this product.

SAFETY REQUIREMENTS



To reduce risk of electric shock which could cause personal injury, follow all safety notices in this documentation.



This symbol warns the user of a potential shock hazard where hazardous live voltages may be accessible.

- If the equipment is used in a manner not specified by the manufacturer, the protection provided by the equipment must be impaired.
- Do not replace any component (or part) not explicitly specified as replaceable by your supplier.
- All wiring must be in accordance with local norms and carried out by authorized and experienced personnel.
- A switch in the main supply is required near the equipment.
- Main power supply wiring requires a (T) 200mA, 250V fuse(s) (IEC 127).

EQUIPMENT RATINGS

Supply voltages:	100 to 240V (operating power supply voltage 85 to 264Vac)
Frequency:	50/60Hz
Power consumption:	12VA maximum

EQUIPMENT CONDITIONS

Do not operate the instrument in the presence of flammable liquids or vapors.

Operation of any electrical instrument in such an environment constitutes a safety hazard.

Temperature:	0 to 50°C
Humidity:	10 to 90%RH (no condensation)
Vibration:	2m/s ² (10 to 60Hz)
Over-voltage category:	Category II (IEC60364-4-443, EN664-1)
Pollution degree:	Pollution degree 2

EQUIPMENT INSTALLATION

The controller must be mounted into a panel to limit operator access to the rear terminal.

Specifications of common mode voltage: The common mode voltages of all I/O except for main supply and relay outputs are less than 33Vrms, 46.7V peak and 70Vdc.

APPLICABLE STANDARDS

EN61010-1, EN61326-1

SAFETY PRECAUTIONS

■ About Icons

Safety precautions are for ensuring safe and correct use of this product, and for preventing injury to the operator and other people or damage to property. You must observe these safety precautions. The safety precautions described in this manual are indicated by various icons.

As the following describes the icons and their meanings, be sure to read and understand the descriptions before reading this manual:



WARNING

Warnings are indicated when mishandling this product might result in death or serious injury to the user.





CAUTION

Cautions are indicated when mishandling this product might result in minor injury to the user, or only physical damage to this product.











■ Examples

	<p>Triangles warn the user of a possible danger that may be caused by wrongful operation or misuse of this product.</p> <p>These icons graphically represent the actual danger. (The example on the left warns the user of the danger of electric shock.)</p>
	<p>White circles with a diagonal bar notify the user that specific actions are prohibited to prevent possible danger.</p> <p>These icons graphically represent the actual prohibited action. (The example on the left notifies the user that disassembly is prohibited.)</p>
	<p>Black filled-in circles instruct the user to carry out a specific obligatory action to prevent possible danger.</p> <p>These icons graphically represent the actual action to be carried out. (The example on the left instructs the user to remove the plug from the outlet.)</p>







WARNING

	Do not disassemble the SDC15. Doing so might cause electric shock or faulty operation.
	Before wiring, or removing/mounting the SDC15, be sure to turn the power OFF. Failure to do so might cause electric shock.
	Do not touch electrically charged parts such as the power terminals. Doing so might cause electric shock.

CAUTION

	Use the SDC15 within the operating ranges recommended in the specifications (temperature, humidity, voltage, vibration, shock, mounting direction, atmosphere, etc.).
	Do not block ventilation holes. Doing so might cause fire or faulty operation.
	Wire the SDC15 properly according to predetermined standards. Also wire the SDC15 using specified power leads according to recognized installation methods. Failure to do so might cause electric shock, fire or faulty operation.
	Do not allow lead clippings, chips or water to enter the controller case. Doing so might cause fire or faulty operation.
	Firmly tighten the terminal screws at the torque listed in the specifications. Insufficient tightening of terminal screws might cause electric shock or fire.
	Do not use unused terminals on the SDC15 as relay terminals. Doing so might cause electric shock, fire, or faulty operation.
	We recommend attaching the terminal cover (sold separately) after wiring the SDC15. Failure to do so might cause electric shock, fire, or faulty operation.
	Use the relays within the recommended life. Failure to do so might cause fire or faulty operation.
	Use Yamatake Corporation's "SURGENON" if there is the risk of power surges caused by lightning. Doing so might cause fire or faulty operation.
	Do not make incorrect connections. If the cables are connected incorrectly, this might cause the unit to malfunction.
	The controller does not function for approximately 6 sec. after the power has been turned ON. Great care should be taken when the relay output from the controller is used as interlock signals.

CAUTION

	The part between the control output 1 and control output 2 is not isolated. When necessary, use an appropriate isolator.
	Do not connect multiple loader cables to multiple units from one personal computer. The current coming from other circuits might cause the PV value indication error to occur.
	Do not connect any terminating resistor to both ends of the communication path when performing the RS-485 wiring. Doing so might cause the communication to fail.
	Always mount a switch for shut-down of the main power of this unit in an easily accessible area of the operator when performing electric wiring of this unit. Additionally, connect a slow-action type (T) fuse having a rated current of 0.2A and rated voltage of 250V to the wiring for the instrument power supply of the AC power supply model. (IEC127)
	Do not operate the key with a propelling pencil or sharp-tipped object. Doing so might cause faulty operation.
	This unit incorporates the self-tuning function without use of control constant settings in addition to the ON/OFF control and conventional PID control. This self-tuning control monitors and studies the characteristics of the control subject even if the SP value is changed or external disturbance occurs in order to automatically calculate the control constants. This ensures stable control all the time.

Important Notice Prior to Use of This Unit

The protective film is adhered to the front console of this unit to protect the surface.

After the installation and wiring work has been completed, stick a scotch tape to the corner of the console and pull it out in the direction indicated by an arrow to peel off the protective film.

Handling Precautions

If you attempt to peel off the protective film with your fingernail, this might cause damage to the console.

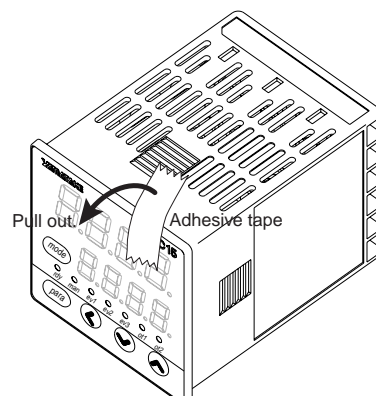

The Role of This Manual

Four different manuals in total are available for the Single Loop Controller SDC15 (hereafter referred to as "this unit"). Read appropriate manuals according to your requirements. If you do not have your required manual, contact Yamatake Corporation or its dealer.

Additionally, you can download necessary manuals from "<http://www.yamatake.com>".

The user level of this unit can be selected from three levels, "Simple configuration", "Standard configuration", and "High function configuration".

The functions you can set up only with "Simple configuration" are described in Single Loop Controller SDC15 User's Manual "Basic Operation" (CP-SP-1147E). If more advanced application is needed, refer to this manual.

This manual is intended for personnel who have already read Single Loop Controller SDC15 User's Manual "Basic Operation" and/or operated Yamatake's Single Loop Controller to fully understand its basic operation.

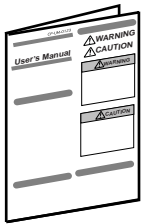

Single Loop Controller SDC15 User's Manual "Installation" Manual No. CP-UM-5287E

This manual is supplied with the product. Personnel in charge of design and/or manufacture of a system using this unit must thoroughly read this manual. This manual describes the safety precautions, installation, wiring, list of parameters, and primary specifications. For further information about operation, refer to other manuals, "Basic Operation" and/or "Installation & Configurations".

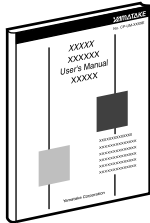

Single Loop Controller SDC15 User's Manual "Basic Operation" Manual No. CP-SP-1147E

This manual is optional (sold separately). The manual describes the functions you can set up only with "Simple configuration". Personnel in charge of design, manufacture, operation, and/or maintenance of a system using this unit must thoroughly read this manual. This manual describes the installation, wiring, major functions and settings, operating procedures, troubleshooting, and detailed specifications.

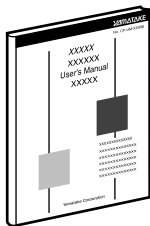

Single Loop Controller SDC15 User's Manual "Installation & Configurations" Manual No. CP-SP-1148E

This manual. This manual is optional (sold separately). The manual describes the hardware and all functions of this unit. Personnel in charge of design, manufacture, operation, and/or maintenance of a system using this unit and those in charge of communication software of a system using the communication functions of this unit must thoroughly read this manual. This manual also describes the installation, wiring, connections for communication, all functions and settings of this unit, operating procedures, communication with host station, such as personal computer, communication addresses, troubleshooting, and detailed specifications.

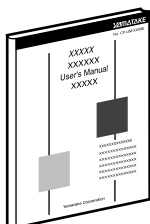

Smart Loader Package SLP-C35 for Single Loop Controller SDC15/25/26/35/36 User's Manual Manual No. CP-UM-5290E

This manual is supplied with the Smart Loader Package. The manual describes the software used to make various settings for SDC15/25/26/35/36 using a personal computer. Personnel in charge of design or setting of a system using SDC15/25/26/35/36 must thoroughly read this manual. The manual describes installation of the software into a personal computer, operation of the personal computer, various functions, and setup procedures.

Organization of This User's Manual

This manual is organized as follows:

Chapter 1. OVERVIEW

This chapter describes the applications, features, model selection guide, and part names and functions of this unit. Since the part names described in this chapter are used in the subsequent descriptions, the part names and functions of this unit must be understood correctly in this chapter.

Chapter 2. OUTLINE OF FUNCTIONS

This chapter describes the outline and operation flow of the functions of this unit.

Chapter 3. INSTALLATION

This chapter describes the environmental conditions, installation dimensions, installation procedures, and necessary tools when installing this unit.

Chapter 4. WIRING

This chapter describes the wiring procedures, wiring precautions, and connection examples.

Chapter 5. DETAILED DESCRIPTION OF EACH FUNCTION

This chapter describes each function of this unit in detail.

Chapter 6. LIST OF DISPLAYS AND SETTING DATA

This chapter lists up the display items of this unit and their contents.

Chapter 7. CPL COMMUNICATIONS FUNCTIONS

This chapter describes how to communicate this unit with a host unit, such as a personal computer or PLC through Yamatake's standard CPL communication using RS-485.

Chapter 8. MODBUS COMMUNICATIONS FUNCTIONS

This chapter describes how to communicate this unit with a host unit, such as a personal computer or PLC through MODBUS communication.

Chapter 9. LIST OF COMMUNICATION DATA

This chapter shows the list of communication data inside the memory of this unit.

Chapter 10. MAINTENANCE AND TROUBLESHOOTING

This chapter describes the maintenance and inspection of this unit, as well as troubleshooting.

Chapter 11. CALIBRATION

This chapter describes how to calibrate this unit in order to keep the accuracy and to safely operate this unit for an extended period of time.

Chapter 12. DISPOSAL

This chapter describes safety precautions and how to dispose of this unit when the unit is no longer used.

Chapter 13. SPECIFICATIONS

This chapter describes the general specifications, performance specifications, and optional parts of this unit.

Contents

SAFETY REQUIREMENTS	
SAFETY PRECAUTIONS	
Important Notice	
The Role of This Manual	
Organization of This User's Manual	
Conventions Used in This Manual	

Chapter 1. OVERVIEW

1-1 Overview.....	1-1
■ Model selection table	1-2
■ Accessories and optional parts	1-3
1-2 Part Names and Functions.....	1-4
■ Main body and console	1-4
■ Bottom panel	1-5
■ Rear panel	1-6

Chapter 2. OUTLINE OF FUNCTIONS

2-1 Input/Output Configuration	2-1
2-2 Key Operation	2-2
■ Standard key operation type	2-2
■ Special key operation type	2-4
■ Data setting procedures	2-6
■ [mode] key operating procedures	2-7
■ User level	2-8
2-3 Operation Modes	2-9

Chapter 3. INSTALLATION

■ Installation place.....	3-1
■ External Dimensions.....	3-2
■ Panel Cutout Dimensions.....	3-2
■ Mounting procedures	3-3

Chapter 4. WIRING

■ Terminal assignment label symbols	4-2
■ Wiring Precautions	4-2
■ Connection of open collector output to digital input.....	4-5
■ Connection of communication (RS-485) cable	4-5
■ Connection with SSR (solid state relay).....	4-7
■ Noise Preventive Measures	4-9

Chapter 5. DETAILED DESCRIPTION OF EACH FUNCTION

5-1	PV Input	5-1
■	PV input range type	5-2
■	Temperature unit	5-3
■	Cold junction compensation (T/C)	5-3
■	PV square root extraction dropout	5-3
■	Decimal point position	5-4
■	PV input range low limit/high limit	5-5
■	PV ratio and PV bias	5-5
■	PV filter	5-6
■	PV hold	5-6
■	PV low limit/high limit and PV low limit/high limit alarms	5-6
5-2	Mode.....	5-7
■	AUTO/MANUAL mode	5-7
■	RUN/READY mode	5-7
■	AT (Auto Tuning) stop/start	5-8
■	Release all DO (digital output) latches	5-8
■	Communication DI (digital input) 1	5-8
5-3	Control.....	5-9
■	Control method	5-11
■	Control action and Heat/Cool control	5-12
■	Special control outputs	5-12
■	MANUAL mode change	5-13
■	ON/OFF control	5-13
■	PID control	5-14
■	Heat/Cool control	5-15
■	ST (Self-tuning)	5-17
■	AT (Auto-tuning)	5-18
■	Just-FITTER	5-20
■	RationalLOOP	5-20
■	SP lag	5-20
5-4	AT (auto tuning) Function	5-21
■	Starting procedures	5-21
■	Stopping procedures	5-21
5-5	ST (Self-tuning) Function.....	5-24
■	Starting procedures	5-24
■	Stopping procedures	5-25
5-6	Precautions for ST (Self-tuning).....	5-26
5-7	SP	5-27
■	SP setup in operation display mode	5-28
■	LSP system group	5-28
■	LSP1 to 4	5-28
■	LSP group number	5-28
■	DI Assignment of LSP group selection	5-29
■	SP ramp unit	5-29
■	SP up ramp/down ramp	5-30
■	SP low limit/high limit	5-30

	■ DI Assignment of SP ramp enabled/disabled	5-31
5-8	DI (Digital Input) and Internal Contact	5-32
	■ Operation type	5-33
	■ Event channel def.	5-34
	■ Input bit function	5-34
	■ Input assign	5-35
	■ Polarity of input assign	5-36
	■ Polarity of input bit function	5-36
	■ DI Assignment setting with Smart Loader Package SLP-C35	5-37
5-9	Internal Event	5-38
	■ Operation	5-39
	■ Operation type	5-45
	■ Direct/reverse, standby, and EVENT state at READY	5-46
	■ Alarm OR, special OFF setup, and delay time unit	5-47
	■ Main setting, sub setting, and hysteresis	5-48
	■ ON delay and OFF delay	5-49
5-10	DO (Digital Output)	5-51
	■ MV1/MV2 process	5-52
	■ Operation type	5-53
	■ Output assign	5-54
	■ Polarity of output assign	5-56
	■ Polarity of output bit function	5-57
	■ Latch	5-57
	■ DO Assignment setting with Smart Loader Package SLP-C35	5-58
5-11	Application Examples	5-59
	■ Examples of applications using assign functions	5-59
5-12	Continuous Output	5-66
	■ Output range	5-66
	■ Output type	5-66
	■ Output scaling low limit/high limit	5-67
5-13	CT (Current Transformer) Input	5-68
	■ CT type	5-69
	■ CT output	5-69
	■ CT measurement wait time	5-69
5-14	Console Display and Key Operation	5-70
	■ Key operation type	5-70
	■ [mode] key function	5-70
	■ MODE display setup	5-71
	■ PV/SP display setup	5-72
	■ MV display setup	5-73
	■ EV display setup	5-74
	■ Timer remain time display setup	5-74
	■ CT display setup	5-75
	■ User level	5-75
	■ Communication monitor display	5-75
	■ User Function	5-76
	■ Key lock, communication lock, and loader lock	5-80
	■ Password	5-81

Chapter 6. LIST OF DISPLAYS AND SETTING DATA

6-1	List of Operation Displays	6-1
■	Operation displays	6-1
6-2	List of Parameter Setting Displays	6-3
■	Mode bank	6-3
■	SP bank	6-3
■	Event bank	6-4
■	PID bank	6-5
■	Parameter bank	6-6
■	Extended tuning bank	6-7
6-3	List of Setup Setting Displays	6-8
■	Setup bank	6-8
■	Event configuration bank	6-13
■	DI Assignment bank	6-16
■	DO Assignment bank	6-19
■	User Function bank	6-23
■	Lock bank	6-23
■	Instrument information bank	6-24

Chapter 7. CPL COMMUNICATIONS FUNCTIONS

7-1	Outline of Communications	7-1
■	Features	7-1
■	Setup	7-1
■	Communications procedures	7-2
7-2	Message Structure	7-3
■	Message structure	7-3
■	Data link layer	7-3
■	Application layer	7-5
7-3	Description of Commands	7-6
■	Continuous data read command (RS command)	7-6
■	Continuous data write command (WS command)	7-7
■	Fixed length continuous data read command (RD command)	7-8
■	Fixed length continuous data write command (WD command)	7-9
■	Fixed length random data read command (RU command)	7-10
■	Fixed length random data write command (WU command)	7-11
7-4	Definition of Word Addresses	7-12
7-5	Numeric Representation in the Application Layer	7-13
7-6	List of Termination Codes	7-14
7-7	Reception and Transmission Timing	7-15
■	Timing specifications for instruction and response message	7-15
■	RS-485 driver control timing specifications	7-15
7-8	Cautions when Making Communications Programs for the Master Station	7-16
■	Example of communications program	7-16

Chapter 8. MODBUS COMMUNICATIONS FUNCTIONS

8-1	Outline of Communications.....	8-1
■	Features	8-1
■	Setup	8-1
■	Communications procedures	8-2
8-2	Message Structure.....	8-3
■	Message structure	8-3
■	Command type	8-6
■	Other specifications	8-6
8-3	Description of Commands.....	8-7
■	Read command (03H)	8-7
■	Write command (10H)	8-9
8-4	Specifications Common with CPL Communications Function.....	8-11
■	Definition of word addresses	8-11
■	Numeric representation	8-11
■	RS-485 driver control timing specifications	8-11

Chapter 9. LIST OF COMMUNICATION DATA

■	List of communication data	9-1
---	----------------------------------	-----

Chapter 10. MAINTENANCE AND TROUBLESHOOTING

■	Maintenance	10-1
■	Alarm displays and corrective action.....	10-1
■	Operation in case of alarm occurrence	10-2

Chapter 11. CALIBRATION

■	Starting the calibration	11-1
■	Exiting the calibration	11-1
■	Cautions before starting the calibration	11-2
■	Measuring instruments required for calibration	11-2
■	Calibration procedures	11-2

Chapter 12. DISPOSAL

Chapter 13. SPECIFICATIONS

■	Specifications	13-1
■	Accessories and optional parts.....	13-4

Appendix

Glossary Appendix-1

Index

Conventions Used in This Manual

The following conventions are used in this manual:

Handling Precautions

: Handling Precautions indicate items that the user should pay attention to when handling the SDC15.



: This indicates the item or page that the user is requested to refer to.

Note

: Notes indicate useful information that the user might benefit by knowing.

(1), (2), (3) : The numbers with the parenthesis indicate steps in a sequence or indicate corresponding parts in an explanation.

[para], [mode] etc. : These indicate keys on the keyboard of this unit, and messages and menus that appear on the personal computer screen.

>> : This indicates the operation results and the status after operation.

● Numeric value and character display on LED

Numeric values The 7-segment LED expresses numeric values as follows:

0		1		2		3		4	
5		6		7		8		9	

Alphabetical characters The 7-segment LED expresses alphabetical characters shown below. There are some alphabetical characters, which are not displayed on the LED.

A		B		C		D		E	
a		b		c		d		e	
F		G		H		I		J	
f		g		h		i		j	
K		L		M		N		O	
k		l		m		n		o	
P		Q		R		S		T	
p		q		r		s		t	
U		V		Y		Z		-	
u		v		y		z			

Handling Precautions

As shown above, numeric value "2" and alphabetic character "Z" are shown in the same manner.

Accordingly, numeric value "5" and alphabetic character "S", as well as numeric value "9" and alphabetic character "Q" are also shown in the same manner.

Chapter 1. OVERVIEW

1 - 1 Overview

This unit is a compact controller having a mask of 48 X 48 mm and provides the following features:

- The depth is only 60 mm, providing the excellent space-saving.
- The front panel is only 2 mm thick. This ensures the excellent thin design.
- The display panel is large. This provides excellent visibility.
- [mode] key, [para] key, and digit-shift keys are provided on the front panel. This ensures easy setup operation.
- Various input types are available, thermocouples (K, J, E, T, R, S, B, N, PLII, WRe5-26, DIN U, DIN L), RTDs (Pt100, JPt100), current signals (4 to 20mA_{dc}, 0 to 20mA_{dc}), and voltage signals (0 to 1V_{dc}, 1 to 5V_{dc}, 0 to 5V_{dc}, and 0 to 10V_{dc}).
- For control outputs, relay, voltage pulse, and current output are provided. Additionally, these control outputs can be combined for the 2nd control output.
- The unit can be made applicable to the heat/cool control using the 2nd control output and/or event relay.
- ON/OFF control, fixed PID, and self-tuning control can be performed.
- In addition to the PID control, two algorithms, RationalLOOP and Just-FiTTER, are mounted. This ensures excellent controllability.
- With optional functions, a combination among 3- or 2-event points (independent contacts), 2-point CT input, 2-point digital input, and/or RS-485 can be selected.
- The personal computer loader port is provided as standard function. The setup can be made easily with use of the personal computer loader.
- Use of optional Smart Loader Package (SLP-C35) makes it possible to easily perform the read/write operation of the parameters. In addition to the table format setup, the operation and control status can be monitored using the trend display. This unit can be operated without use of program on the host unit.
- The unit is applicable to the IEC directive and the CE marking is put on the unit.
(Applicable standards: EN61010-1 and EN61326-1)
- The unit is applicable to the UL standard. (File No. E96090)

■ Model selection table

The following shows the model selection table of this unit:

Basic model No.	Mounting	Control output	PV input	Power supply	Option	Additional treatment	Specifications	
C15								
(Note 4)	T						Panel mount type	
	S						Socket mount type	
(Note 2)		R0					Control output 1	Control output 2
		V0					Relay contact output	None
(Note 1)		VC					Voltage pulse output (for SSR drive)	None
(Note 1)		VV					Voltage pulse output (for SSR drive)	Current output
(Note 1)		C0					Voltage pulse output (for SSR drive)	Voltage pulse output (for SSR drive)
		CC					Current output	None
			T				Current output	Current output
			R				Thermocouple input (K, J, E, T, R, S, B, N, PL II, WRe5-26, DIN U, DIN L)	
			L				RTD input (Pt100/JPt100)	
				A			DC voltage/DC current input (0 to 1Vdc, 1 to 5Vdc, 0 to 5Vdc, 0 to 10Vdc, 0 to 20mAdc, 4 to 20mAdc)	
				D			AC Model (100 to 240Vac)	
					00		DC Model (24Vac/24 to 48Vdc)	
					01		None	
					02		Event relay output: 3 points	
			(Note 1)	(Note 3)	03		Event relay output: 3 points Current transformer input: 2 points Digital input: 2 points	
			(Note 1)	(Note 3)	04		Event relay output: 3 points Current transformer input: 2 points RS-485 communication	
			(Note 5)		05		Event relay output: 2 points (independent contact)	
			(Note 1)		06		Event relay output: 2 points (independent contact) Current transformer input: 2 points Digital input: 2 points	
			(Note 3)	(Note 5)				
			(Note 1)				Event relay output: 2 points (independent contact) Current transformer input: 2 points RS-485 communication	
			(Note 3)	(Note 5)				
Note 1.	Can not be selected for the C15S.					00	No additional processing	
Note 2.	Only 1a contact is applicable for C15S					D0	Inspection Certificate provided	
Note 3.	Current transformer sold separately					Y0	Complying with the traceability certification	
Note 4.	Socket sold separately							
Note 5.	Can not be selected for the DC Model.							

■ Accessories and optional parts

Name	Model No.
Mounting bracket (for C15T)	81446403-001 (Accessory)
Gasket	81409657-001 (Accessory)
Current transformer (5.8mm hole dia.)	QN206A
Current transformer (12mm hole dia.)	QN212A
Socket (for C15S)	81446391-001
Hard cover	81446442-001
Soft cover	81446443-001
Terminal cover	81446898-001
Smart Loader Package	SLP-C35J50
L-shaped plug adaptor	81441057-001

1 - 2 Part Names and Functions

■ Main body and console

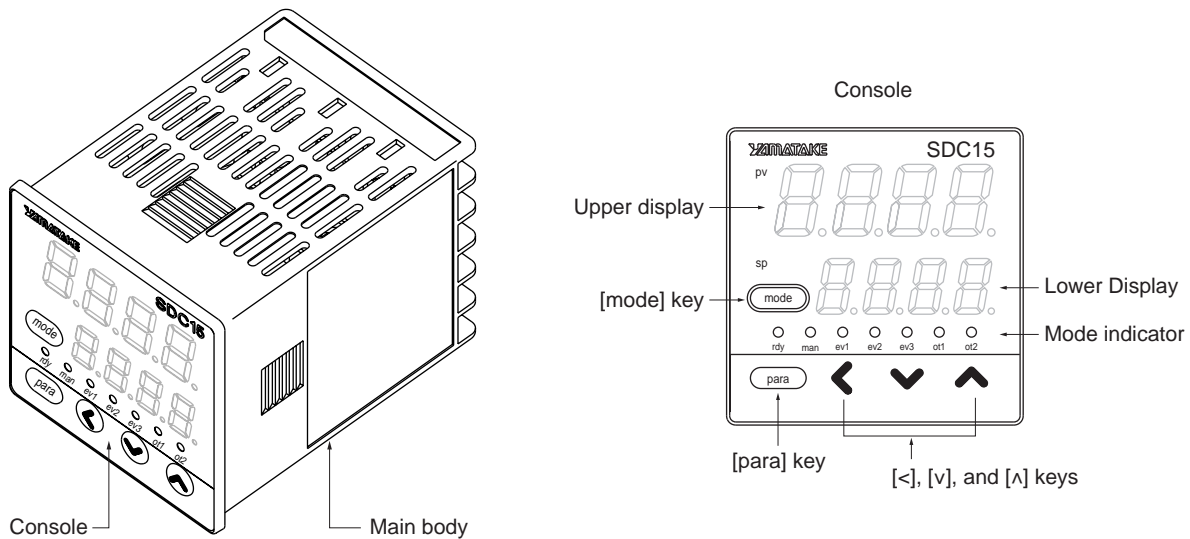

Main body: Contains the electric circuit for I/O signals of measuring instruments, CPU, and memory.

Console: Contains the display panel showing numeric value and status, and operation keys.

● Detailed description of console

[mode] key

When this key is kept pressed for 1 sec. or longer in the operation display mode, any of the following operations, which have been set previously, can be performed:

- AUTO/MANUAL mode selection
- RUN/READY mode selection
- AT (Auto Tuning) start/stop selection
- LSP (Local SP) group selection
- Release all DO (Digital Output) latches
- ON/OFF selection of communication DI (Digital Input) 1

When pressing the [mode] key in the setup display mode, the display is changed to the operation display.

[para] key

This key is used to change the display item.

When this key is kept pressed for 2 sec. or longer in the operation display mode, the display is then changed to the setup display.

<, [v], [^] keys

These keys are used to increase or decrease the numeric value, or to shift the digit.

Upper display

This display shows the PV value or the name of each display item (display value or set value). If an alarm occurs in the operation display mode, the normal display and alarm code are displayed alternately.

The decimal point at the right end digit shows AT (auto tuning) or ST (self-tuning) status. The decimal point flashes twice repeatedly during execution of AT while it flashes once repeatedly during execution of ST.

Lower display

This display shows the SP value, or the display value or set value of each display item. The decimal point at the right end digit shows the communication status.

Mode indicators

- [rdy]: RUN/READY mode indicator. Lights when READY
- [man]: AUTO/MANUAL mode indicator. Lights when MANUAL
- [ev1], [ev2], [ev3]: Event 1 to 3 output indicator. Lights when event relays are ON.
- [ot1], [ot2]: Control 1 to 2 output indicator. Lights when the control output is ON. The indicators are always lit when the current output is used.

! Handling Precautions

- To select the LSP group using the [mode] key, it is necessary to set a value of "2" or more in [LSP system group].
- To show the communication status using the decimal point at the right end digit on the lower display, select "High function configuration" and make the [LED monitor] settings.
- Do not operate the key with a sharp object (such as tip of mechanical pencil or needle). Doing so might cause the unit to malfunction.

■ Bottom panel

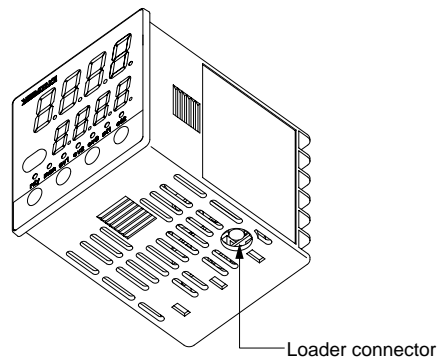

Loader connector: This connector is connected to a personal computer using the dedicated cable supplied with the Smart Loader Package.

■ Rear panel

● C15T (Panel mount type)

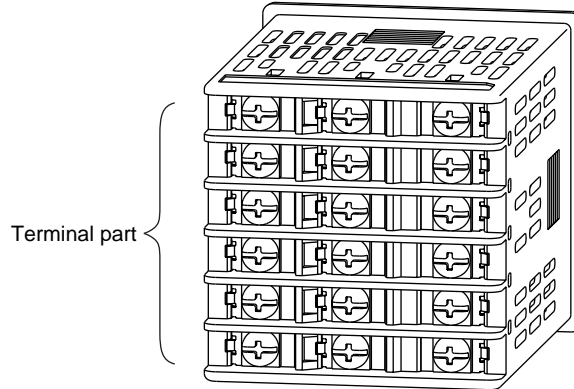

Terminal part: The power supply, input, and output are connected to the terminals. The M3 screw is used. When connecting to the terminal, always use a correct crimp terminal suitable for the M3 screw. The tightening torque of the terminal screw is 0.4 to 0.6N·m.

● C15S (Socket mount type)

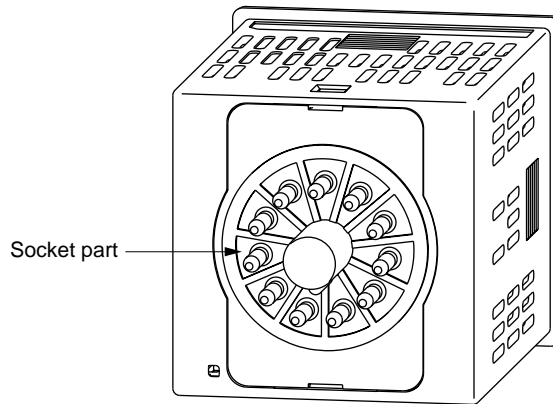

Socket part: This socket is inserted into the optional socket. The power supply, input, and output are connected from the socket. When performing the wiring from the socket, always use a correct crimp terminal suitable for the M3.5 screw. The tightening torque of the socket terminal screw is 0.78 to 0.98N·m or less.

Chapter 2. OUTLINE OF FUNCTIONS

2 - 1 Input/Output Configuration

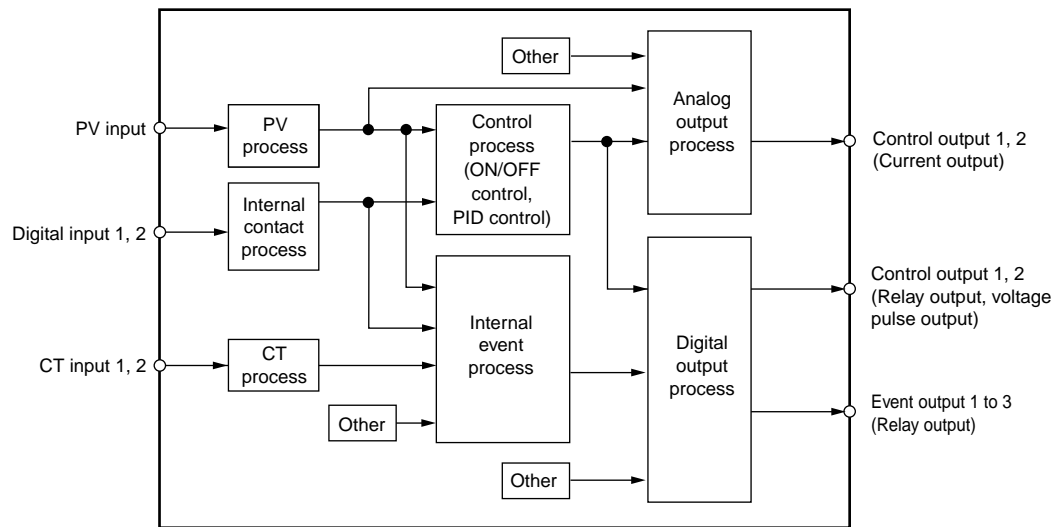

- **PV input**

Sensor or range is selected for the PV input. The selection range may vary depending on the input type of the model (T: Thermocouple, R: RTD, L: DC current, DC voltage).

- **Control output**

When the control output type of the model is "R: Relay" or "V: Voltage pulse", the control output becomes the ON-OFF control output or time proportional output. When the time proportional output is used, the time proportioning cycle time can be set. When the control output type of the model is "C: Current", the control output becomes the continuous output (analog output). When the model has two control outputs, the heat/cool control can be used only with "Simple configuration".

- **Event output**

When the model provides the event, the alarm or control mode set in [Event type] can be output as DO (digital output).

- **DI (digital input)**

When the model provides the DI, the function set with the DI assignments can be selected.

- **CT (current transformer) input**

When the model provides the CT input, the heater burnout alarm can be output from the event output.

2 - 2 Key Operation

Various displays or settings can be called up on the console through key operation.

Two kinds of general key operation flows are provided, standard key operation type and special key operation type.

A desired key operation type can be selected using the setup setting.

- Standard key operation type: Key operation similar to that of the conventional model SDC10.
- Special key operation type: A part of key operation of the conventional model SDC30 is added to that of the conventional model SDC10.

The following describes the general flow of each key operation type:

■ Standard key operation type

When the key operation mode/type of the setup setting "C71" is set at "0", the standard key operation type is selected.

The display and setting data of the standard key operation type are arranged as shown in the following tree-structure:



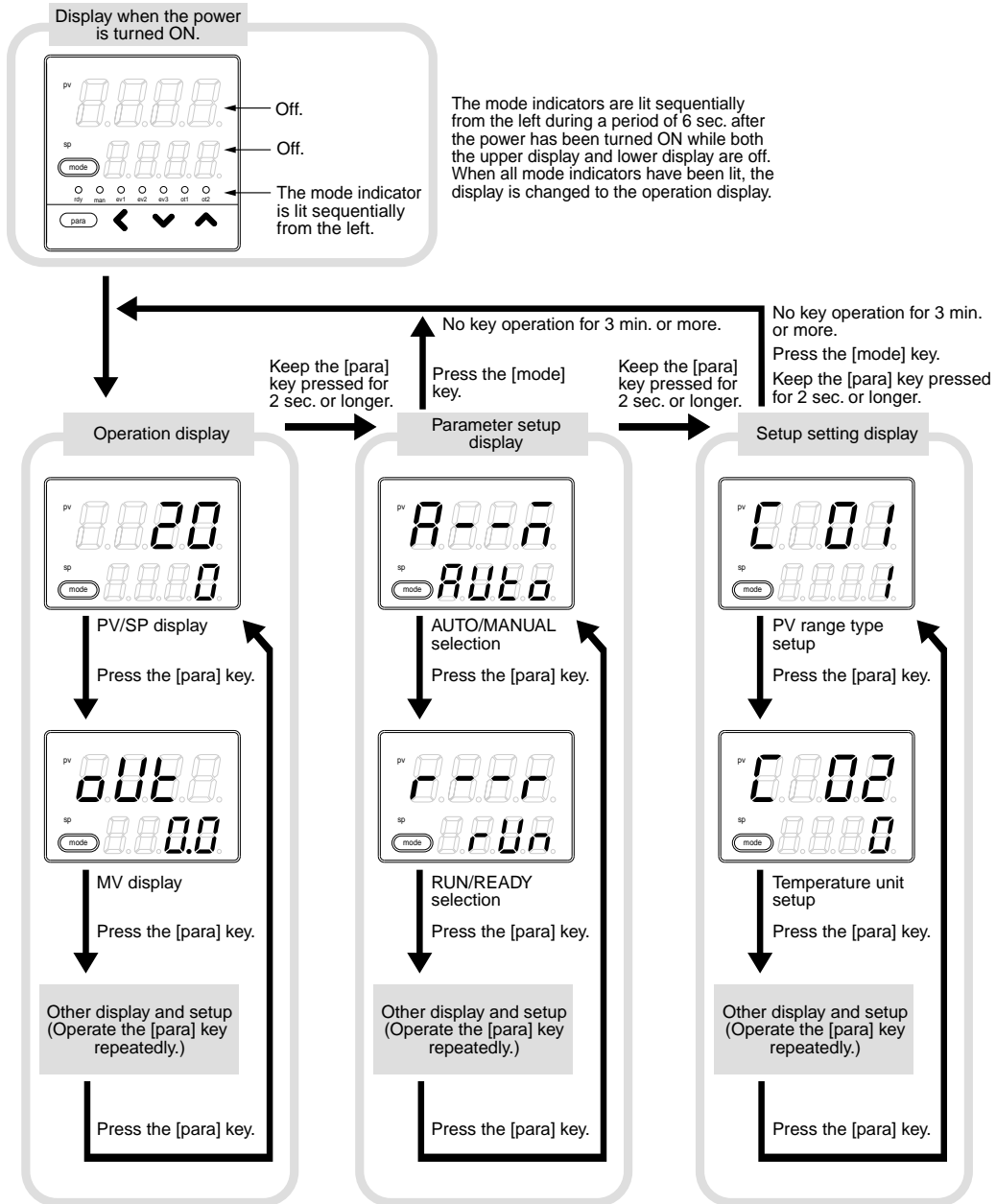

The display and setup status shown above are examples for explanation. Therefore, some displays or settings are not shown actually according to the model and/or setup contents.

! Handling Precautions

- For details about display and setup contents of the operation display, parameter setting display, and setup setting display, refer to
 - ➔ 6-1 List of Operation Displays (on page 6-1),
 - 6-2 List of Parameter Setting Displays (on page 6-3) and
 - 6-3 List of Setup Setting Displays (on page 6-8).
- When pressing the [<] key with the [para] key kept pressed instead of pressing of the [para] key, various displays and settings can be operated in the reverse order. However, the operation that both the [para] key and [<] key are kept pressed for 2 sec. or longer, is invalid.

■ Special key operation type

When the key operation mode/type of the setup setting "C71" is set at "1", the special key operation type is selected.

The display and setting data of the special key operation type are arranged as shown in the following tree-structure:

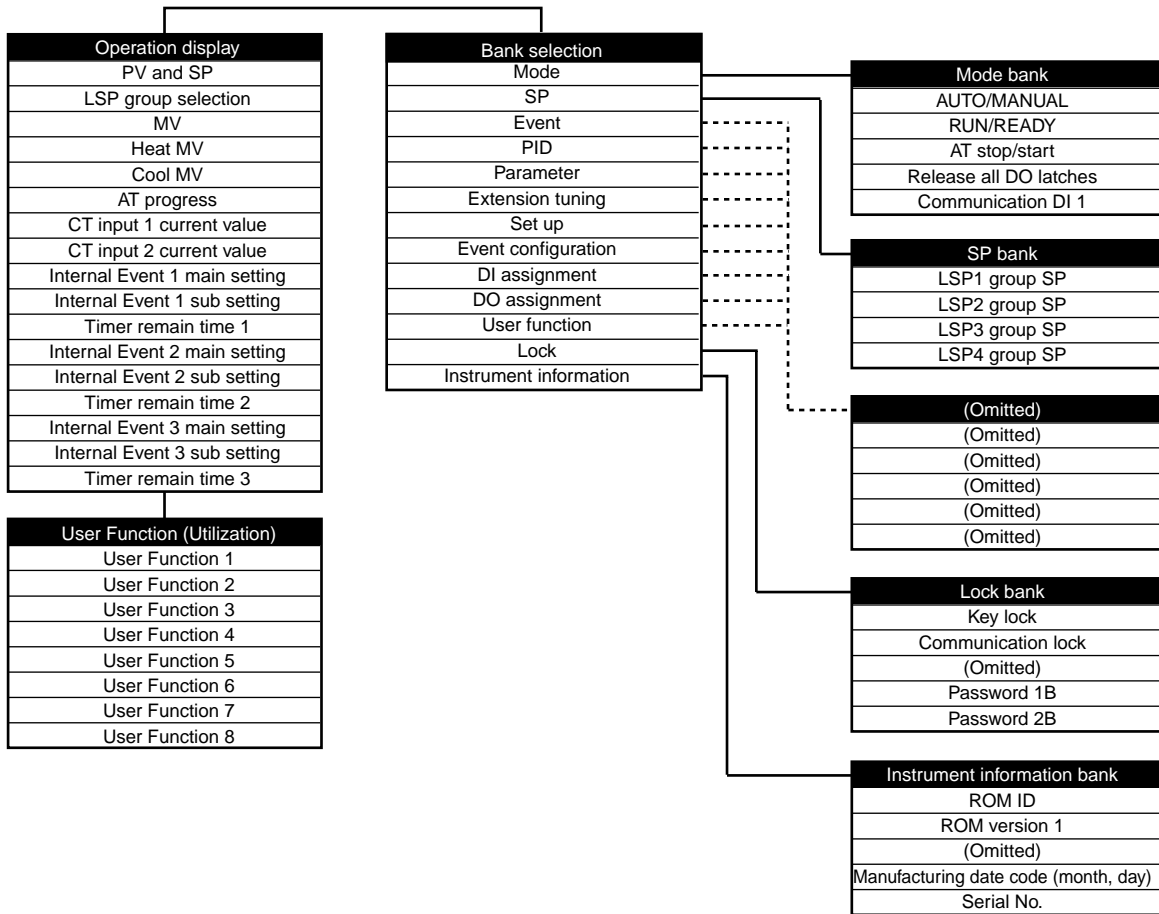

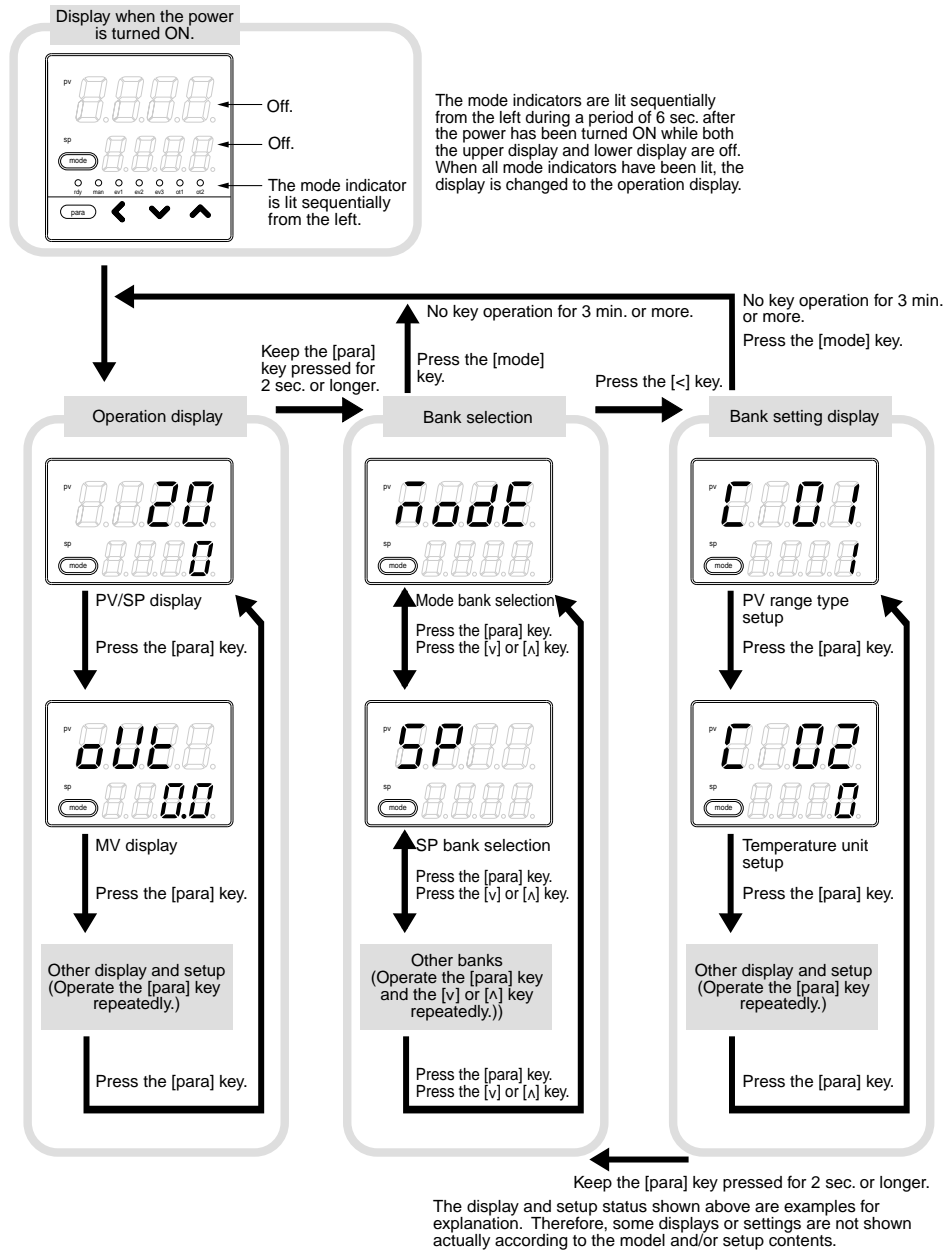

! Handling Precautions

- For details about display and setup contents of the operation display, bank selection display, and bank setting display, refer to
 - ☞ 6-1 List of Operation Displays (on page 6-1),
 - 6-2 List of Parameter Setting Displays (on page 6-3) and
 - 6-3 List of Setup Setting Displays (on page 6-8).
 In the lists shown above, a bank belonging to each setting item is described.
- When pressing the [<] key with the [para] key kept pressed instead of pressing of the [para] key in the operation display or setting item display mode, various displays and settings can be operated in the reverse order. However, the operation becomes invalid that both the [para] key and [<] key are kept pressed for 2 sec. or longer.

■ Data setting procedures

(1) Operate the [para] key to display desired data to be set.

(How to operate the [para] key is described in the previous section, "Flow of general key operation".)

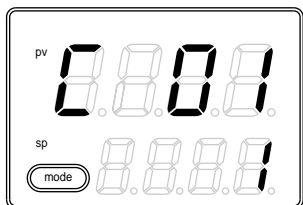

(This Figure shows the display when setting the PV range type of the setup setting [C01].)

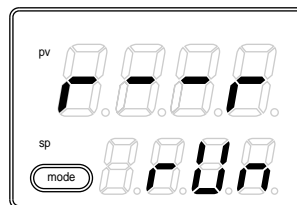

(This Figure shows the display when setting the RUN/Ready selection in the parameter setting [r...r].)



(2) Press any of the [<], [v], and [^] keys.

>> When the display No. 2 shows a numeric value, the 1st digit starts flashing. Additionally, when the display No. 2 shows a character string, the entire character string starts flashing.

When a numeric value is displayed, the value can be increased or decreased or the flashing digit can be moved using the [<], [v], or [^] key.

When a character string is displayed, the entire flashing character string can be changed using the [v] or [^] key.

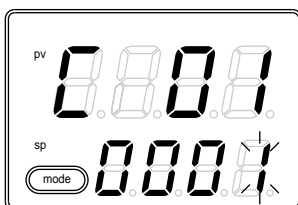

(This Figure shows the display when the 1st digit of "0001" is flashing.)

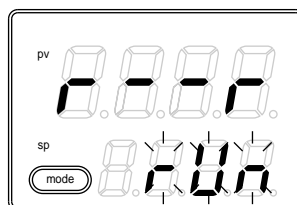

(This Figure shows the display when the entire character string "rUn" is flashing.)



(3) Release the key and wait for a while.

>> After 2 sec. have elapsed, the flashing display is stopped, and then the data you have changed is set.

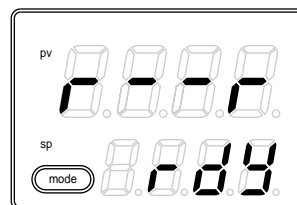

❗ Handling Precautions

- If the data does not start flashing even though the [<], [v], or [^] key is pressed, this data cannot be changed.

For example, when the RUN/READY is assigned in the DI Assignment, RUN/READY cannot be selected using the key on the front panel.

- If the character string cannot be changed using the [v] key while the entire character string is flashing, press the [^] key. On the contrary, if the character string cannot be changed using the [^] key, press the [v] key.
- When pressing the [para] key while the display is flashing, the next data is displayed without changing of the data. Additionally, when pressing the [mode] key while the display is flashing, the display is returned to the operation display without changing of the data.
- The MV (manipulated variable) display in the MANUAL mode continues the flashing status even after pressing of the key has been stopped. At this time, the flashing value is output as MV.

■ [mode] key operating procedures

When the [mode] key is kept pressed for 1 sec. or longer on the operation display, the selection operation, which has been set using the [mode] key function (C72) of the setup setting, can be performed.

The Figure on the right shows an example that the [mode] key is pressed in the RUN/READY selection (C72 = 2) setting.

- (1) If the current mode is the READY mode when the PV/SP is shown on the operation display, the character string "rUn" on the display No. 2 starts flashing.
- (2) When the [mode] key is kept pressed for 1 sec. or longer, the READY mode is changed to the RUN mode and the flashing of the character string "rUn" is stopped.
- (3) When pressing of the [mode] key is stopped, the display is returned to the PV/SP display.

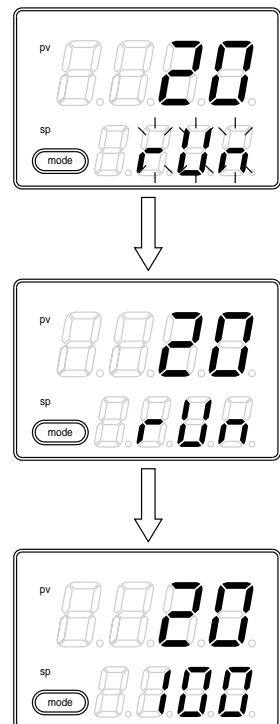

! Handling Precautions

- If the MODE key function of the setup setting is set disabled (C72 = 0) or if the set selection operation is invalid, the selection operation cannot be performed using the [mode] key.
- When pressing the [mode] key on the parameter setting display or setup setting display instead of the operation display, the display is returned to the operation display. However, even though the [mode] key is kept pressed continually, the selection operation cannot be performed. In this case, stop pressing the key once, and then press the [mode] key.

■ User level

The user level of this unit can be selected from three levels, "Simple configuration", "Standard configuration", and "High function configuration" using the user level of the setup setting "C79".

For details,

 refer to Chapter 6, LIST OF DISPLAYS AND SETTING DATA.

Handling Precautions

Even though the user level is changed, the functions other than setting display cannot be changed. The user level is set to "Standard configuration" or "High function configuration" and more advanced functions are set. After that, when the setup is returned to "Simple configuration", this function setup cannot be displayed, but the function itself is operated.

2 - 3 Operation Modes

The following shows the transition of operation modes:

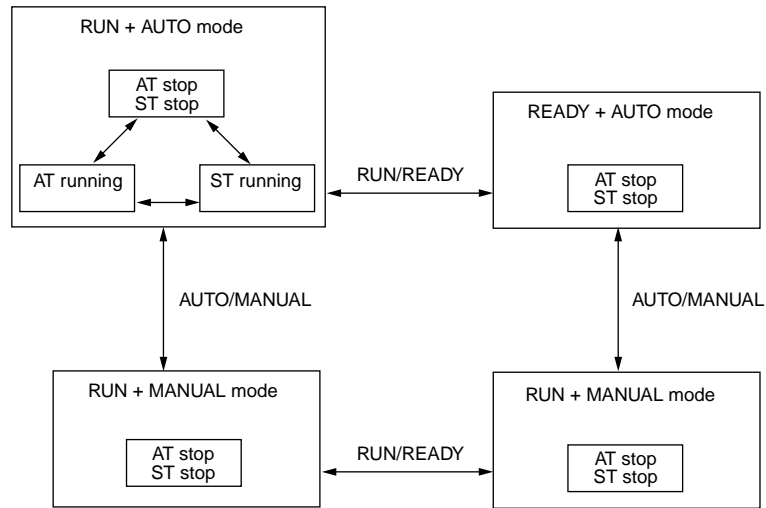

RUN: Control status

READY: Control stop status

AUTO: Automatic operation (This unit automatically determines the MV values.)

MANUAL: Manual operation (The MV values are operated manually.)

AT: Auto tuning (The PID constants are set automatically using the limit cycle.)

ST: Self-tuning (The PID constants are set automatically while the control is kept continuously.)

Chapter 3. INSTALLATION

CAUTION



Use the SDC15 within the operating ranges recommended in the specifications (temperature, humidity, voltage, vibration, shock, mounting direction, atmosphere, etc.).
Failure to do so might cause fire or faulty operation.



Do not block ventilation holes.
Doing so might cause fire or faulty operation.

■ Installation place

Install the controller in the following locations:

- Common mode voltage for I/O excluding the power supply and relay contact output:
The voltage to the grounding line must be as follows:
AC: 33V r.m.s. or less and 46.7V peak or less
DC: 70Vdc or less
- Not high or low temperature/humidity.
- Free from sulfide gas or corrosive gas.
- Less dust or soot.
- Appropriately processed locations to prevent direct sunlight, wind or rain.
- Less mechanical vibration and shock.
- Not close to the high voltage line, welding machine or electrical noise generating source.
- The minimum 15 meters away from the high voltage ignition device for a boiler.
- Less effect by the magnetic.
- No flammable liquid or gas.

External Dimensions

● C15T (Panel Mount type)

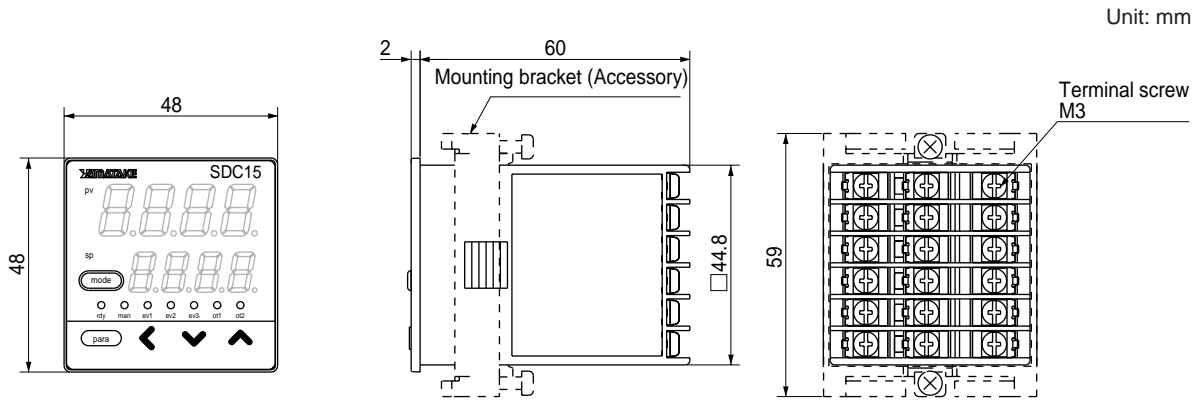

● C15S (Socket Mount type)

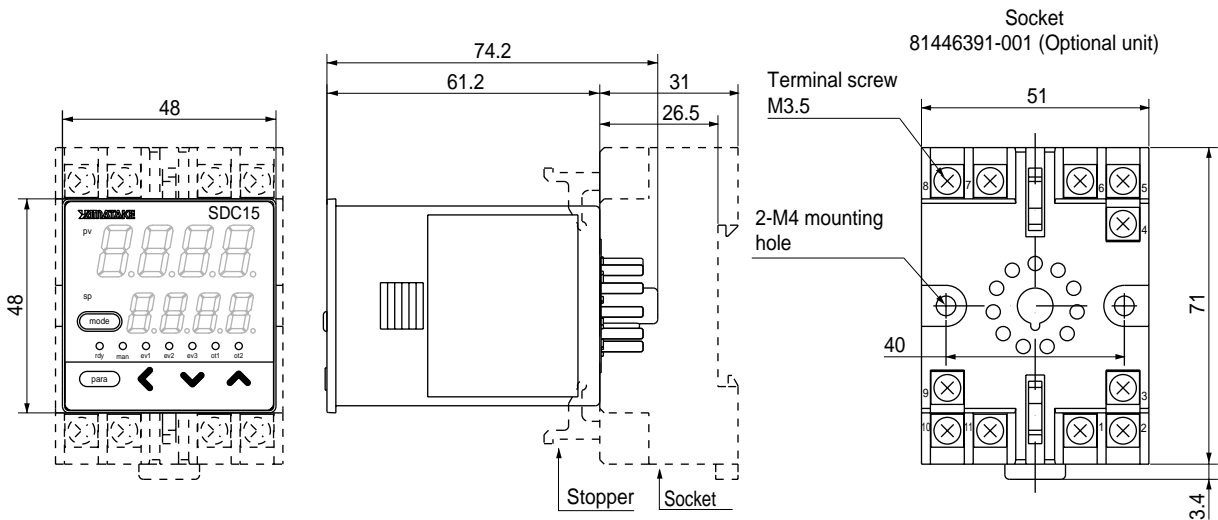

Panel Cutout Dimensions

For panel mounting type, make the mounting holes according to the panel hole making dimensions.

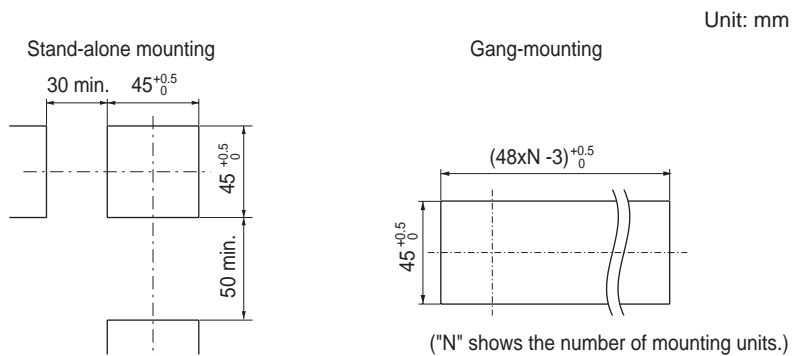

⚠ Handling Precautions

- When three or more units are gang-mounted horizontally, the maximum allowable ambient temperature is 40°C.
- Provide a space of at least 50 mm or more above and below the controller.

■ Mounting procedures

- The mounting must be horizontal within 10 degrees tilted in back side lowering or within 10 degrees tilted in back side rising.
- In the case of panel mount type (C15T), the mounting panel should be used with a thickness of more than 2 mm of steel.

● C15T (Panel mount type)

Items to be prepared:

Phillips-head screwdriver

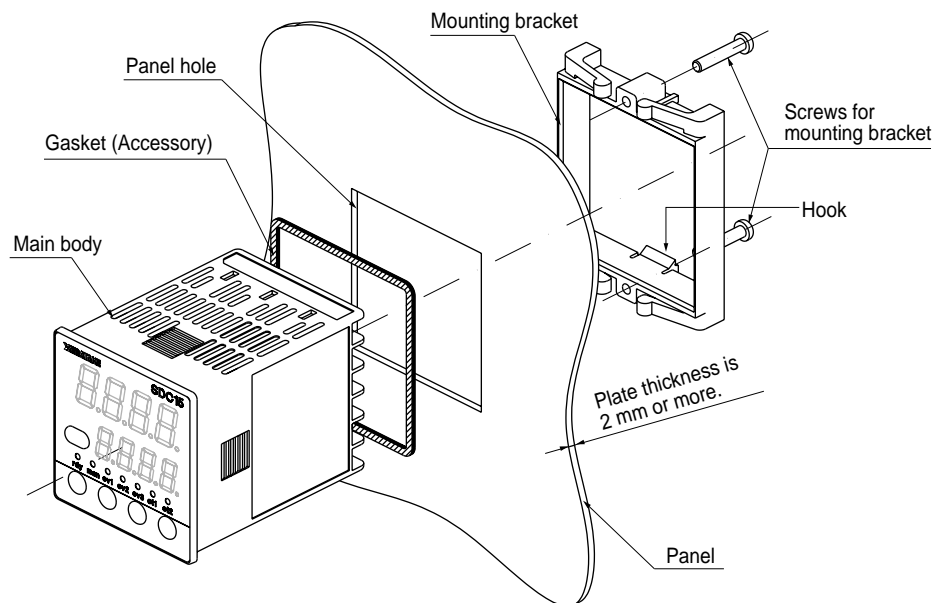

The above Figure shows the waterproof mounting using the gasket.
The gasket is not used for normal panel mounting.

- (1) Insert this unit from the front of the panel.
- (2) Fit the mounting bracket from the back of the panel.
- (3) Push the mounting bracket against the panel until the hook of the mounting bracket is firmly engaged with the groove of the main body.
- (4) Tighten the upper and lower screws of the mounting bracket.

For waterproof mounting:

The panel mounting type (C15T) can be waterproof-mounted.

To do so, attach the accessory gasket to the main body before above step (1).

After that, mount the main body with the gasket attached from above operation step (1) in order.

⚠ Handling Precautions

To fasten this controller onto the panel, tighten a mounting bracket screws, and turn one more half turn when there is no play between the bracket and panel. Excessively tightening the screws may deform the controller case.

● **C15T (Using the hard cover for panel mount type)**

For panel mounting type, it is possible to attach the hard cover to the front console. Use of hard cover makes it possible to prevent the settings from being changed due to accidental operation or to operate the unit in poor installation environment. The display can be seen with the cover kept closed. When operating the key, raise the cover and operate the key.

Items to be prepared:

Hard cover Part No. 81446442-001 (Optional unit)

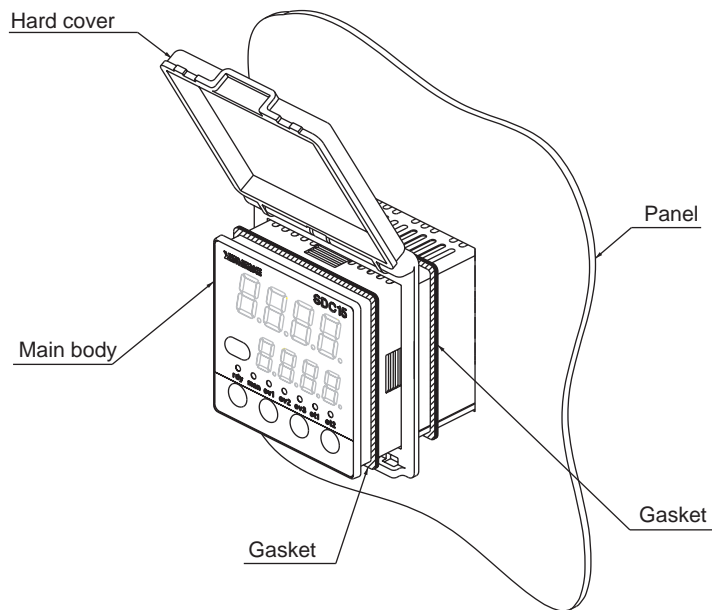

Both gaskets must be used, one is supplied with the main body and the other is supplied with the hard cover. Both are the same gaskets.

- (1) As shown in the Figure, mount the gasket, hard cover, and gasket on the main body in that order so that the hard cover is sandwiched by two gaskets.
- (2) Insert this unit from the front of the panel.
- (3) Fit the mounting bracket from the back of the panel.
- (4) Push the mounting bracket against the panel until the hook of the mounting bracket is firmly engaged with the groove of the main body.
- (5) Tighten the upper and lower screws of the mounting bracket.

! Handling Precautions

- To fasten this controller onto the panel, tighten a mounting bracket screws, and turn one more half turn when there is no play between the bracket and panel. Excessively tightening the screws may deform the controller case.
- It is possible to mount this unit without use of two gaskets if the waterproof feature is not needed and only the prevention of improper operation is aimed at.

● **C15T (Using the soft cover for panel mount type)**

For panel mounting type, it is possible to attach the soft cover to the front console. The key can be operated with the soft cover kept attached.

Additionally, when the soft cover is attached to the front console, this provides the feature similar to the waterproof mounting using the gasket.

Items to be prepared:

Soft cover Part No. 81446443-001 (Optional unit)

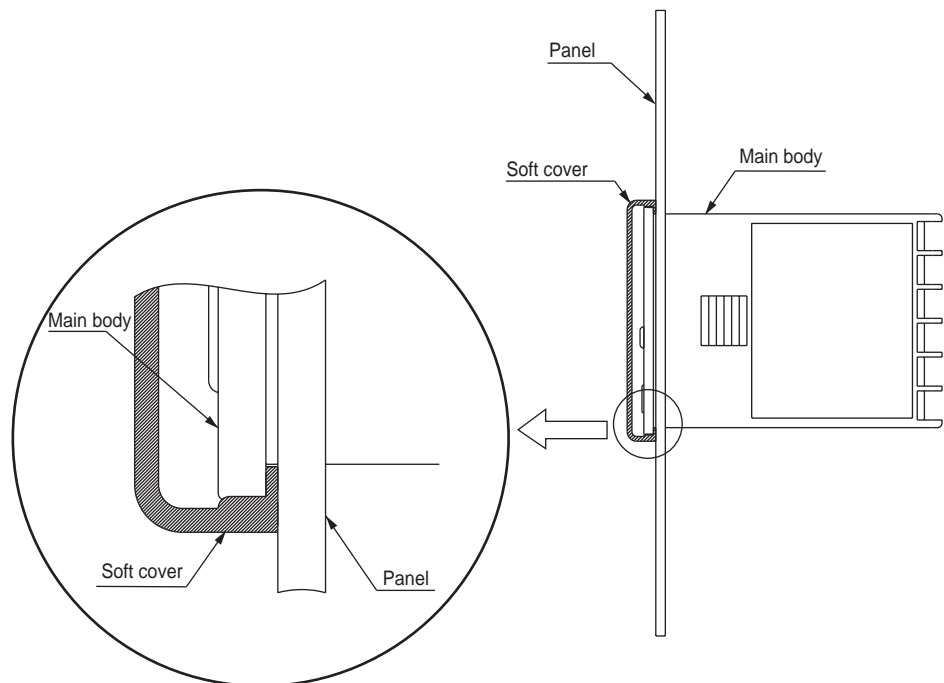

The gasket supplied with the main body is not used.

- (1) Attach the soft cover so that it covers the console of the main body.
- (2) Insert the unit with the soft cover attached from the front of the panel.
- (3) Fit the mounting bracket from the back of the panel.
- (4) Push the mounting bracket against the panel until the hook of the mounting bracket is firmly engaged with the groove of the main body.
- (5) Tighten the upper and lower screws of the mounting bracket.

⚠ Handling Precautions

To fasten this controller onto the panel, tighten a mounting bracket screws, and turn one more half turn when there is no play between the bracket and panel. Excessively tightening the screws may deform the controller case.

● C15S (Socket mount type)

Items to be prepared:

Phillips-head screwdriver

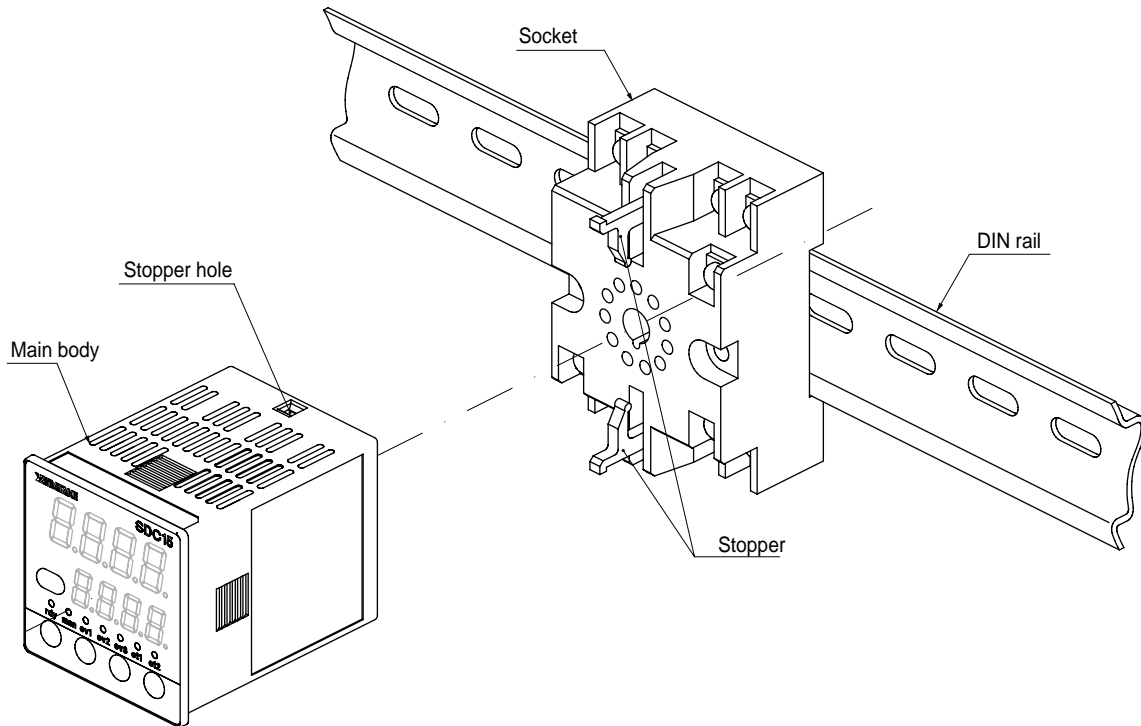

The above Figure shows the DIN rail mounting.

- (1) Mount the socket inside the panel. (For screw tightening, mount the socket directly.)
- (2) Perform the wiring to the socket.
- (3) Push this unit into the socket.
- (4) Put the upper and lower socket stoppers in the stopper holes in the main body, and then insert them.

! Handling Precautions

For socket mount type, it is necessary that the wiring must be completed before mounting this unit on the socket.

Chapter 4. WIRING

WARNING



Before wiring, or removing/mounting the SDC15, be sure to turn the power OFF.
Failure to do so might cause electric shock.



Do not touch electrically charged parts such as the power terminals.
Doing so might cause electric shock.

CAUTION



Wire the SDC15 properly according to predetermined standards.
Also wire the SDC15 using specified power leads according to recognized installation methods.
Failure to do so might cause electric shock, fire or faulty operation.



Do not allow lead clippings, chips or water to enter the controller case.
Doing so might cause fire or faulty operation.



Firmly tighten the terminal screws at the torque listed in the specifications.
Insufficient tightening of terminal screws might cause electric shock or fire.



Do not use unused terminals on the SDC15 as relay terminals.
Doing so might cause electric shock, fire, or faulty operation.



We recommend attaching the terminal cover (sold separately) after wiring the SDC15.
Failure to do so might cause electric shock, fire, or faulty operation.



Use the relays within the recommended life.
Failure to do so might cause fire or faulty operation.



Use Yamatake Corporation's "SURGENON" if there is the risk of power surges caused by lightning.
Doing so might cause fire or faulty operation.



Do not make incorrect connections. If the cables are connected incorrectly, this might cause the unit to malfunction.



The controller does not function for approximately 6 sec. after the power has been turned ON. Great care should be taken when the relay output from the controller is used as interlock signals.



The part between the control output 1 and control output 2 is not isolated.
When necessary, use an appropriate isolator.



Do not connect multiple loader cables to multiple units from one personal computer. The current coming from other circuits might cause the PV value indication error to occur.



Do not connect any terminating resistor to both ends of the communication path when performing the RS-485 wiring. Doing so might cause the communication to fail.



Always mount a switch for shut-down of the main power of this unit in an easily accessible area of the operator when performing electric wiring of this unit. Additionally, connect a slow-action type (T) fuse having a rated current of 0.2A and rated voltage of 250V to the wiring for the instrument power supply of the AC power supply model. (IEC127)

■ Terminal assignment label symbols

The following table shows the meanings of the symbols used for the terminal assignment label attached to the side panel of this unit:

Symbol	Contents
⋯	DC
~	AC
⚠	Caution, Electric shock hazard
⚠	Caution

■ Wiring Precautions

- Before starting the wiring work, carefully check the label on the side panel of this unit to understand the model No. and terminal No. to carry out the wiring properly.
- For panel mount type, use an appropriate crimp type terminal lug suitable for the M3 screw to connect the terminals. The tightening torque of the terminal screw must be 0.4 to 0.6N·m.
- For socket mount type, use an appropriate crimp type terminal lug suitable for the M3.5 screw to connect the terminals. The tightening torque of the terminal screw must be 0.78 to 0.98 N·m or less.
- Pay special attention so that no crimp terminals are in contact with adjacent terminals.
- Keep the input/output signal cables 50cm or more away from the drive power cable and/or power cable. Additionally, do not pass the input/output signal cables and the drive power cable and/or power cable together through the same conduit or duct.
- When connecting this unit and other measuring instrument in parallel, carefully check the conditions necessary for other instrument before starting the instrumentation.
- The digital input is so designed that it is non-voltage input. A contact for micro current must be used.
- Pass the conductor, to which the heater current flows, through the current transformer. Additionally, carefully check that the heater current does not exceed the allowable current level stated in the specification. If the heater current exceeds the allowable current level, this might cause damage to this unit.
- The input of the current transformer cannot be used for the phase angle control.
- For panel mounting type (C15T), an optional terminal cover is available to prevent electric shock. (Model No.: 81446898-001)

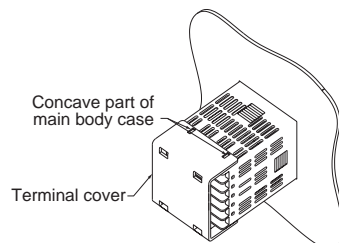

- The part between the control output 1 and control output 2 is not isolated. When necessary, use an appropriate isolator.
- Do not connect any terminating resistor to both ends of the RS-485 communication path. Doing so might cause the communication to fail.
- Devices and systems to be connected to this unit must have the basic insulation suitable for the maximum operating voltage levels of the power supply and input/output part.

- This unit is so designed that it does not start functioning for up to 6 sec. after the power has been turned ON in order to ensure stable operation. After that, the unit then enters the operation mode. However, to satisfy the specified accuracy, it is necessary to warm up the unit for at least 30 min.

● Wiring of C15T

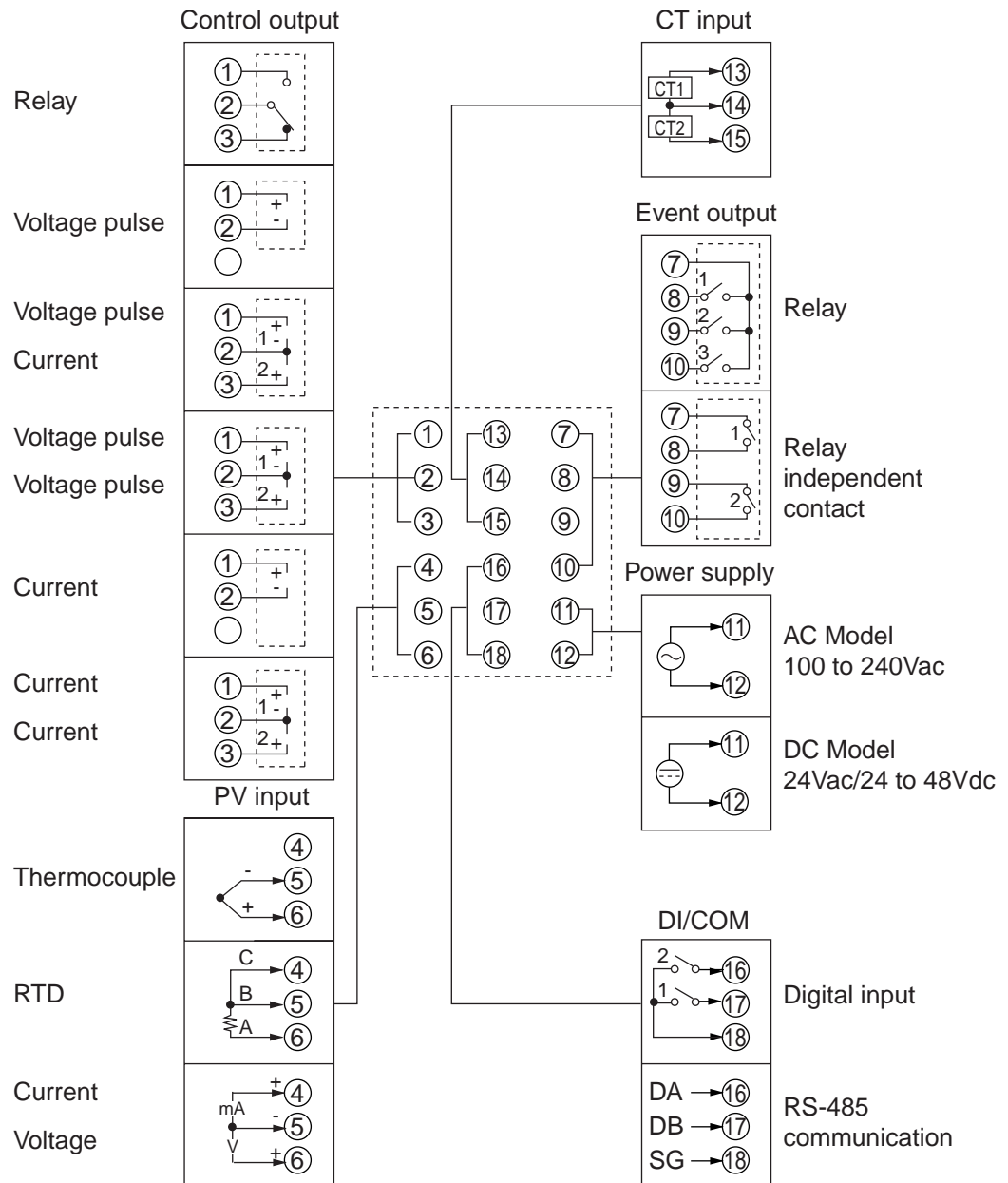

● Wiring of C15S

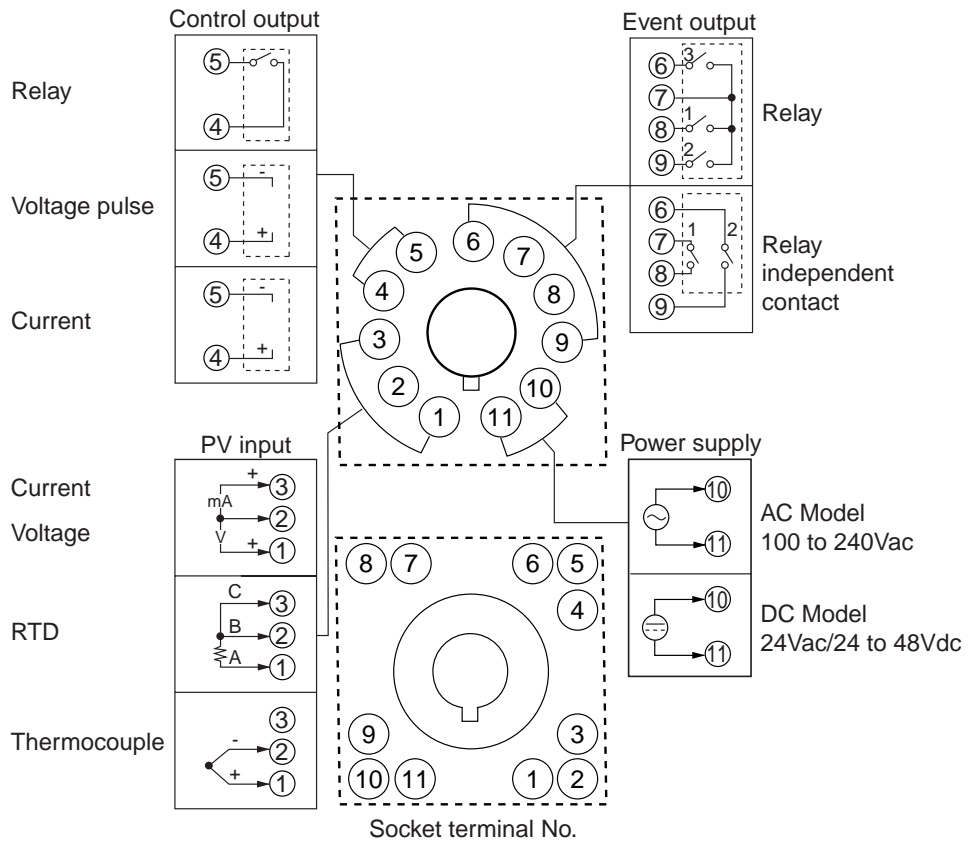

● Recommended crimp type terminal lugs

For C15T, use an appropriate crimp type terminal lug suitable for the M3 screw.
 For C15S socket mounting type, use an appropriate crimp type terminal lug suitable for the M3.5 screw.

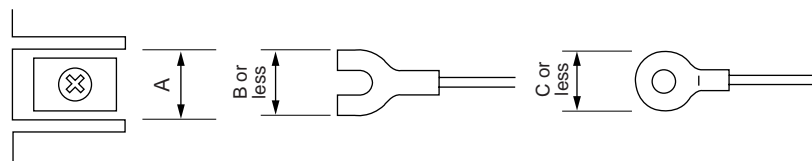

Mounting method	Applicable screw	Terminal dimensions (mm)			Recommended crimp terminal JIS indication	Applicable electric wire size	J.S.T. Mfg. Co., Ltd Model No. (Reference)
		A	B	C			
C15T panel mounting type	M3	6.1	5.8	5.8	RAV1.25 - 3	0.25 to 1.65mm ² AWG22 to 16	V1.25 - 3 V1.25 B3A
C15S socket mounting type	M3.5	7.4	6.4	6.6	RAV1.25 - 3.5	0.25 to 1.65mm ² AWG22 to 16	V1.25 - M3 V1.25 YS3A

! Handling Precautions

- When installing this unit in a place where the vibration or impact is large, always use an appropriate round crimp terminal so that it is not disengaged from the connection terminal.
- Pay special attention so that no crimp terminals are in contact with adjacent terminals.

■ Connection of open collector output to digital input

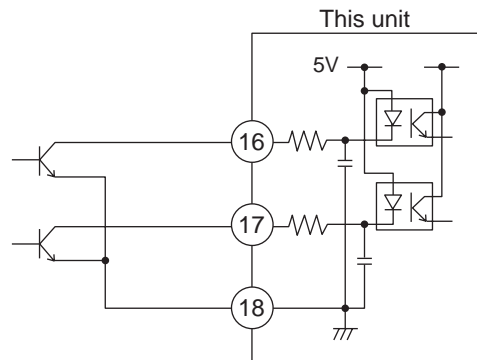

■ Connection of communication (RS-485) cable

● 3-wire system

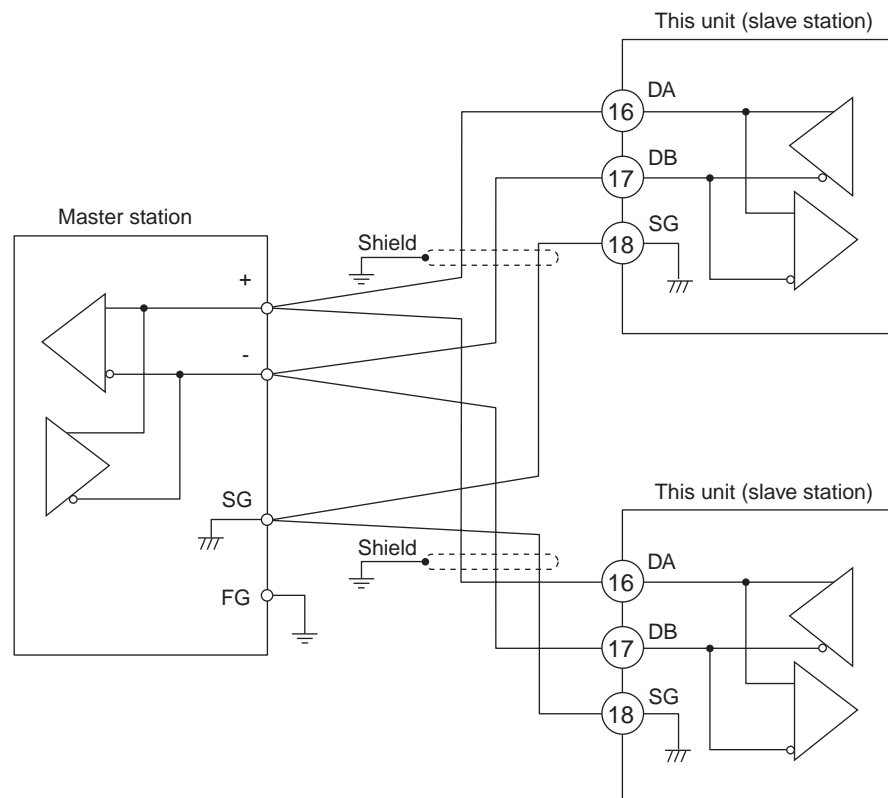

! Handling Precautions

- Do not connect DA and DB. Doing so might cause damage to this unit.
- Ground the shield line to one point on one side of the cable.
- Do not connect any terminating resistor to both ends of the communication path. Doing so might cause the communication to fail.
- Even though any units requiring the terminating resistor exist in the communication path, do not connect any terminating resistor.
- Be sure to connect SG terminals each other.
Failure to do so might cause unstable communications.

● 5-wire system

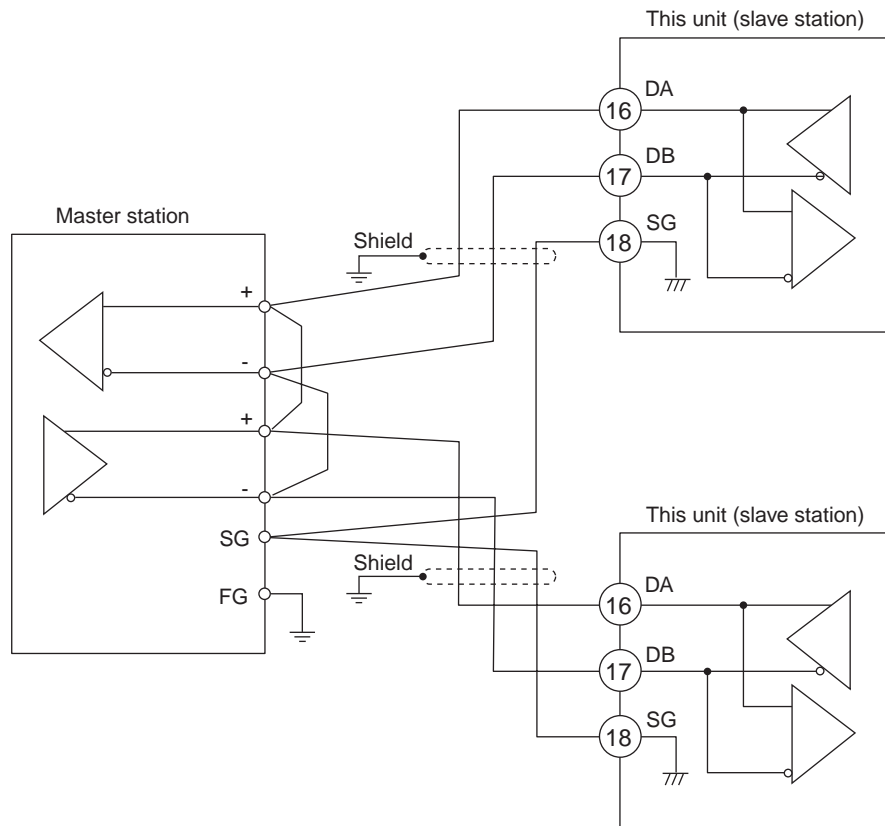

⚠ Handling Precautions

- Do not connect DA and DB. Doing so might cause damage to this unit.
- Ground the shield line to one point on one side of the cable.
- Do not connect any terminating resistor to both ends of the communication path. Doing so might cause the communication to fail.
- Even though any units requiring the terminating resistor exist in the communication path, do not connect any terminating resistor.
- Be sure to connect SG terminals each other. Failure to do so might cause unstable communications.

■ Connection with SSR (solid state relay)

To drive the SSR, a model having voltage pulse outputs (V0, VC, or VV) must be used.

Generally, the SSR is classified into two groups, constant current type and resistor type. The following describes how to connect each type:

● Constant current type (Omron's G3PA, G3PB, G3NA, etc.)

The following specifications of the SSR you are using and the specifications of the voltage pulse output must be investigated:

- Input current (maximum): When the input current is the maximum allowable current or less, the parallel connection can be made.
- Operating voltage range (input): Check that the voltage between the terminals of the voltage pulse output is within the specified range.

(Example) Omron G3PA

- Input current: Since the input current is 7mA or less, up to three units ($7\text{mA} \times 3 = 21\text{mA} < 24\text{mA}$ [maximum allowable current]) can be connected in parallel.
- Operating voltage range (input): The rating voltage is 5 to 24Vdc or 12 to 24Vdc. Therefore, the voltage between the terminals is within the range.

Voltage between terminals (three G3PA units)

$$\begin{aligned} &= \text{Open voltage} - \text{internal resistance} \times \text{total drive current} \\ &= 19\text{Vdc} \pm 15\% - 82\Omega \pm 0.5\% \times 21\text{mA} \\ &\approx 14 \text{ to } 20\text{V} \end{aligned}$$

Connection diagram

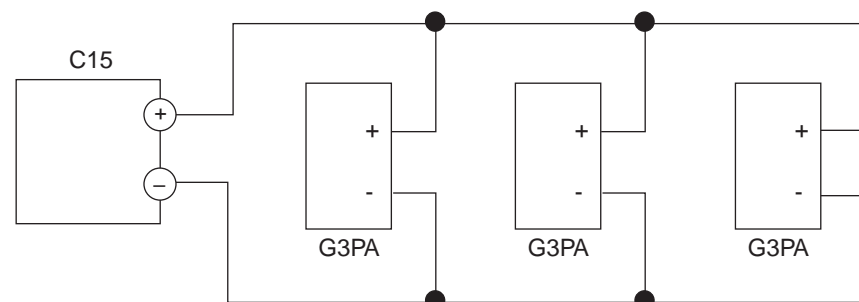

Number of connectable units

SSR to be used	Connection	V0 model	VV model
Omron G3PA	Parallel connection	Up to 3 units	Up to 6 units (Note)
Omron G3PB	Parallel connection	Up to 3 units	Up to 6 units (Note)
Omron G3NA	Parallel connection	Up to 3 units	Up to 6 units (Note)

(Note) 3 units for each output

● Resistor type (Yamatake's PGM, etc.)

When necessary, an appropriate external resistor is connected in series so that the voltage between the input terminals of the SSR you are using is within the specified range.

(Example) Connection of two Yamatake PGM units

Connection diagram

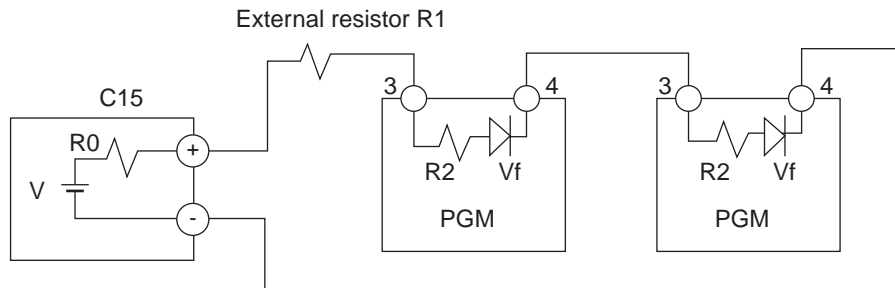

V: 19V ± 15%

R0: 82Ω ± 0.5%

R1: 680 Ω

R2: 260 Ω

Vf: 1.1V

$$\text{Voltage between terminals of PGM} = (V - 2 \times Vf) / (R0 + R1 + R2 + R2) \times R2 + Vf \approx 4.5 \text{ V}$$

Input voltage range of PGM: Since the input voltage range is 3 to 6V, the operation is possible.

External resistors

SSR to be used	Number of units to be connected	Connection	External resistor	Remarks
Yamatake PGM	1	–	1kΩ (serial connection)	Rating is 1/2W or more.
	2	Serial connection	680Ω (serial connection)	Rating is 1/2W or more.
	3	Serial connection	330Ω (serial connection)	Rating is 1/2W or more.
	4	Serial connection	None	

Number of connectable units

SSR to be used	Connection	V0 model	VV model
Yamatake PGM	Serial connection	Up to 4 units	Up to 8 units (Note)

(Note) 4 units for each output

■ Noise Preventive Measures

The power is taken from the single-phase instrumental power supply to consider noise preventive measures.

If the noise from the power supply is large, an appropriate insulation transformer is added to the power supply and an appropriate line filter is used.

(Yamatake's line filter model No.: 81446364-001)

If the noise has fast rising edge, an appropriate CR filter is used.

(Yamatake's CR filter model No.: 81446365-001)

Handling Precautions

After the noise preventive measures have been taken, do not bundle the primary and secondary sides of the insulation transformer together or put them in the same conduit or duct.

Chapter 5. DETAILED DESCRIPTION OF EACH FUNCTION

5 - 1 PV Input

The following shows the functional block diagram of the PV input:

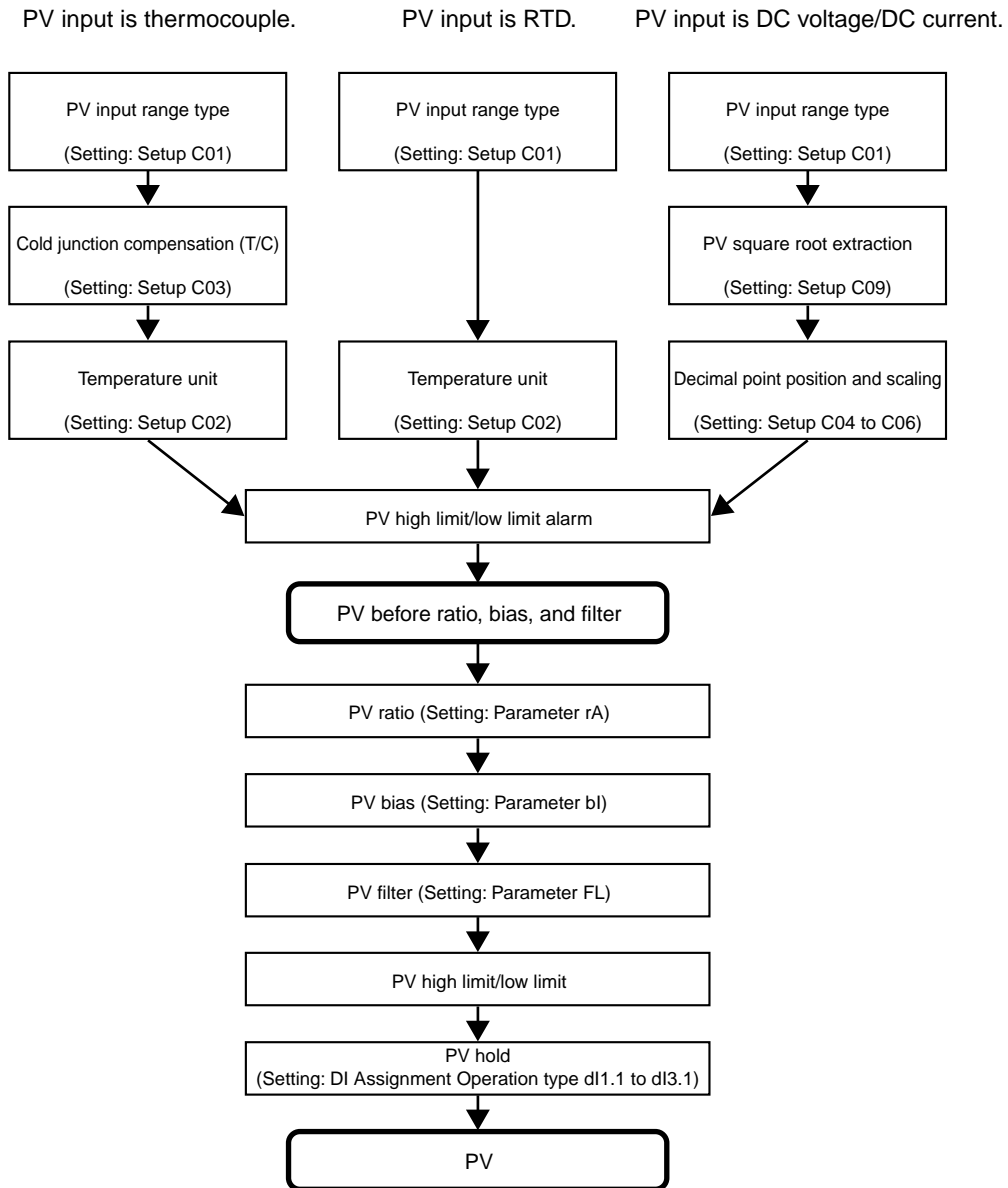

■ PV input range type

When the PV input type is T (thermocouple) or R (RTD), the sensor type and temperature range can be selected.

When the PV input range type is L (DC voltage/DC current), the signal type can be selected.

Item (Setting display/bank)	Display	Contents	Initial value	User level
PV input range type (Setup setting/Setup bank)		The contents may vary depending on the PV input range type. For details, refer to the PV input range table.	The initial value may vary depending on the PV input range type as shown below. "T": 1 "R": 41 "L": 88	Simple, Standard, High function

PV input range table

C01 No.	Sensor type	Range (Celsius)	Range (Fahrenheit)
1	K	-200 to +1200°C	-300 to +2200°F
2	K	0 to 1200°C	0 to 2200°F
3	K	0 to 800°C	0 to 1500°F
4	K	0 to 600°C	0 to 1100°F
5	K	0 to 400°C	0 to 700°F
6	K	-200 to +400°C	-300 to +700°F
9	J	0 to 800°C	0 to 1500°F
10	J	0 to 600°C	0 to 1100°F
11	J	-200 to +400°C	-300 to +700°F
13	E	0 to 600°C	0 to 1100°F
14	T	-200 to +400°C	-300 to +700°F
15	R	0 to 1600°C	0 to 3000°F
16	S	0 to 1600°C	0 to 3000°F
17	B	0 to 1800°C	0 to 3300°F
18	N	0 to 1300°C	0 to 2300°F
19	PL II	0 to 1300°C	0 to 2300°F
20	WRe5-26	0 to 1400°C	0 to 2400°F
21	WRe5-26	0 to 2300°C	0 to 4200°F
24	DIN U	-200 to +400°C	-300 to +700°F
25	DIN L	-100 to +800°C	-150 to +1500°F

C01 No.	Sensor type	Range (Celsius)	Range (Fahrenheit)
41	Pt100	-200 to +500°C	-300 to +900°F
42	JPt100	-200 to +500°C	-300 to +900°F
43	Pt100	-200 to +200°C	-300 to +400°F
44	JPt100	-200 to +200°C	-300 to +400°F
45	Pt100	-100 to +300°C	-150 to +500°F
46	JPt100	-100 to +300°C	-150 to +500°F
51	Pt100	-50.0 to +200.0°C	-50 to +400°F
52	JPt100	-50.0 to +200.0°C	-50 to +400°F
53	Pt100	-50.0 to +100.0°C	-50 to +200°F
54	JPt100	-50.0 to +100.0°C	-50 to +200°F
63	Pt100	0.0 to 200.0°C	0 to 400°F
64	JPt100	0.0 to 200.0°C	0 to 400°F
67	Pt100	0 to 500°C	0 to 900°F
68	JPt100	0 to 500°C	0 to 900°F

C01 No.	Sensor type	Range
84	0 to 1V	The scaling is made in a range of -1999 to +9999.
85	1 to 5V	
87	0 to 5V	
88	0 to 10V	The decimal point position can be changed variably.
89	0 to 20mA	
90	4 to 20mA	

! Handling Precautions

- The accuracy of the B thermocouple is ±5%FS at 260°C or less and ±1%FS at 260 to 800°C.
- The accuracy of the PLII thermocouple(C01 No.19) in the range of 0 to 32°F does not meet the indication accuracy specified in the chapter 11 SPECIFICATIONS.
- When an input range has the decimal point display, the PV and/or SP can be displayed on the console of this unit so that they are displayed to the 1st digit after the decimal point or without the decimal point.
- PL II thermocouple is a range, which has been added to the units manufactured from July, 2003.

■ Temperature unit

When the PV input type is T (thermocouple) or R (RTD), the temperature unit can be selected.

Item (Setting display/bank)	Display	Contents	Initial value	User level
Temperature unit (Setup setting/Setup bank)		0: Celsius (°C) 1: Fahrenheit (°F).	0	Simple, Standard, High function

- When the PV input type is T (thermocouple) or R (RTD), the display and setting can be made.

■ Cold junction compensation (T/C)

When the PV input type is T (thermocouple), any of the following can be selected:

- The cold junction compensation (T/C) is performed inside this unit.
- The cold junction compensation (T/C) is not performed inside this unit since an external cold junction compensation unit, such as ice bath is used.
- When the PV input type is T (thermocouple), the display and setting can be made.

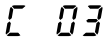
Item (Setting display/bank)	Display	Contents	Initial value	User level
Cold junction compensation (T/C) (Setup setting/Setup bank)		0: Cold junction compensation (T/C) is performed (internal). 1: Cold junction compensation (T/C) is not performed (external).	0	High function

■ PV square root extraction dropout

When the PV input type is L (DC voltage/DC current), a dropout value can be set so that the result of the PV square root extraction used to convert the pressure (differential pressure) into the flow becomes "0".

- When the PV input type is L (DC voltage/DC current), the display and setting can be made.

Item (Setting display/bank)	Display	Contents	Initial value	User level
PV square root extraction dropout (Setup setting/Setup bank)		0.0%: Square root extraction is not performed. 0.1 to 100.0%	0.0%	High function

- Details of PV square root extraction

The calculation input in % and the calculation result in % are expressed as PV_{in} and PV_{out}, respectively.

When the PV input is the PV square root extraction dropout set value or more and less than 100.0%, the control formula becomes as shown below.

$$PV_{out} = \sqrt{PV_{in} \div 100} \times 100$$

When the PV input is larger than 0.0% and smaller than the PV square root extraction dropout set value, PV_{out} = 0.0%.

When the PV input is 0.0% or less or 100.0% or more, the square root extraction is not performed. Therefore, PV_{out} = PV_{in}.

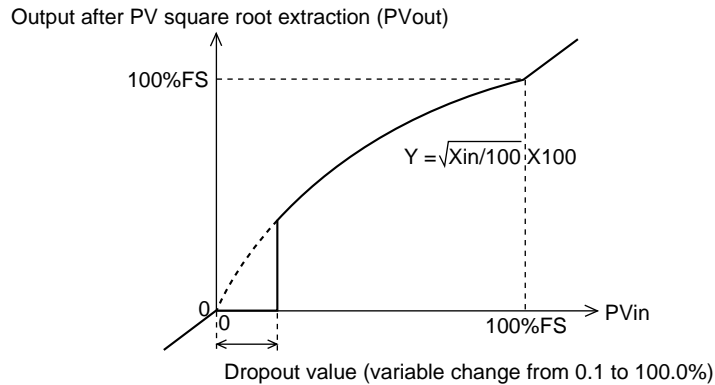

■ Decimal point position

When the PV input type is L (DC voltage/DC current) or when the PV input type is a part of the PV input range type of R (RTD), the decimal point position of the PV input can be set.

Item (Setting display/bank)	Display	Contents	Initial value	User level
Decimal point position (Setup setting/Setup bank)		0: No decimal point 1: 1 digit after decimal point 2: 2 digits after decimal point 3: 3 digits after decimal point	0	Simple, Standard, High function

- When the PV input type is L (DC voltage/DC current), the display and setting can be made.
- When the PV input type is R (RTD) and the PV input range type is a range having the decimal point stated in PV range table (on page 5-2) of 5-1 PV Input, "0: No decimal point" or "1: 1 digit after decimal point" can be displayed and set.

Handling Precautions

As this setting is changed, the decimal point position of the parameters related to the decimal point position of the PV input is also changed. Actually, the decimal point position of the following settings are changed:

- SP setting
- SP low limit/high limit setting
- SP up ramp/down ramp setting
- Event setting and continuous output setting related to PV
- Event setting and continuous output setting related to SP
- Event setting and continuous output setting related to deviation (absolute deviation)

■ PV input range low limit/high limit

When the PV input type is L (DC voltage/DC current), the scaling of the PV input can be set.

Item (Setting display/bank)	Display	Contents	Initial value	User level
PV input range low limit (Setup setting/Setup bank)	<i>C 05</i>	When the PV input type is "L", the following contents apply: -1999 to +9999 (no decimal point) -199.9 to +999.9 (1 digit after decimal point) -19.99 to +99.99 (2 digits after decimal point) -1.999 to +9.999 (3 digits after decimal point) When the PV input type is "T" or "R", the range low limit and high limit values selected using the PV input range type are used.	When the PV input type is "L", the initial value is "0".	Simple, Standard, High function
PV input range high limit (Setup setting/Setup bank)	<i>C 06</i>		When the PV input type is "L", the initial value is "1000".	

- When the PV input type is T (thermocouple) or R (RTD), the setting item can be displayed, but the setting cannot be made.
- When the PV input type is L (DC voltage/DC current), the display and setting can be made.

The following describes the relationship between the PV input and PV when setting up the range low limit and high limit.

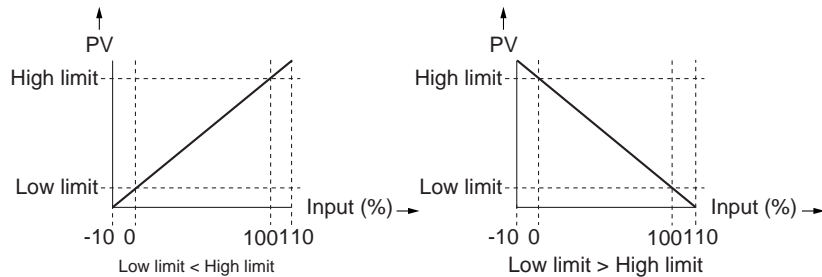

■ PV ratio and PV bias

The PV ratio and PV bias can be set to compensate the PV.

Item (Setting display/bank)	Display	Contents	Initial value	User level
PV ratio (Parameter setting/Parameter bank)	<i>r R</i>	0.001 to 9.999	1.000	Standard, High function
PV bias (Parameter setting/Parameter bank)	<i>b i</i>	-1999 to +9999 U	0U	Simple, Standard, High function

- Details of PV ratio and PV bias controls

Assuming that the control input is PV_{in}, control result is PV_{out}, PV ratio is RA, and PV bias is BI, the following control formula is obtained:

$$PV_{out} = (PV_{in} \times RA) + BI$$

■ **PV filter**

This PV filter is a primary delay filter to be used if the PV repeatedly fluctuates rapidly and the control cannot be performed or if the PV fluctuates finely due to influence of noise, etc.

As a larger value is set, it becomes difficult to change the PV used for the control of this unit.

Normally, the PV filter is used with an initial value of "0.0".

Item (Setting display/bank)	Display	Contents	Initial value	User level
PV filter (Parameter setting/Parameter bank)	<i>FL</i>	0.0: No filter 0.1 to 120.0s	0.0s	Simple, Standard, High function

$$OUT = OUT_{-1} + (IN - OUT_{-1}) / (T / Ts + 1)$$

IN: Input to PV filter

OUT: Control output of current filter

OUT₋₁: Control output of previous filter

T: Filter set value (s)

Ts: Sampling cycle time (0.5s)

■ **PV hold**

It is possible to set the PV to a fixed value using the PV hold, PV Max. hold, and PV Min. hold of the DI (digital input) functions.

PV hold: PV is set to a fixed value and it is not updated.

PV Max. hold: PV maximum value is held.

The PV value is updated only when the new PV value is larger than the currently held value.

PV Min. hold: PV minimum value is held.

The PV value is updated only when the new PV value is smaller than the currently held value.

■ **PV low limit/high limit and PV low limit/high limit alarms**

PV low limit and PV high limit are provided for each PV input range type.

In principle, -10%FS of each range becomes the PV low limit while +110%FS becomes the PV high limit.

For details,

 refer to page 10-2.

The PV is limited so that it is within a range between the PV low limit and PV high limit.

If the PV before activation of the PV ratio, PV bias, and PV filter is larger than the PV high limit, PV high limit alarm (AL01) occurs. On the contrary, if this PV is smaller than the PV low limit, the PV low limit alarm (AL02) occurs.

5 - 2 Mode

It is possible to set the AUTO/MANUAL mode selection, RUN/READY mode selection, AT (Auto Tuning) stop/start selection, release all DO (digital output) latches, and OFF/ON selection of communication DI (digital input) 1.

■ AUTO/MANUAL mode

The AUTO/MANUAL mode selection can be set.

Item (Setting display/bank)	Display	Contents	Initial value	User level
AUTO/MANUAL (Parameter setting/Mode bank)	A--M	AUto: AUTO mode [Communication value is "0".] MAn: MANUAL mode [Communication value is "1".]	Auto	Simple, Standard, High function

- When the AUTO/MANUAL mode is changed, the display is automatically returned to the operation display.
- If the operation type of internal contacts 1 to 3 is set at "AUTO/MANUAL", [A--M: AUTO/MANUAL] can be displayed, but the setting cannot be made.
- When [Ctrl: Control method] is set at "0" (ON/OFF control), [A--M: AUTO/MANUAL] cannot be displayed and set.
- When [bit 0: AUTO/MANUAL display] of [C73: MODE display setup] is set at "0" (no display), [A--M: AUTO/MANUAL] cannot be displayed and set.

■ RUN/READY mode

The RUN/READY mode selection can be set.

Item (Setting display/bank)	Display	Contents	Initial value	User level
RUN/READY (Parameter setting/Mode bank)	r--r	rUn: RUN mode [Communication value is "0".] rdy: READY mode [Communication value is "1".]	rUn	Simple, Standard, High function

- If the operation type of internal contacts 1 to 3 is set at "RUN/READY", [r--r: RUN/READY] can be displayed, but the setting cannot be made.
- When [bit 1: RUN/READY display] of [C73: MODE display setup] is set at "0" (no display), [r--r: RUN/READY] cannot be displayed and set.

■ AT (Auto Tuning) stop/start

The AT stop/start selection can be set.

Item (Setting display/bank)	Display	Contents	Initial value	User level
AT (Auto Tuning) stop/start (Parameter setting/Mode bank)	<i>At</i>	At.oF: AT stop [Communication value is "0".] At.ON: AT start [Communication value is "1".]	At.oF	Simple, Standard, High function

- The AT is stopped in the MANUAL or READY mode.
- If the PV high limit alarm (AL01) or PV low limit alarm (AL02) occurs, the AT is stopped.
- If the operation type of internal contacts 1 to 3 is set at "AT stop/start", [At: AT stop/start] can be displayed, but the setting cannot be made.
- When [Ctrl: Control method] is set at "0" (ON/OFF control), [At: AT stop/start] cannot be displayed and set.
- When [bit 3: AT stop/start display] of [C73: MODE display setup] is set at "0" (no display), [At: AT stop/start] cannot be displayed and set.

For details about AT,

 refer to AT (on page 5-18) and AT function (on page 5-21).

■ Release all DO (digital output) latches

Release all DO (digital output) latches can be set.

Item (Setting display/bank)	Display	Contents	Initial value	User level
Release all DO (digital output) latches (Parameter setting/Mode bank)	<i>doLt</i>	Lt.ON: Latch is continued. [Communication value is "0".] Lt.oF: Latch is released. [Communication value is "1".]	Lt.ON	Simple, Standard, High function

- If the operation type of internal contacts 1 to 3 is set at "Release all DO latches", [do.Lt: Release all DO latches] can be displayed, but the setting cannot be made.
- When [bit 4: Release all DO latches display] of [C73: MODE display setup] is set at "0" (no display), [do.Lt: Release all DO latches] cannot be displayed and set.

■ Communication DI (digital input) 1

Communication DI (digital input) 1 can be set.

Item (Setting display/bank)	Display	Contents	Initial value	User level
Communication DI (digital input) 1 (Parameter setting/Mode bank)	<i>C.DI 1</i>	DI.oF: Communication DI1. OFF [Communication value is "0".] DI.ON: Communication DI1. ON [Communication value is "1".]	DI.oF	Simple, Standard, High function

- Four communication DIs, DI1 to DI4, are provided. However, only communication DI 1 can be set using the key operation.
- The function (operation) with communication DI 1 can be set using the DI Assignment.
- When [bit 5: Communication DI 1 display] of [C73: MODE display setup] is set at "0" (no display), [C.DI1: Communication DI 1] cannot be displayed and set.

5 - 3 Control

The following shows the functional block diagram of the control (ON/OFF control, PID control, RationalLOOP control, and Heat/Cool control, etc.):

ON/OFF control

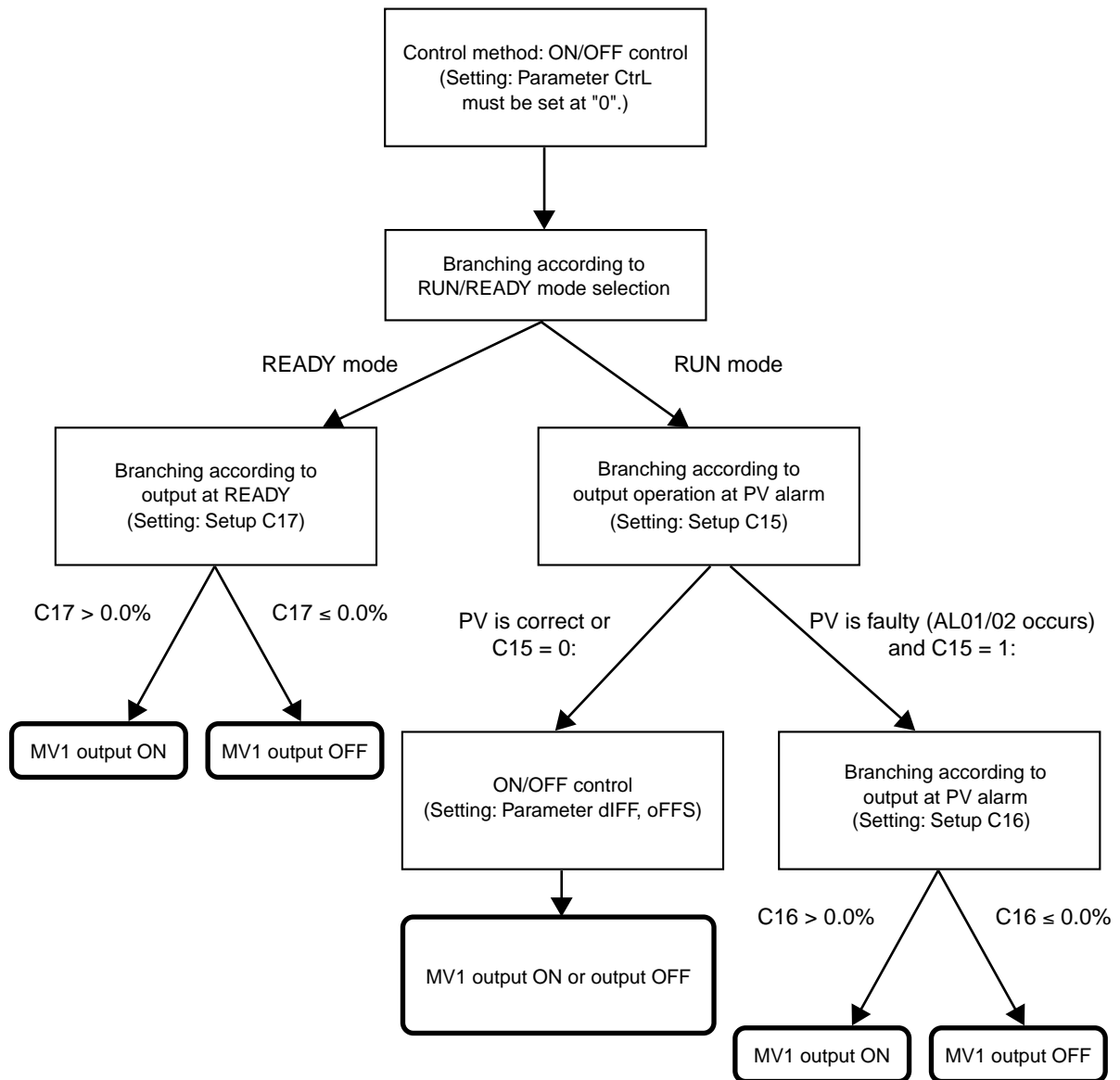

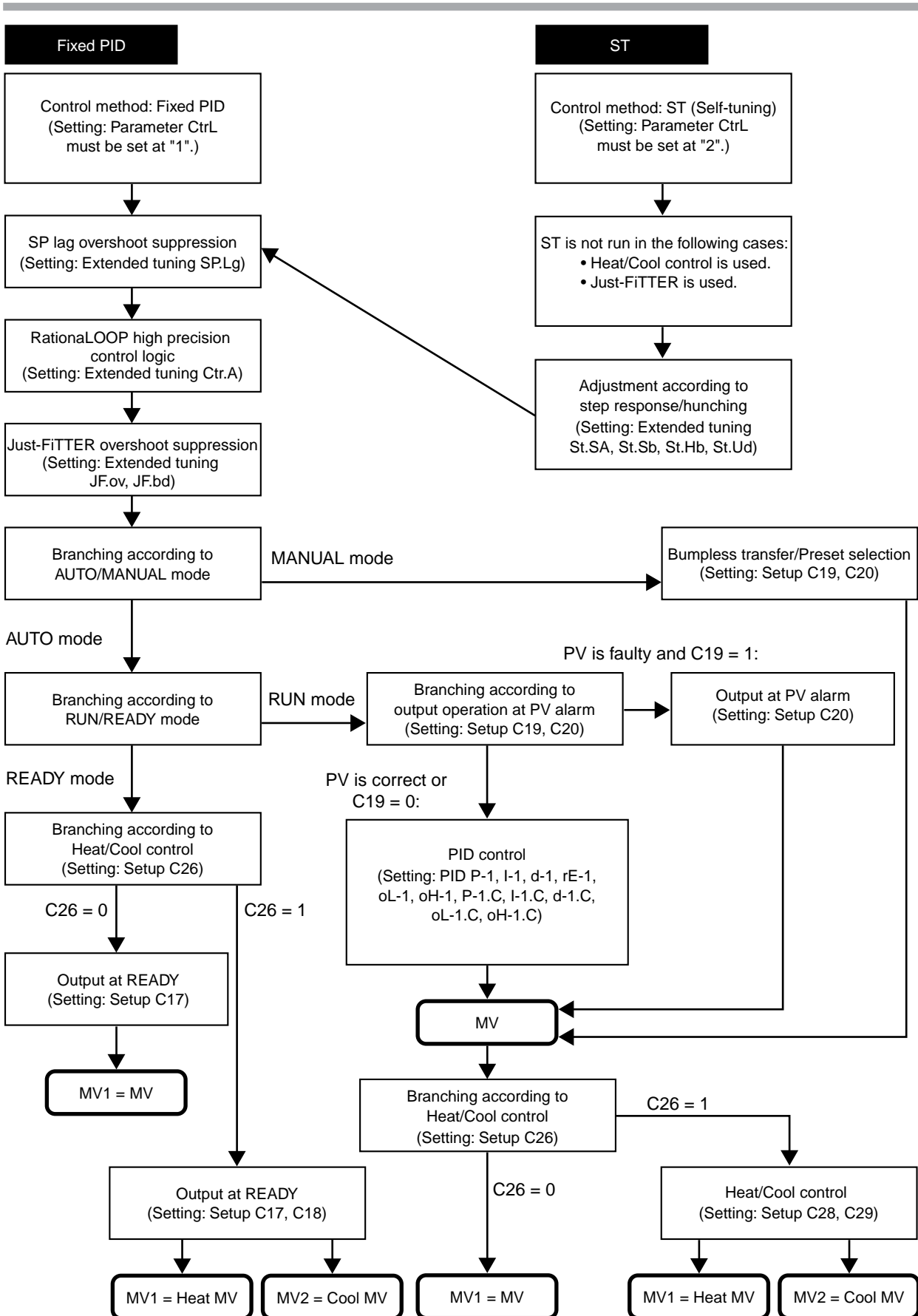

■ Control method

A desired control method can be selected from three kinds of control methods.

Item (Setting display/bank)	Display	Contents	Initial value	User level
Control method (Parameter setting/Parameter bank)		0: ON/OFF control 1: Fixed PID 2: ST (Self-tuning)	0 or 1	Simple, Standard, High function

- When the control output type is relay (R0), the initial value becomes "0". The initial value is "1" in other cases.
- "Fixed" of [1: Fixed PID] means that the PID constant is not changed automatically since the ST is not run. However, the AT can be run even in the fixed PID control.
- When using the Heat/Cool control (C26=1) or when using the Just-FiTTER control (JF.ov > 0), the ST is not run even though [2: ST] is set.
- The following Table shows valid and invalid functions related to [1: Fixed PID] and [2: ST], as well as other related parameters:

Classification of Heat/Cool control	Classification of RationalLOOP	Classification of control action	RationalLOOP function	AT	ST	Just-FiTTER
Normal control	Normal PID	P control	X	○ *	X	X
		PI control	X	○ *	X	○
		PD control	X	○ *	X	X
		PID control	X	○	○	○
	RationalLOOP	P control	X	○ *	X	X
		PI control	X	○ *	X	○
		PD control	X	○ *	X	X
		PID control	○	○	○	○
Heat/Cool control	Normal PID	P control	X	○ *	X	X
		PI control	X	○ *	X	○
		PD control	X	○ *	X	X
		PID control	X	○	X	○
	RationalLOOP	P control	X	○ *	X	X
		PI control	X	○ *	X	○
		PD control	X	○ *	X	X
		PID control	○	○	X	○
Remarks				*Adjustment result becomes the PID control.		
Related settings			Control algorithm	AT type	ST step execution resolution width	Just-FiTTER overshoot limit/restraint/control coefficient
				MV low limit at AT	ST step settling width	Just-FiTTER settling band
				MV high limit at AT	ST hunching settling width	
				AT Proportional band adjust	ST step ramp change	
				AT Integral time adjust		
				AT Derivative time adjust		

■ Control action and Heat/Cool control

The control action (direct/reverse) and Heat/Cool control (enabled/disabled) can be selected.

Item (Setting display/bank)	Display	Contents	Initial value	User level
Control action (direct/reverse) (Setup setting/Setup bank)	C 14	0: Heat control (Reverse) 1: Cool control (Direct)	0	Simple, Standard, High function
Heat/Cool control (Setup setting/Setup bank)	C 26	0: Disabled. 1: Enabled.	0	Simple, Standard, High function

- When the control method is other than the ON/OFF control (Ctrl ≠ 0), [Heat/Cool control: C26] can be displayed and set.
- When the Heat/Cool control is set disabled (C26 = 0), [Control action: C14] can be displayed and set.
- When the Heat/Cool control is set enabled (C26 = 1), the control action is changed to the reverse action (C14 = 0), the preset MANUAL value (C20) is changed to "50.0", and the initial output of PID control (C22) is changed to "50.0".
- The reverse action (heat control) is a control that decreases (or turns OFF) the manipulated variable (MV) as the PV increases.
The direct action (cool control) is a control that increases (or turns ON) the manipulated variable (MV) as the PV increases.

■ Special control outputs

The control output at PV alarm and control output at READY can be set.

Item (Setting display/bank)	Display	Contents	Initial value	User level
Output operation at PV alarm (Setup setting/Setup bank)	C 15	0: Control calculation is continued. 1: Output at PV alarm is output.	0	High function
Output at PV alarm (Setup setting/Setup bank)	C 16	-10.0 to +110.0%	0.0%	High function
Output at READY (Heat) (Setup setting/Setup bank)	C 17	-10.0 to +110.0%	0.0%	Standard, High function
Output at READY (Cool) (Setup setting/Setup bank)	C 18	-10.0 to +110.0%	0.0%	Standard, High function

- When the control method is other than the ON/OFF control (Ctrl ≠ 0) and the Heat/Cool control is set enabled (C26 = 1), [Output at READY (cool): C18] can be displayed and set.
- The PV alarm status means that AL01, 02, or 03 occurs.

MANUAL mode change

The control output when the AUTO mode is changed to the MANUAL mode can be set.

Item (Setting display/bank)	Display	Contents	Initial value	User level
Output operation at changing Auto/Manual (Setup setting/Setup bank)	C 19	0: Bumpless transfer 1: Preset	0	Standard, High function
Preset MANUAL value (Setup setting/Setup bank)	C 20	-10.0 to +110.0%	0.0 or 50.0%	Standard, High function

- When [Output operation at changing Auto/Manual: C19] is set at [0: Bumpless transfer], the manipulated variable (MV) when the AUTO mode is changed to the MANUAL mode is retained. When set at [1: Preset], the manipulated variable (MV) is set to [Preset MANUAL value: C20] when the AUTO mode is changed to the MANUAL mode.
- When the control method is other than ON/OFF control (Ctrl ≠ 0), [Output operation at changing Auto/Manual: C19] and [Preset MANUAL value: C20] can be displayed and set.
- When the Heat/Cool control is not used (C26 = 0), the initial value of [Preset MANUAL value: C20] is [0.0]. On the contrary, when the Heat/Cool control is used (C26 = 1), this initial value becomes [50.0].

! Handling Precautions

When the unit is in the MANUAL mode if the power is turned ON, the set value of C20 becomes the manipulated variable (MV).

ON/OFF control

The ON/OFF control related items can be set.

Item (Setting display/bank)	Display	Contents	Initial value	User level
Differential (for ON/OFF control) (Parameter setup/Parameter bank)	dIFF	0 to 9999U	5U	Simple, Standard, High function
ON/OFF control action point offset (Parameter setup/Parameter bank)	oFFS	-1999 to +9999U	0U	High function

- [Differential (for ON/OFF control): dIFF] and [ON/OFF control action point offset: oFFS] can be displayed and set when the control method is the ON/OFF control (Ctrl = 0).
- The following Figure shows the operation of the ON/OFF control:

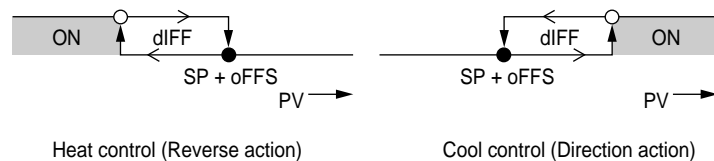

- shows that the ON/OFF is changed at this value.
- shows that the ON/OFF is changed at a point that "1U" is added to this value.

- The following describes examples showing how to use the ON/OFF control action point offset:
 To turn OFF the output at 205°C or more and turn ON the output at less than 190°C with the heat control and SP = 200°C, the differential is set to 15°C and the offset is set to 5°C.
 To turn OFF the output at 5°C or less and turn ON the output at more than 10°C with the cool control and SP = 10°C, the differential is set to 5°C and the offset is set to -5°C.

■ PID control

In the fixed PID control or ST (self-tuning), the PID control related items can be set.

Item (Setting display/bank)	Display	Contents	Initial value	User level
P (Proportional band) (Parameter setup/PID bank)	P - 1	0.1 to 999.9%	5.0%	Simple, Standard, High function
I (Integral time) (Parameter setup/PID bank)	I - 1	0 to 9999s (No integration control action when set at "0".)	120s	
D (Derivative time) (Parameter setup/PID bank)	d - 1	0 to 9999s (No derivative control action when set at "0".)	30s	
Manual reset (Parameter setup/PID bank)	rE - 1	-10.0 to +110.0%	50.0%	
MV low limit (Parameter setup/PID bank)	oL - 1	-10.0 to +110.0%	0.0%	Standard, High function
MV high limit (Parameter setup/PID bank)	oH - 1	-10.0 to +110.0%	100.0%	
P (Proportional band) (cool) (Parameter setup/PID bank)	P - 1C	0.1 to 999.9%	5.0%	Simple, Standard, High function
I (Integral time) (cool) (Parameter setup/PID bank)	I - 1C	0 to 9999s (No integration control action when set at "0".)	120s	
D (Derivative time) (cool) (Parameter setup/PID bank)	d - 1C	0 to 9999s (No derivative control action when set at "0".)	30s	
Output low limit (Cool) (Parameter setup/PID bank)	oL 1C	-10.0 to +110.0%	0.0%	Standard, High function
Output high limit (Cool) (Parameter setup/PID bank)	oH 1C	-10.0 to +110.0%	100.0%	

- When the control method is other than the ON/OFF control (Ctrl ≠ 0), the display and setting can be made.
- [(Cool)] related items can be displayed and set when using the Heat/Cool control (C26 = 1).
- When the I (Integral time) (I-1) is set at "0s" or I (Integral time) (cool) (I-1.C) is set at "0s" in the Heat/Cool control, no integration control action is performed. The Manual reset (rE-1) can be used in both the heat and cool controls.
- Parameter settings for the cool control are displayed only when the Heat/Cool control is set enabled.
- The Manual reset (rE-1) is displayed when the set value of either the I (Integral time) (heat) or (cool) becomes "0".
- The Manual reset (rE-1) is commonly used for both the heat and cool controls.
- When the I (Integral time) (heat) or (cool) is "0s", the operation is processed with both I (Integral time) (heat) and (cool) set at "0s".

■ Heat/Cool control

The Heat/Cool control related items, such as Heat/Cool, Heat/Cool control dead zone, and Heat/Cool change point can be set.

Item (Setting display/bank)	Display	Contents	Initial value	User level
Heat/Cool (Setup setting/Setup bank)	C 27	0: Normal 1: Energy saving	0	Standard, High function
Heat/Cool control dead zone (Setup setting/Setup bank)	C 28	-100.0 to +100.0%	0.0%	Simple, Standard, High function
Heat/Cool change point (Setup setting/Setup bank)	C 29	-10.0 to +110.0%	50.0%	High function

The following shows the Heat/Cool control calculation:

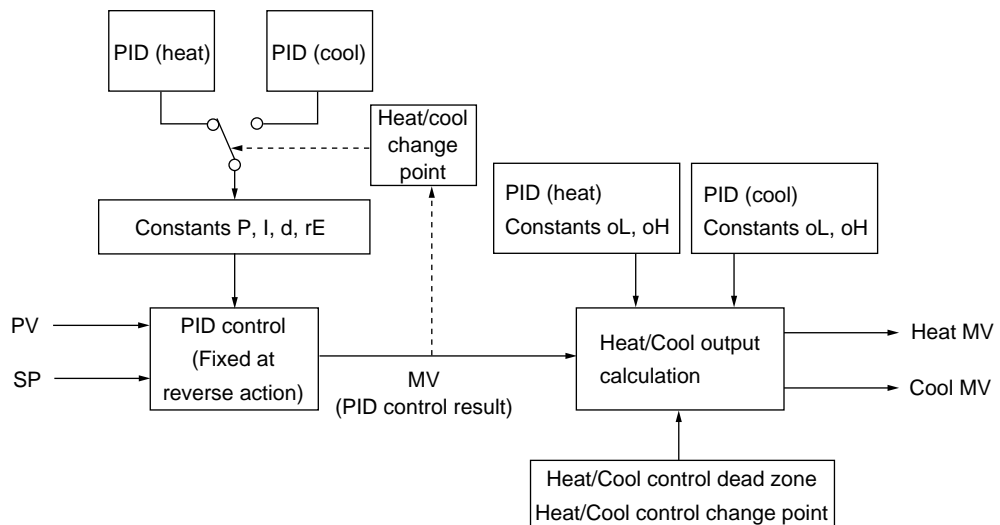

- When using the Heat/Cool control (C26 = 1), the display and setting can be made.
- When $MV \geq 50\%$, the control is changed to the PID (heat).
- When $MV < 50\%$, the control is changed to the PID (cool).
- When the heat/cool change is set at “energy saving” (C27 = 1), the heat/cool change is suppressed to indirectly obtain the energy saving effect. However, when the heat/cool dead zone (C28) is less than 0.0%, the energy saving effect cannot be obtained.
- How the relationship between the output (heat) and output (cool) is made for the PID control result (MV) is set.

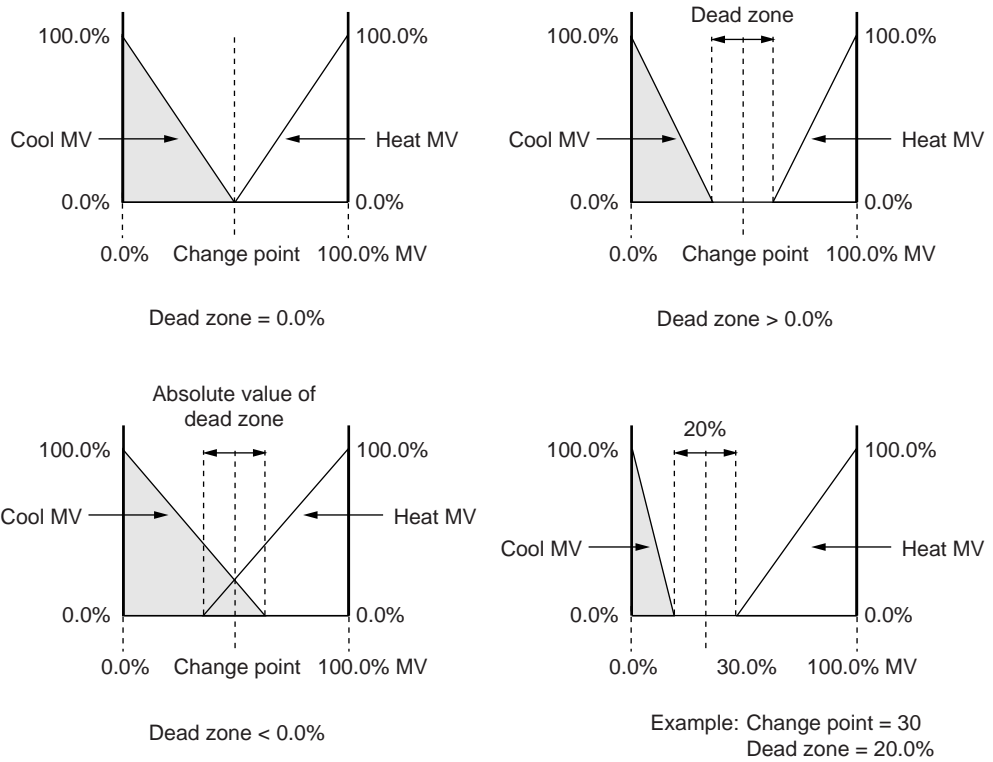

Constants oL and oH function as shown in the Figure below.

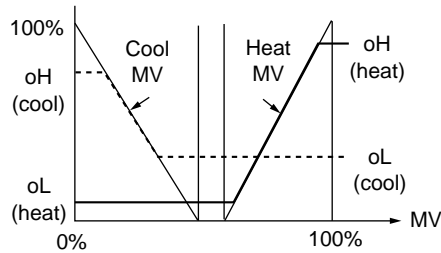

■ ST (Self-tuning)

The following ST related items can be set:

Item (Setting display/bank)	Display	Contents	Initial value	User level
ST step execution resolution width (Parameter setup/Extended tuning bank)	StSA	0.00 to 99.99%	10.00%	High function
ST step settling width (Parameter setup/Extended tuning bank)	StSb	0.0 to 10.00%	0.50%	
ST hunting settling width (Parameter setup/Extended tuning bank)	StHb	0.0 to 10.00%	1.00%	
ST step ramp change (Parameter setup/Extended tuning bank)	StUd	0: ST is executed when the PV moves up or down. 1: ST is executed only when the PV moves up.	0	Standard, High function

- When the control method is set at ST (Ctrl = 2), the display and setting can be made.
- Function of ST step execution resolution width (St.SA)
When the % value of the SP change width to the PV range is larger than the set value, the ST is started with the step response.
- Function of ST step settling width (St.Sb)
When the % value of the absolute value deviation to the PV range is smaller than the set value, this is judged as that the step response is settled in ST.
- Function of ST hunting settling width (St.Hb)
When the PV moves up or down so that the % value of the absolute value deviation to the PV range becomes larger than the set value, this is judged as hunching, and then the ST is started. After that, the % value of the absolute value deviation to the PV range becomes smaller than the set value, this is judged as that the hunching is settled.

ⓘ Handling Precautions

- For details about self-tuning, refer to
 - ➔ 5-5 ST (Self-tuning) Function
 - 5-6 Precautions for ST (Self-tuning)

■ AT (Auto-tuning)

The following AT related items can be set:

Item (Setting display/bank)	Display	Contents	Initial value	User level
MV low limit at AT (Parameter setup/Parameter bank)	At.oL	-10.0 to +110.0%	0.0%	Simple, Standard, High function
MV high limit at AT (Parameter setup/Parameter bank)	At.oH	-10.0 to +110.0%	100.0%	
AT type (Parameter setup/Extended tuning bank)	At.ty	0: Normal (Standard control characteristics) 1: Immediate response (Control characteristics that respond immediately to external disturbance.) 2: Stable (Control characteristics having less up/down fluctuation of PV)	1	
AT Proportional band adjust (Parameter setup/Extended tuning bank)	At-P	0.00 to 99.99	1.00	High function
AT Integral time adjust (Parameter setup/Extended tuning bank)	At-I	0.00 to 99.99	1.00	
AT Derivative time adjust (Parameter setup/Extended tuning bank)	At-d	0.00 to 99.99	1.00	

- When the control method is other than the ON/OFF control (Ctrl ≠ 0), the display and setting can be made.
- The MV (manipulated variable) during execution of AT can be limited by the MV low limit at AT (At.oL) and MV high limit at AT (At.oH).

When the Heat/Cool control is not used, the MV becomes a value limited by both the MV low limit at AT (At.oL)/MV high limit at AT (At.oH) and MV low limit (oL-1)/MV high limit (oH-1) of the PID constant.

When the Heat/Cool control is used, the MV becomes a value limited by the MV low limit at AT (At.oL)/MV high limit at AT (At.oH), the heat MV becomes a value limited by the MV low limit (oL-1)/MV high limit (oH-1) of the PID constant, and the cool MV becomes a value limited by the output low limit (Cool) (oL1.C)/output high limit (Cool) (oH1.C) of the PID constant.

- The AT type (At.ty) is a setting item that the PID constant of the control characteristics suitable for the system is calculated by the AT.
Set value 1 (immediate response) is adjusted to the process that the heater heating directly affects the PV to aim at the adjustment considering the immediate response.
Set value 2 (stability) is adjusted to the process that the heater heating indirectly affects the PV to aim at the adjustment considering the stability.

When compared to the AT functions of Yamatake's conventional models, set value 1 (immediate response) is close to the SDC10 and set value 0 (normal) is close to the SDC20/21.

The following Figure shows the conceptual diagram expressing differences in control result using the PID constant calculated by each AT type:

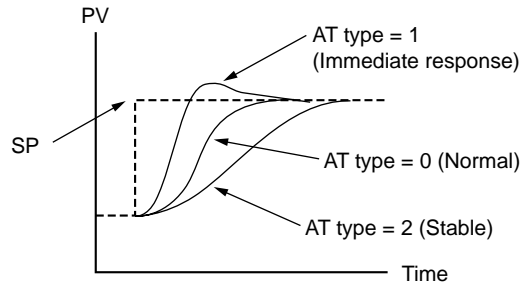

Difference in PV change when SP is changed.

- For the AT Proportional band adjust (At-P), AT Integral time adjust (At-I), and AT Derivative time adjust (At-d), the value that the PID constant calculated by the AT is multiplied by each coefficient is written into the set value of the PID constant. However, the coefficient must be a value in the PID constant setting range.

Note

- Setting that the AT is activated for only the heat PID constant in the Heat/Cool control:
 $50.0\% < \text{MV low limit at AT (At.oL)} < \text{MV high limit at AT (At.oH)}$
- Setting that the AT is activated for only the cool PID constant in the Heat/Cool control:
 $\text{MV low limit at AT (At.oL)} < \text{MV high limit at AT (At.oH)} < 50.0\%$

For details about AT,

- ☞ refer to AT stop/start (on page 5-8) and AT function (on page 5-21).

■ Just-FiTTER

This Just-FiTTER function provides the effect of the overshoot suppression and the following items can be set:

Item (Setting display/bank)	Display	Contents	Initial value	User level
Just-FiTTER overshoot limit/restraint/control coefficient (Parameter setup/Extended tuning bank)	<i>JF.ov</i>	0 to 100 (No JF function when set at "0".)	0	Standard, High function
Just-FiTTER settling band (Parameter setup/Extended tuning bank)	<i>JF.bd</i>	0.00 to 10.00%	0.30%	High function

- When the control method is other than the ON/OFF control (Ctrl ≠ 0), the display and setting can be made.
- Function of Just-FiTTER overshoot limit/restraint/control coefficient (JF.ov)
When the Just-FiTTER overshoot limit/restraint/control coefficient (JF.ov) is "0", the Just-FiTTER function becomes invalid.
When this coefficient is "1" or more, the effect of the overshoot limit/restraint/control becomes larger as the coefficient becomes larger.
- Function of Just-FiTTER settling band (JF.bd)
When the % value of the width of the absolute value deviation to the PV range is larger than the set value, the Just-FiTTER function is started. When this value is smaller than the set value, this is judged as that the PV is settled by the Just-FiTTER function.

■ RationalLOOP

This RationalLOOP function suppresses the unstable trend if the immediate response to external disturbance is increased by the high precision control logic. The following items can be set:

Item (Setting display/bank)	Display	Contents	Initial value	User level
Control algorithm (Parameter setup/Extended tuning bank)	<i>Ctrl.A</i>	0: PID (Conventional PID) 1: RationalLOOP (High-performance PID)	0	Standard, High function

- When the control method is other than the ON/OFF control (Ctrl ≠ 0), the display and setting can be made.

■ SP lag

This SP lag function suppresses changes in MV when the SP is changed. The following items can be set:

Item (Setting display/bank)	Display	Contents	Initial value	User level
SP lag time (Parameter setup/Extended tuning bank)	<i>SP.Lg</i>	0.0 to 999.9 (No effect when set at "0.0".)	0.0	High function

- When the control method is other than the ON/OFF control (Ctrl ≠ 0), the display and setting can be made.
- Function of SP lag time (SP.Lg)
When the SP lag time is set at "0.0", the SP lag function becomes invalid. When this value is "0.1" or more, changes in MV when the SP is changed become smaller and the effect of the overshoot suppression becomes larger as the value becomes larger.

5 - 4 AT (auto tuning) Function

The AT (auto tuning) function is used in the following cases:

- The PID constants are set automatically with the control method set at “Fixed PID” ([Ctrl] = 1).
- The PV rise is slow or overshoot is large in the control with the PID constants, which have been set automatically using the ST function.
- The PV rise becomes slow or overshoot becomes large with the control method set at ST ([Ctrl] = 2).

The AT function can be used when the control method is set at either “Fixed PID” ([Ctrl] = 1) or ST ([Ctrl] = 2).

■ Starting procedures

- (1) Make sure that the PV input or operation end (heater power, etc.) is controllable.
- (2) Make sure that the mode indicator [rdy] is off and the operation is in the RUN mode. If the indicator [rdy] is lit and the operation is in the READY mode, change the mode to the RUN mode.
- (3) Make sure that the mode indicator [man] is off and the operation is in the AUTO mode. If the indicator [man] is lit and the operation is in the MANUAL mode, change the mode to the AUTO mode.
- (4) Set the parameter setting [AT Stop/Start] to “AT start ([At] = [At.on])”.

■ Stopping procedures

The AT function is completed automatically. To stop the AT function, which is running, change the parameter setting [AT Stop/Start] to AT stop ([At] = [At.oF]). Additionally, the AT function is stopped when changing the READY mode to the MANUAL mode.

● Display during execution of AT

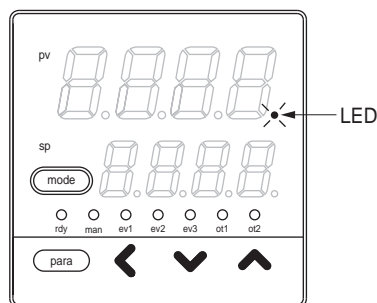

The decimal point at the 1st digit of the display No. 1 (right end digit) flashes twice repeatedly while the AT function is running. When the AT function is completed and the PID constants are changed, this LED goes off.

● Operation during execution of AT

The AT function calculates the PID constants using the limit cycle.

- (1) When the AT function is started, a point, where the SP and PV deviations are split to “2:1”, is determined as ON/OFF change point of the MV (manipulated variable).
- (2) When the limit cycle is judged as stable, the PID constants are changed and the AT function is completed.

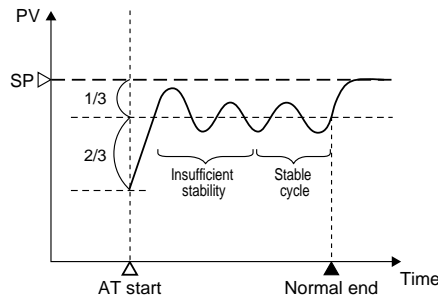

In the Heat/Cool control, the AT function is run in the status that both the heat MV and cool MV are operated.

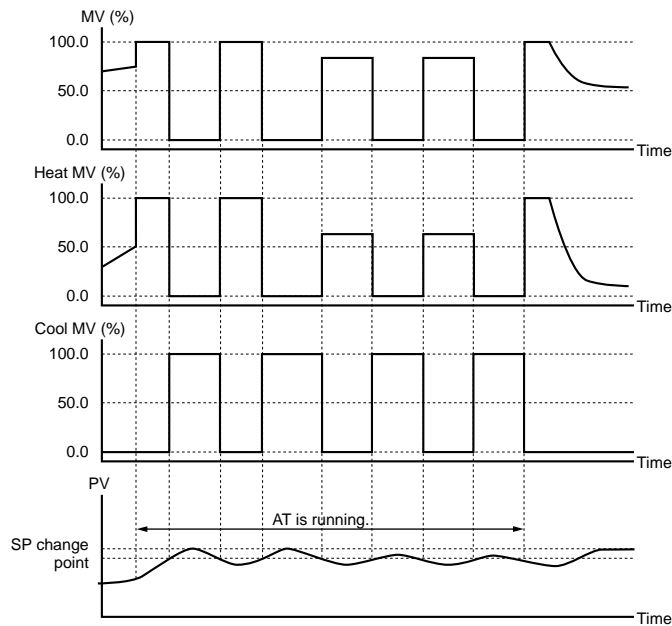

In the first half, the MV is changed to the MV low limit/MV high limit. In the latter half, the MV is changed in a slightly narrow range.

The following Figure shows an example of the AT execution when the Heat/Cool control dead zone is 0.0%, Heat/Cool control change point is 50.0%, MV low limit is 0.0%, and MV high limit is 100.0%:



! Handling Precautions

- Before starting the AT function, put the PV input and/or operation end (heater power, etc.) in the controllable status.
- When the control method is set at “ON/OFF control” ([Ctrl] = 0), the AT function cannot be started. To operate the AT function, set the control method to “Fixed PID” ([Ctrl] = 1) or “ST” ([Ctrl] = 2).
- To start the AT, it is absolutely necessary that the operation is in the READY mode and AUTO mode, and no PV input errors occur.
- If the mode is changed to the READY mode or MANUAL mode or if the PV input error or power failure occurs during execution of the AT function, the AT function is stopped without changing of the PID constants.

-
- When the Heat/Cool control is not used, the MV becomes a value limited by both ranges, one range is between the MV low limit at AT (AT.oL) and MV high limit at AT (AT.oH), and the other is between the MV low limit (oL-1) and MV high limit (oH-1) of the PID constant. When there are no common portions in two ranges, the AT function is stopped automatically.
 - When the Heat/Cool control is used, the MV becomes a value limited by the MV low limit at AT (At.oL)/MV high limit at AT (At.oH), the heat MV becomes a value limited by the MV low limit (oL-1)/MV high limit (oH-1) of the PID constant, and the cool MV becomes a value limited by the output low limit (Cool) (oL1.C)/output high limit (Cool) (oH1.C) of the PID constant.
 - When the MV low limit at AT (AT.oL)/high limit (AT.oH), MV low limit (oL-1)/high limit (oH-1), output low limit (cool) (oL1.C)/high limit (cool) (oH1.C) of the PID constant are set unevenly, the PV may not be changed up or down even though the MV is changed by the AT. In this case, the AT is kept continued. If this occurs, the AT is stopped manually, the high limit and low limit of the manipulated variable are set again, and the AT is started again.
 - The number of limit cycles and period of time from the AT start to AT end may vary depending on the control subject.
 - The MV ON and OFF are repeated several times during execution of the AT function to perform the limit cycle. (The OFF operation described here means MV limited by the MV low limit at AT ([At.oL]) or MV high limit at AT ([oL]). The default setting before shipment is "0%". Additionally, the ON operation described here means MV limited by the MV high limit at AT ([At.oH]) or MV high limit at AT ([oH]). The default setting before shipment is "100%". If this AT operation does not function correctly, take any of the following measures:
 - (1) Change the MV low limit at AT ([At.oL]) or MV high limit at AT ([At.oH]) to an appropriate value, and then start the AT function.
 - (2) Use the ST function.
 - (3) Set the PID constants manually without use of AT.
 - The AT progress value can be seen in the operation display mode. For details,
 -  refer to ■ Operation display in section 6-1, List of Operation Displays (on page 6-1).
 - When the Heat/Cool control is not used, the AT progress value decrements from [4] during execution of the AT function and becomes [0] at completion of the AT function.
 - When the Heat/Cool control is used, the AT progress value decrements from [8] during execution of the AT function and becomes [0] at completion of the AT function.
 - In both cases, the AT progress value may be "1" or "0" when the AT process is in the transient status.
 - Appropriate PID constants cannot be obtained depending on the control subject. If this happens, set the PID constants manually.
 - The MV ON/OFF change point determined when the AT function is started does not change even though the SP is changed while the AT is running.
 - For details about AT function,
 -  refer to AT Stop/Start (on page 5-8) and AT (on page 5-18).

5 - 5 ST (Self-tuning) Function

When the following ST start conditions are satisfied with the control method set at ST ([Ctrl] = 2), the ST function is started automatically to change the PID constants:

(1) ST start by SP change

If the SP is changed in the RUN mode, the ST function is started.

However, if the SP change width is small or if the difference between the SP and PV is small, the ST is not started.

(2) ST start by deviation occurrence

If the difference between the SP and PV is large during control in the RUN mode, the ST is started. If the difference between the SP and PV is large when the READY mode is changed to the RUN mode, the ST is started.

If the difference between the SP and PV is large when the control is started in the RUN mode after the power has been turned ON, the ST is started.

Handling Precautions

- To start the ST, it is necessary that the integration time of the PID constant is not "0" ($[I - 1] \neq 0$) and the derivative time is not "0" ($[d - 1] \neq 0$).
- To start the ST, it is necessary that the mode is the RUN mode and AUTO mode.
- To set the SP change width or the reference value used to judge large/small difference between the SP and PV, it is necessary to set "High function configuration". However, the default settings before shipment apply to most control subjects.
- When using the heat/cool control, the ST cannot be used.

■ Starting procedures

- (1) Make sure that the PV input or operation end (heater power, etc.) is controllable.
- (2) Make sure that the mode indicator [rdy] is off and the operation is in the RUN mode. If the indicator [rdy] is lit and the operation is in the READY mode, change the mode to the RUN mode.
- (3) Make sure that the mode indicator [man] is off and the operation is in the AUTO mode. If the indicator [man] is lit and the operation is in the MANUAL mode, change the mode to the AUTO mode.
- (4) Set the control method of the parameter setting to ST ([Ctrl] = 2).
This operation is not needed from the 2nd and subsequent operations.
- (5) Set the SP.

If the ST is not started since the PV is close to the SP ($PV \approx SP$), use the SP value, which is greatly different from the PV value.

■ Stopping procedures

The ST is completed automatically. If it is necessary to stop the ST halfway during execution of the ST or not to start the ST during stopping of the ST, set the control method of the parameter setting to “Fixed PID” (Ctrl = 1). Additionally, if the mode is changed to the READY mode or MANUAL mode, the ST is also stopped.

● Display during execution of ST

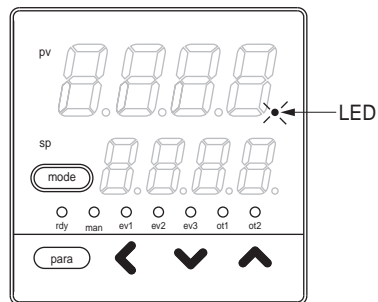

The LED of the decimal point at the 1st digit (right end digit) of the display No. 1 is flashing while the ST is running.

When the ST is completed and PID constants are changed, this LED goes off.

5 - 6 Precautions for ST (Self-tuning)

When using the ST function, the following cautions must be observed strictly:

- Before starting the ST function, put the PV input and operation end (heater power, etc.) in the controllable status.
- Before starting the ST function, set the PID constants so that the PID control can be performed correctly.
 - The default settings before shipment are that the proportional band [P-1] = 5.0%, integration time [I-1] = 120s, and derivative time [d-1] = 30s. These default settings apply to the PID control of general control subjects.
 - When the integration time [I-1] = 0s, the ST is not started.
 - When the derivative time [d-1] = 0s, the ST is not started.
- To stop the control with the power to the controller kept turned ON, change the mode to the READY mode and stop the operation at the operation end (turn OFF the heater power). Additionally, to restart the control, start the operation at the operation end (turn ON the heater power), and then change the mode to the RUN mode.

⚠ Handling Precautions

- If any cautions described above are not observed, the PID constants are changed to incorrect values when the ST is completed. This may cause poor control results.
- When the power to the controller is turned OFF while the ST is running (LED is flashing), the PID constants are not changed. Additionally, if the power is turned OFF immediately before the ST is completed, incorrect PID constant values are set.

If the PID constant values become incorrect, follow the steps below to reset them.

- (1) Return the PID constants to their default values. (Make the settings so that proportional band [P-1] = 5.0%, integration time [I-1] = 120s, and derivative time [d-1] = 30s.)
- (2) Start the ST, or set the PID constants using the AT function, and then start the ST.

● Control subject of interference system

There are adjacent control subjects in the horizontal and vertical directions. Each temperature change adversely affects the mutual ST functions and the response latency of the control may be delayed. In this case, the unit is operated with the control method set at “Fixed PID” ([Ctrl] = 1).

● Control subject producing external disturbance intermittently

If the customer’s system produces the temperature drop intermittently, such as sealing of the wrapping machine, this may affect the ST adversely.

In this case, the unit is operated with the control method set at “Fixed PID” ([Ctrl] = 1).

● Control subject producing external disturbance intermittently

When PV alarm occurrence and recovery are frequently repeated:

If PV alarm and recovery are frequently repeated while ST is running, it is judged as a hunting. And the PID parameters may be changed. When this status happens during instrumentation, set this unit to READY mode or set not to use the ST.

5 - 7 SP

The following shows the functional block diagram of the SP:

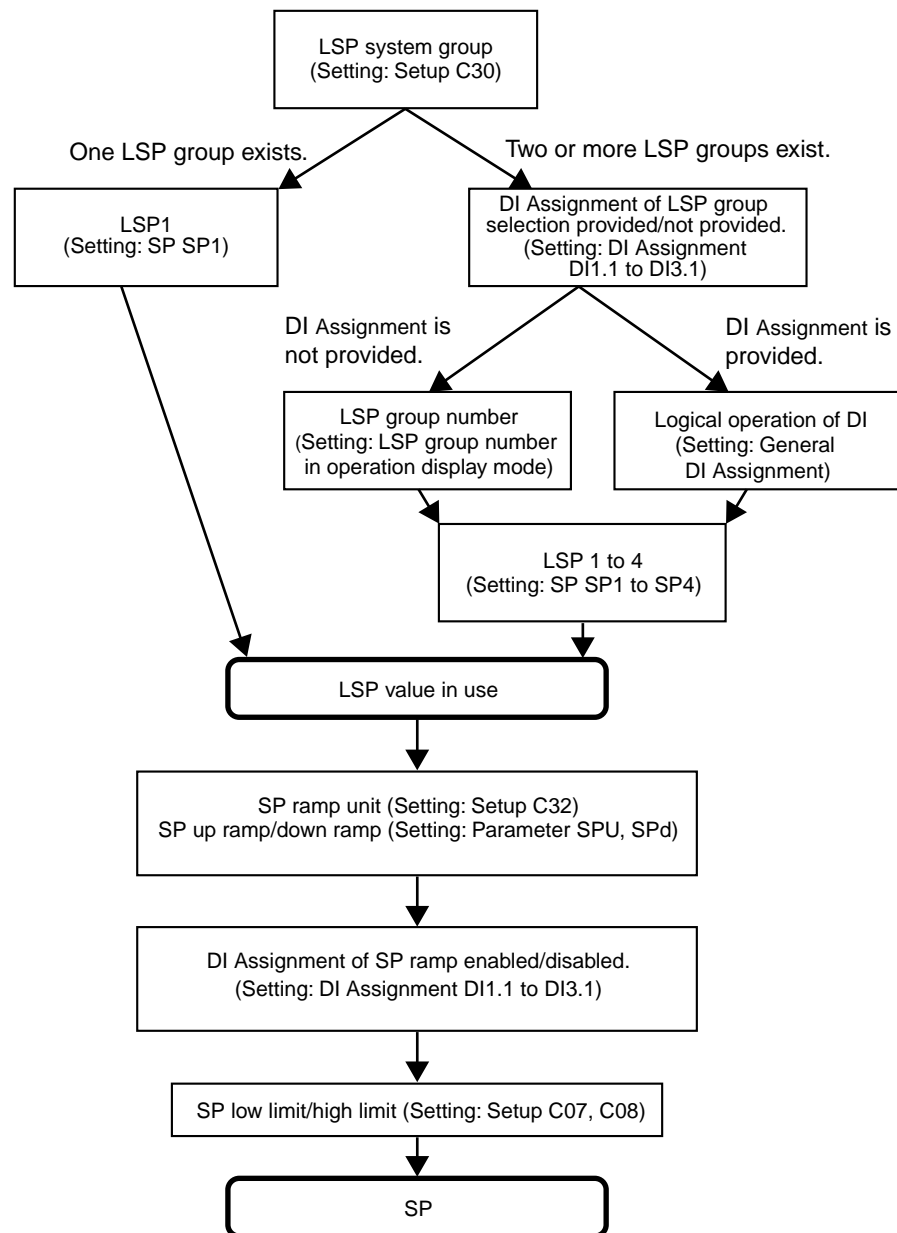

Note

LSP is a local SP and shows that the data is retained inside this unit.

On the contrary, SP by the analog input from the outside is called RSP or remote SP. However, the RSP function is not provided on this unit.

■ SP setup in operation display mode

The set value for LSP in use of LSP1 to 4 can be set.

The LSP set value is different from the SP display value during SP ramp.

However, the set value is displayed while the key is being operated to change the setting.

Item (Setting display/bank)	Display	Contents	Initial value	User level
SP (Operation display)	PV is shown on the upper display.	SP low limit to SP high limit U	0 U	Simple, Standard, High function

- When [bit 1: SP display] of the PV/SP display setup (setup C74) is set at "1" (display is provided), the display and setting can be made.

■ LSP system group

The LSP system group can be selected.

Item (Setting display/bank)	Display	Contents	Initial value	User level
LSP system group (Setup setting/Setup bank)	<i>C 30</i>	1 to 4	1	Simple, Standard, High function

■ LSP1 to 4

The set values can be set for four LSP groups.

Item (Setting display/bank)	Display	Contents	Initial value	User level
SP (Parameter setting/SP bank)	<i>SP-1</i>	SP low limit to SP high limit U	0 U	Simple, Standard, High function
	<i>SP-2</i>		0 U	
	<i>SP-3</i>		0 U	
	<i>SP-4</i>		0 U	

- The display and setting can be made for the LSP system group selected in [LSP system group] (setup C30).

■ LSP group number

The LSP group number can be set.

Item (Setting display/bank)	Display	Contents	Initial value	User level
LSP group number (Operation display)	<i>LSP</i>	Numeric value at the rightmost digit of the display. 1 to LSP system group	1	Simple, Standard, High function

- When the LSP system group (setup C30) is set at "2" or more and [bit 2: LSP group number display] of the PV/SP display setup (setup C74) is set at "1" (display is provided), the display can be made.
- When the display is possible and the DI Assignment of the LSP group selection is not performed, the setting can be made.

■ DI Assignment of LSP group selection

The LSP group selection can be set for internal contacts 1 to 3 using the DI Assignment.

Item (Setting display/bank)	Display	Contents	Initial value	User level
DI Assignment Internal Contacts 1 to 3 Operation type (Setup setting/DI Assignment bank)	di 1.1	0: No function 1: LSP group selection (0/+1)	0	Simple, Standard, High function
	di 2.1	2: LSP group selection (0/+2) 3: LSP group selection (0/+4)	0	
	di 3.1	4 to 20: Other functions	0	

- Details of LSP group selection with the internal contact function

The following shows the LSP group selection value according to the ON/OFF status of each internal contact:

LSP group selection (0/+1) OFF: 0 ON: 1

LSP group selection (0/+2) OFF: 0 ON: 2

LSP group selection (0/+4) OFF: 0 ON: 4

The value, that "1" is added to the sum of the LSP group selection values according to the ON/OFF status of each internal contact, becomes the LSP group number.

For example, when the sum of LSP group selection values of internal contact 1 to 3 is "1", the LSP group number becomes "2".

- Even though the LSP system group is "1", the display and setting can be made, but the LSP group selection with the internal contact function becomes invalid.

■ SP ramp unit

The unit of the SP up/down ramp can be set.

Item (Setting display/bank)	Display	Contents	Initial value	User level
SP ramp unit (Setup setting/Setup bank)	⌈ 32	0: 0.1U/s 1: 0.1U/min 2: 0.1U/h	0	High function

- "0.1U" shows that the decimal point position of the PV is shifted one digit rightward.

Example: When the thermocouple input is in a range of -200 to +1200°C, "0.1U" is "0.1°C".

Example: When the DC voltage input is in a range of 0.0 to 100.0, "0.1U" is "0.01".

⚠ Handling Precautions

When using the DC voltage/DC current input with setting of 3 digits after the decimal point, "0.1U" is "0.0001".

However, the SP up ramp/SP down ramp setting cannot display 4 digits after the decimal point, the value is displayed without use of the decimal point.

■ SP up ramp/down ramp

The SP up ramp and down ramp can be set.

Item (Setting display/bank)	Display	Contents	Initial value	User level
SP up ramp (Parameter setting/Parameter bank)	<i>SPU</i>	0.0U: No ramp 0.1 to 999.9U (The unit of the ramp time is selected using the SP ramp unit.)	0.0U	High function
SP down ramp (Parameter setting/Parameter bank)	<i>SPd</i>		0.0U	

- When an initial value of “0.0U” is set, the SP ramp function does not function. Therefore, when the up ramp setting is set to “0.1U” or more and the down ramp is set to “0.0U”, the SP ramp functions only during SP up and the SP ramp does not function during SP down. Additionally, the reverse operation can also be set so that the SP ramp functions only during SP up and it does not function during SP down.
- "0.1U" shows that the decimal point position of the PV is shifted one digit rightward.
Example: When the thermocouple input is in a range of -200 to +1200°C, "0.1U" is "0.1°C".
Example: When the DC voltage input is in a range of 0.0 to 100.0, "0.1U" is "0.01".
- The ramp is started assuming that the current PV value is used as start point when any of the following conditions is satisfied:
The power is turned ON.
READY+AUTO status is changed to RUN+AUTO status.
RUN+MANUAL status is changed to RUN+AUTO status.
The AT function is completed (both normal end and forced stop).

■ SP low limit/high limit

The SP low limit and high limit can be set to limit the SP range.

Item (Setting display/bank)	Display	Contents	Initial value	User level
SP low limit (Setup setting/Setup bank)	<i>[07</i>	PV input range low limit to PV input range high limit	PV input range low limit	Standard, High function
SP high limit (Setup setting/Setup bank)	<i>[08</i>	PV input range low limit to PV input range high limit	PV input range high limit	Standard, High function

⚠ Handling Precautions

When the PV input range type (setup C01) is set, the SP low limit and high limit are initialized.

■ DI Assignment of SP ramp enabled/disabled

The LSP group selection can be set for internal contacts 1 to 3 using the DI Assignment.

Item (Setting display/bank)	Display	Contents	Initial value	User level
DI Assignment Internal Contacts 1 to 3 Operation type (Setup setting/DI Assignment bank)	<i>di 1.1</i>	0: No function 13: SP ramp enabled/disabled. 1 to 12, 14 to 20: Other functions	0	Simple, Standard, High function
	<i>di 2.1</i>		0	
	<i>di 3.1</i>		0	

- Details of SP ramp enabled/disabled with internal contact function
The following shows the SP ramp enabled/disabled setting with the internal contact ON/OFF:
OFF: SP ramp enabled. ON: SP ramp disabled.
The SP ramp enabled/disabled is set for only one internal contact.
- When the SP ramp is set disabled, the SP ramp operation is stopped and the SP value becomes the final SP.

5 - 8 DI (Digital Input) and Internal Contact

The following shows the functional block diagram of the DI (digital input) and internal contact:

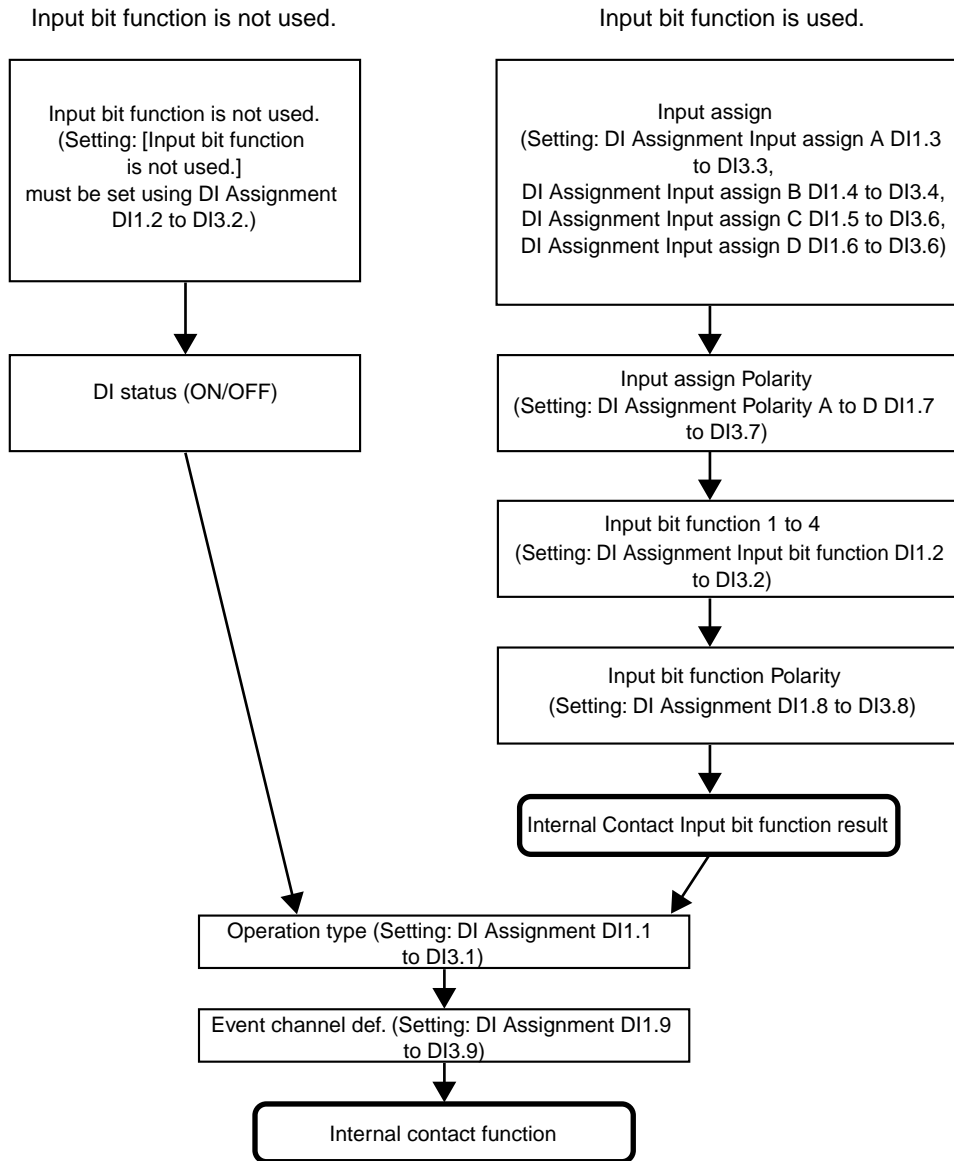

! Handling Precautions

Even though three internal contacts 1 to 3 are provided, the number of digital inputs determined by the optional model is 0 to 2 points. With the default settings before shipment, the operations of digital input 1 to 2 have already been connected to internal contacts 1 to 2. To utilize the operation of internal contact 3, it is absolutely necessary to set the DI Assignment.

■ Operation type

The operation type by the internal contact function can be set.

Item (Setting display/bank)	Display	Contents	Initial value	User level
Internal Contact 1 Operation type (Setup setting/DI Assignment bank)	di 1.1	0 to 20 For details about function by each set value, refer to the Table below.	0	Simple, Standard, High function
Internal Contact 2 Operation type (Setup setting/DI Assignment bank)	di 2.1		0	
Internal Contact 3 Operation type (Setup setting/DI Assignment bank)	di 3.1		0	

! Handling Precautions

- For [1 to 3: LSP group selection], the value that “1” is added to the sum of weights (+ 1, + 2, +4), the internal contact of which is turned ON, becomes the LSP group number.
- Do not use [14: PV value hold], [15: PV Max. hold], and [16: PV Min. hold] with they mixed.
- Do not set the same operation type other than [0: No function] and [1 to 3: LSP group selection] for multiple internal contacts.
- When using the Heat/Cool control, do not use [12: Control action direct/reverse selection].
- For timer stop/start, set a target Event channel using [Event channel def. of internal contact].

The following Table shows the contents of the dI settings:

Set value	Function	Operation at OFF	Operation at ON
0	No function	None	None
1	LSP group selection (0/+1)	LSP No.: +0	LSP No.: +1
2	LSP group selection (0/+2)	LSP No.: +0	LSP No.: +2
3	LSP group selection (0/+4)	Invalid	Invalid
4	PID group selection (0/+1)	Invalid	Invalid
5	PID group selection (0/+2)	Invalid	Invalid
6	PID group selection (0/+4)	Invalid	Invalid
7	RUN/READY mode selection	RUN	READY
8	AUTO/MANUAL mode selection	AUTO	MANUAL
9	LSP/RSP mode selection	Invalid	Invalid
10	AT (Auto tuning) Stop/Start	AT Stop	AT Start
11	ST (Self-tuning) disabled/enabled	ST disabled	ST enabled
12	Control action direct/reverse selection	Set action	Reverse action of setting
13	SP ramp enabled/disabled	SP ramp enabled	SP ramp disabled
14	PV value hold	No-hold	Hold
15	PV Max. hold	No-hold	Hold
16	PV Min. hold	No-hold	Hold
17	Timer Stop/Start	Timer stop	Timer start
18	Release all DO latches	Continue if latch exists.	Latch release
19	Advance operation	Invalid	Invalid
20	Step hold	Invalid	Invalid

■ **Event channel def.**

When the operation type is the timer start/stop, a target Event channel can be set.

Item (Setting display/bank)	Display	Contents	Initial value	User level
Internal Contact 1 Event channel def. (Setup setting/DI Assignment bank)	DI 1.9	0: Every Internal Event 1 to 5: Internal Event number	0	High function
Internal Contact 2 Event channel def. (Setup setting/DI Assignment bank)	DI 2.9		0	
Internal Contact 3 Event channel def. (Setup setting/DI Assignment bank)	DI 3.9		0	

- When the operation type of the same internal contact No. is set at “Timer stop/start”, the display and setting can be made.

■ **Input bit function**

Four kinds of input bit functions are provided. What function of four functions is used or is not used can be set.

Item (Setting display/bank)	Display	Contents	Initial value	User level
Internal Contact 1 Input bit function (Setup setting/DI Assignment bank)	DI 1.2	0: Not used (Default input) 1: Function 1 ((A and B) or (C and D)) 2: Function 2 ((A or B) and (C or D)) 3: Function 3 (A or B or C or D) 4: Function 4 (A and B and C and D)	0	High function
Internal Contact 2 Input bit function (Setup setting/DI Assignment bank)	DI 2.2		0	
Internal Contact 3 Input bit function (Setup setting/DI Assignment bank)	DI 3.2		0	

- When the set value is “0”, the input bit function is not used and the default input is used. The following shows the default input of each internal contact:
 - Internal Contact 1: DI (digital input) 1
 - Internal Contact 2: DI (digital input) 2
 - Internal Contact 3: OFF status
- In the input bit function, the logical operations (AND, OR) of each of internal contacts 1 to 3 are combined. In input bit functions 1 to 4, the combination of the logical operations may vary. The following shows one logical operation:

Logical AND	Logical OR
OFF and OFF = OFF	OFF or OFF = OFF
ON and OFF = OFF	ON or OFF = ON
ON and ON = ON	ON or ON = ON
- “OFF” is “contact open (OPEN)” or “0” when expressed using the numerical value.
- “ON” is “contact close (CLOSE)” or “1” when expressed using the numerical value.

■ Input assign

The assign of four inputs (A, B, C, D) used for the input bit function can be set.

Item (Setting display/bank)	Display	Contents	Initial value	User level
Internal Contact 1 Input assign A (Setup setting/DI Assignment bank)	d1 13	0: Normally opened. (OFF, 0) 1: Normally closed. (ON, 1) 2: DI1 3: DI2 4 to 9: Undefined.	2	High function
Internal Contact 1 Input assign B (Setup setting/DI Assignment bank)	d1 14	10: Internal Event 1 11: Internal Event 2 12: Internal Event 3 13: Internal Event 4 14: Internal Event 5 15 to 17: Undefined.	0	
Internal Contact 1 Input assign C (Setup setting/DI Assignment bank)	d1 15	18: Communication DI1 19: Communication DI2 20: Communication DI3 21: Communication DI4 22: MANUAL mode 23: READY mode 24: Undefined.	0	
Internal Contact 1 Input assign D (Setup setting/DI Assignment bank)	d1 16	25: AT running 26: During SP ramp 27: Undefined. 28: Alarm occurs. 29: PV alarm occurs. 30: Undefined.	0	
Internal Contact 2 Input assign A (Setup setting/DI Assignment bank)	d1 23	31: mode key pressing status 32: Event output 1 status 33: Control output 1 status	3	
Internal Contact 2 Input assign B (Setup setting/DI Assignment bank)	d1 24		0	
Internal Contact 2 Input assign C (Setup setting/DI Assignment bank)	d1 25		0	
Internal Contact 2 Input assign D (Setup setting/DI Assignment bank)	d1 26		0	
Internal Contact 3 Input assign A (Setup setting/DI Assignment bank)	d1 33		4	
Internal Contact 3 Input assign B (Setup setting/DI Assignment bank)	d1 34		0	
Internal Contact 3 Input assign C (Setup setting/DI Assignment bank)	d1 35		0	
Internal Contact 3 Input assign D (Setup setting/DI Assignment bank)	d1 36		0	

- When the input bit function of the same internal contact No. is set for input bit functions 1 to 4, the display and setting can be made.

■ Polarity of input assign

The polarity of four input assigns (A, B, C, D) used for the input bit function can be set.

Item (Setting display/bank)	Display	Contents	Initial value	User level
Internal Contact 1, Polarity A to D (Setup setting/DI Assignment bank)	<i>d1 1.7</i>	The digits are called 1st digit, 2nd digit, 3rd digit, and 4th digit from the right end. 1st digit: Input assign A Polarity setting 2nd digit: Input assign B Polarity setting 3rd digit: Input assign C Polarity setting 4th digit: Input assign D Polarity setting	0000	High function
Internal Contact 2, Polarity A to D (Setup setting/DI Assignment bank)	<i>d1 2.7</i>		0000	
Internal Contact 3, Polarity A to D (Setup setting/DI Assignment bank)	<i>d1 3.7</i>		0: Direct 1: Reverse	

- When the input bit function of the same internal contact No. is set for input bit functions 1 to 4, the display and setting can be made.

■ Polarity of input bit function

The polarity after the input bit function (functions 1 to 4) can be set.

Item (Setting display/bank)	Display	Contents	Initial value	User level
Internal Contact 1 Polarity (Setup setting/DI Assignment bank)	<i>d1 1.8</i>	0: Direct 1: Reverse	0	High function
Internal Contact 2 Polarity (Setup setting/DI Assignment bank)	<i>d1 2.8</i>		0	
Internal Contact 3 Polarity (Setup setting/DI Assignment bank)	<i>d1 3.8</i>		0	

■ DI Assignment setting with Smart Loader Package SLP-C35

When setting [DI Assignment] with the Smart Loader Package SLP-C35, select [Edit (E)] → [Input port setup (O)] in that order from the [Input] menu. The input bit function, input assign, polarity of input assign, and polarity of input bit function can be easily set using visual images as shown below.

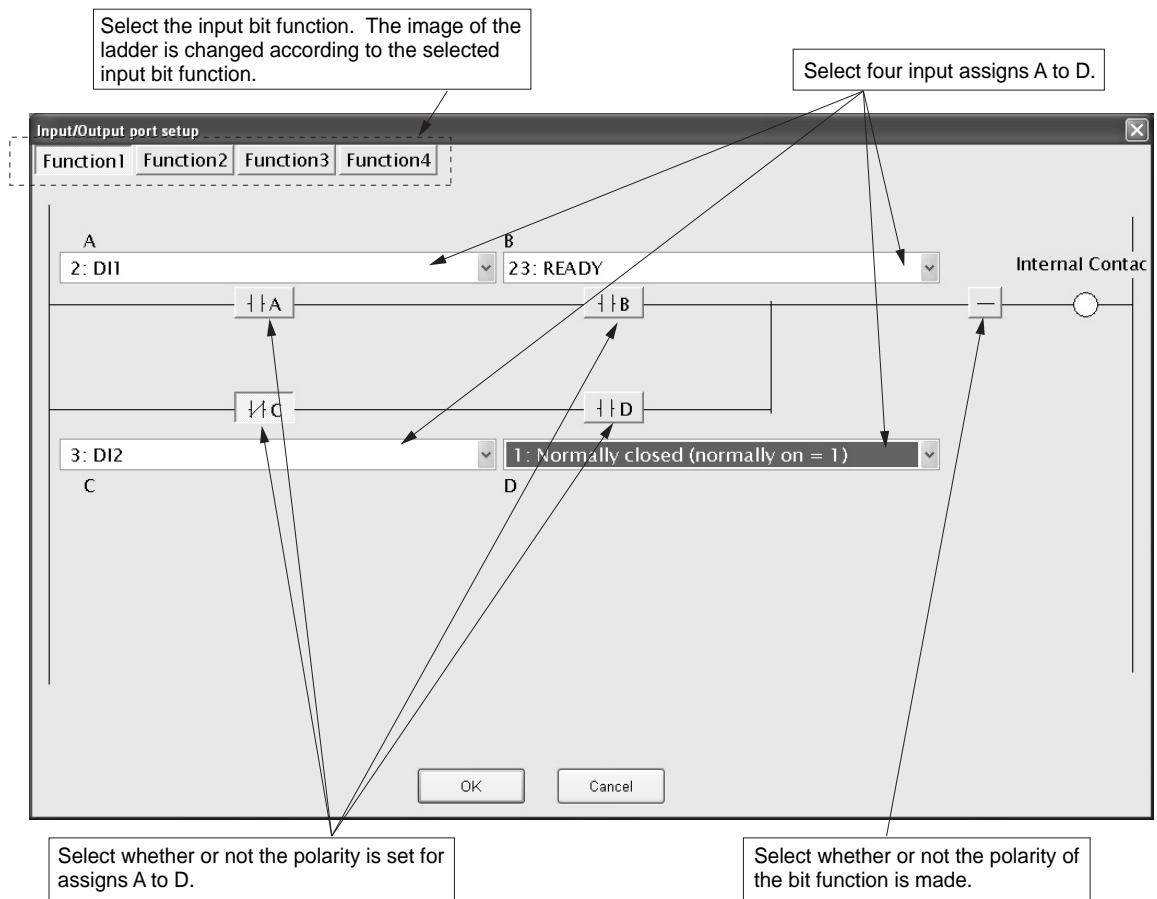

⚠ Handling Precautions

In addition to the selection through the menu, the Input port setup window can also be opened using the following procedures:

Click the input/output port setup icon .

Right-click in the input bit function setting window.

Press the [Ctrl] and [P] keys at the same time.

5 - 9 Internal Event

The result of the internal event process can be output to the control output or event output through the DO (digital output) process.

For details,

☞ refer to 2-1, Input/Output Configuration (on page 2-1).

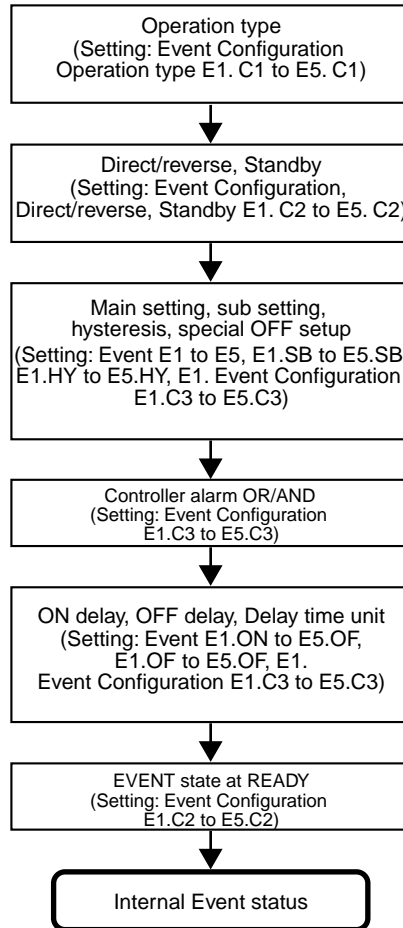

The following shows the functional block diagram of the internal event:

! Handling Precautions

Even though five internal events 1 to 5 are provided, the number of event outputs determined by the optional model is 0 to 3 points. With the default settings before shipment, the operations of internal events 1 to 3 can be output to event outputs 1 to 3. To utilize the operations of internal events 4 to 5, it is absolutely necessary to set the DO Assignment.

■ Operation

According to the operation type, direct/reverse, main setting, sub setting, hysteresis, and other settings, the operation of the internal event becomes as follows:

[List of internal event operations]



Note

For details about U (unit), refer to the attached glossary.

Operation type	Set value of operation type	Direct action ● shows that the ON/OFF is changed at this value. ○ shows that the ON/OFF is changed at a point that "1U" is added to this value.	Reverse action ● shows that the ON/OFF is changed at this value. ○ shows that the ON/OFF is changed at a point that "1U" is added to this value.
No event	0	Always OFF	Always OFF
PV high limit	1		
PV low limit	2		
PV high/low limit	3		
Deviation high limit	4		
Deviation low limit	5		
Deviation high/low limit	6		
Deviation high limit (Final SP reference)	7	Same as the direct action of the deviation high limit when the SP ramp is not used. The difference is that the SP ramp does not use the current SP, but it uses the final SP.	Same as the reverse action of the deviation high limit when the SP ramp is not used. The difference is that the SP ramp does not use the current SP, but it uses the final SP.
Deviation low limit (Final SP reference)	8	Same as the direct action of the deviation low limit when the SP ramp is not used. The difference is that the SP ramp does not use the current SP, but it uses the final SP.	Same as the reverse action of the deviation low limit when the SP ramp is not used. The difference is that the SP ramp does not use the current SP, but it uses the final SP.
Deviation high/low limit (Final SP reference)	9	Same as the direct action of the deviation high/low limit when the SP ramp is not used. The difference is that the SP ramp does not use the current SP, but it uses the final SP.	Same as the reverse action of the deviation high/low limit when the SP ramp is not used. The difference is that the SP ramp does not use the current SP, but it uses the final SP.

Chapter 5. DETAILED DESCRIPTION OF EACH FUNCTION

Operation type	Set value of operation type	Direct action ● shows that the ON/OFF is changed at this value. ○ shows that the ON/OFF is changed at a point that "1U" is added to this value.	Reverse action ● shows that the ON/OFF is changed at this value. ○ shows that the ON/OFF is changed at a point that "1U" is added to this value.
SP high limit	10		
SP low limit	11		
SP high/low limit	12		
MV high limit	13		
MV low limit	14		
MV high/low limit	15		
Heater 1 burnout/ Over-current*	16	<p>OFF before measuring the CT1 current value</p>	<p>OFF before measuring the CT1 current value</p>
Heater 1 short-circuit*	17	<p>OFF before measuring the CT1 current value</p>	<p>OFF before measuring the CT1 current value</p>
Heater 2 burnout/ Over-current*	18	<p>OFF before measuring the CT2 current value</p>	<p>OFF before measuring the CT2 current value</p>
Heater 2 short-circuit*	19	<p>OFF before measuring the CT2 current value</p>	<p>OFF before measuring the CT2 current value</p>

Operation type	Set value of operation type	Direct action	Reverse action
Loop diagnosis 1	20	<p>The event is turned ON when any change in PV corresponding to increase/decrease in MV (Manipulated variable) is not observed. This event is used to detect any fault at the operation end.</p> <ul style="list-style-type: none"> ● Setting items <ul style="list-style-type: none"> • Main setting: MV (Manipulated variable) • Sub-setting: PV • ON delay time: Diagnosis time ● Operation specifications <p>The event is turned ON when the value does not reach the PV set in the sub-setting within the diagnosis time (ON delay time) (conditions 1) even though the MV exceeding the main setting is held (conditions 2).</p> ● CAUTION <p>When setting the ON delay, it is necessary to put in "High function configuration". The default setting of the ON delay before shipment is 0.0s.</p> 	
		<p>Heat control</p> <p>ON delay is started when conditions 1 and 2 are satisfied.</p>	<p>Cool control</p> <p>ON delay is started when conditions 1 and 2 are satisfied.</p>

*: When the event type is CT1/2 heater burnout/over-current or CT1/2 heater short-circuit, the status becomes that the event judgment cannot be made from the time of power ON until that CT input current value is measured for the first time. In this case, the internal event output is OFF for both of direct action and reverse action in the direct/reverse setting. To avoid that the output becomes OFF at power ON when used in reverse action, set as follows:

(Setting example)

For direct/reverse setting of CT1/2 heater burnout/over-current or CT1/2 short-circuit event, select the direct action, and set the reverse operation in DO assignment calculation of the event output terminal (event terminal or control output terminal).

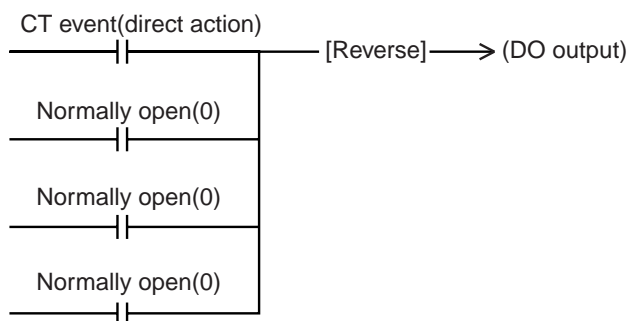

Operation type	Set value of operation type	Direct action	Reverse action
Loop diagnosis 2	21	<p>The event is turned ON when any change in PV corresponding to increase/decrease in MV (Manipulated variable) is not observed.</p> <p>This event is used to detect any fault at the operation end.</p> <ul style="list-style-type: none"> ● Setting items <ul style="list-style-type: none"> • Main setting: MV (Manipulated variable) • Sub-setting: Change in PV from the point that the MV exceeds the main setting. • ON delay time: Diagnosis time ● Operation specifications <p>The event is turned ON when the MV exceeding the main setting is held (conditions 2) and the PV does not reach the value that the sub-setting is added to (subtracted from) the PV at the point that the MV exceeds the main setting within the diagnosis time (ON delay time) (conditions 1).</p> ● CAUTION <p>When setting the ON delay, it is necessary to put in "High function configuration".</p> <p>The default setting of the ON delay before shipment is 0.0s.</p> 	<div style="display: flex; justify-content: space-between;"> <div style="width: 48%;"> <p>Heat control</p> <p>ON delay is started when conditions 1 and 2 are satisfied.</p> </div> <div style="width: 48%;"> <p>Cool control</p> <p>ON delay is started when conditions 1 and 2 are satisfied.</p> </div> </div>

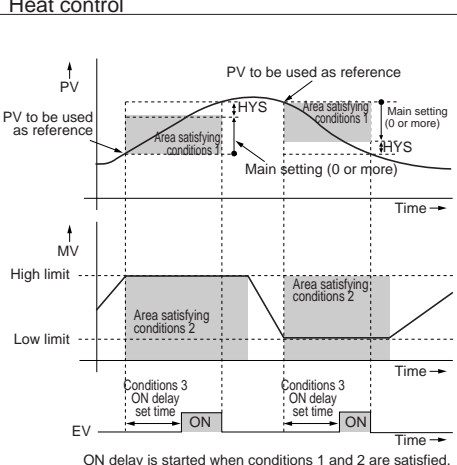
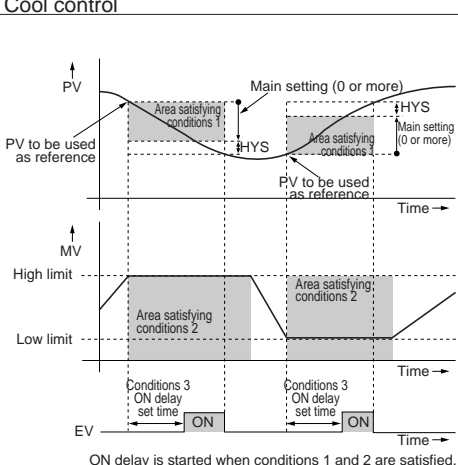
Operation type	Set value of operation type	Direct action	Reverse action
Loop diagnosis 3	22	<p>The event is turned ON when any change in PV corresponding to increase/decrease in MV (Manipulated variable) is not observed. This event is used to detect any fault at the operation end.</p> <ul style="list-style-type: none"> ● Setting items <ul style="list-style-type: none"> • Main setting: Change in PV from the point that the MV reaches the high limit (100%) or low limit (0%). • Sub-setting: Range of absolute value of deviation (PV-SP) allowing the event to turn OFF. • ON delay time: Diagnosis time • OFF delay time: A period of time from power ON allowing the event to hold OFF state. ● Operation specifications <p>The direct action is used for the heat control and is turned ON in the following cases:</p> <ul style="list-style-type: none"> • The increase in PV becomes smaller than the main setting after the diagnosis time (ON delay time) has elapsed after the MV had reached the high limit. • The decrease in PV becomes smaller than the main setting after the diagnosis time (ON delay time) has elapsed after the MV had reached the low limit. <p>The reverse action is used for the cool control and is turned ON in the following cases:</p> <ul style="list-style-type: none"> • The decrease in PV becomes smaller than the main setting after the diagnosis time (ON delay time) has elapsed after the MV had reached the high limit. • The increase in PV becomes smaller than the main setting after the diagnosis time (ON delay time) has elapsed after the MV had reached the low limit. <p>In the following cases, the event is turned OFF with the priority over the above conditions:</p> <ul style="list-style-type: none"> • The absolute value of the deviation (PV-SP) becomes less than the sub-setting. <p>However, the event is turned OFF when the absolute value of the deviation is less than the (sub setting – hysteresis) value after the absolute value of the deviation has become the sub setting or more.</p> <ul style="list-style-type: none"> • A period of time after the operation has been started by power ON is less than the OFF delay time. ● CAUTION <p>When setting the ON delay and OFF delay, it is necessary to put in " High function configuration".</p> <p>The default settings of the ON delay and OFF delay before shipment are 0.0s.</p> 	
		<p>Heat control</p>  <p>ON delay is started when conditions 1 and 2 are satisfied.</p>	<p>Cool control</p>  <p>ON delay is started when conditions 1 and 2 are satisfied.</p>

Chapter 5. DETAILED DESCRIPTION OF EACH FUNCTION

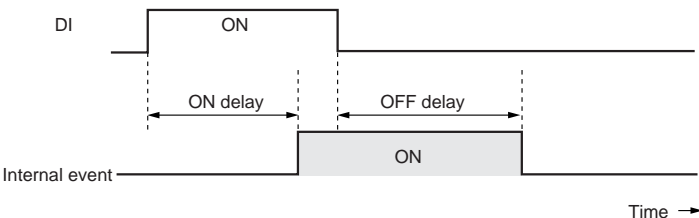
Operation type	Set value of operation type	Direct action	Reverse action
Alarm (status)	23	ON if alarm occurs (alarm code AL01 to 99). OFF in other cases.	OFF if alarm occurs (alarm code AL01 to 99). ON in other cases.
READY (status)	24	ON in the READY mode. OFF in the RUN mode.	OFF in the READY mode. ON in the RUN mode.
MANUAL (status)	25	ON in the MANUAL mode. OFF in the AUTO mode.	OFF in the MANUAL mode. ON in the AUTO mode.
Invalid	26	Always OFF	Always ON
During AT (Status)	27	ON when AT is executed. OFF when AT is stopped.	OFF when AT is executed. ON when AT is stopped.
During SP ramp	28	ON during SP ramp. OFF when SP ramp is not performed or is completed.	OFF during SP ramp. ON when SP ramp is not performed or is completed.
Control action (status)	29	ON during direct action (cooling). OFF during reverse action (heating).	OFF during direct action (cooling). ON during reverse action (heating).
ST setting standby (status)	30	ON in the ST setting standby. OFF in the ST setting completion.	OFF in the ST setting standby. ON in the ST setting completion.
Invalid	31	Always OFF	Always ON
Timer (status)	32	<p>The direct and reverse action settings are disabled for the timer event. When using the timer event, it is necessary to set the operation type of the DI assignment to "Timer Start/Stop". Additionally, when setting the event channel designation of the DI assignment, multiple timer events are controlled from individual internal contacts (DI).</p> <p>● Setting items</p> <ul style="list-style-type: none"> • ON delay time: A period of time necessary to change the event from OFF to ON after DI has been changed from OFF to ON. • OFF delay time: A period of time necessary to change the event from ON to OFF after DI has been changed from ON to OFF. <p>● Operation specifications</p> <ul style="list-style-type: none"> • The event is turned ON when DI ON continues for ON delay time or longer. • The event is turned OFF when DI OFF continues for OFF delay time. • In other cases, the current status is continued.  <p>● CAUTION</p> <p>When setting the ON delay and OFF delay, it is necessary to put in "High function configuration". The default settings of the ON delay and OFF delay before shipment are 0.0s. The default setting of the event channel designation of the DI assignment before shipment is "0". In this case, the timer event start/stop can be set for all internal events from one internal contact (DI). Additionally, as one or more event channel designation is set, the timer event start/stop can be set for one internal event specified by one internal contact (DI). However, when setting the event channel of the DI assignment, it is necessary to put in "High function configuration".</p>	

■ Operation type

The operation type of the internal event can be set.

Item (Setting display/bank)	Display	Contents	Initial value	User level
Internal Event 1 Configuration 1 Operation type (Setup setting/Event Configuration bank)	E 1C 1	0: No event 1: PV high limit 2: PV low limit 3: PV high/low limit 4: Deviation high limit 5: Deviation low limit	0	Simple, Standard, High function
Internal Event 2 Configuration 1 Operation type (Setup setting/Event Configuration bank)	E 2C 1	6: Deviation high/low limit 7: Deviation high limit (Final SP reference) 8: Deviation low limit (Final SP reference)	0	
Internal Event 3 Configuration 1 Operation type (Setup setting/Event Configuration bank)	E 3C 1	9: Deviation high/low limit (Final SP reference) 10: SP high limit 11: SP low limit 12: SP high/low limit 13: MV high limit	0	
Internal Event 4 Configuration 1 Operation type (Setup setting/Event Configuration bank)	E 4C 1	14: MV low limit 15: MV high/low limit 16: CT1 heater burnout/over-current 17: CT1 heater short-circuit 18: CT2 heater burnout/over-current 19: CT2 heater short-circuit	0	
Internal Event 5 Configuration 1 Operation type (Setup setting/Event Configuration bank)	E 5C 1	20: Loop diagnosis 1 21: Loop diagnosis 2 22: Loop diagnosis 3 23: Alarm (status) 24: READY (status) 25: MANUAL (status) 26: Invalid 27: During AT execution (status) 28: During SP ramp (status) 29: Control direct action (status) 30: During ST execution (status) 31: Invalid 32: Timer (status)	0	

■ Direct/reverse, standby, and EVENT state at READY

Direct/reverse, standby, and EVENT state at READY accompanying with the operation type can be set.

Item (Setting display/bank)	Display	Contents	Initial value	User level
Internal Event 1 Configuration 2 Operation type (Setup setting/Event Configuration bank)	E 1.C 2	The digits are called 1st digit, 2nd digit, 3rd digit, and 4th digit from the right end. 1st digit: Direct/reverse setup 0: Direct 1: Reverse	0000	Simple, Standard, High function
Internal Event 2 Configuration 2 Operation type (Setup setting/Event Configuration bank)	E 2.C 2	2nd digit: Standby setup 0: None 1: Standby 2: Standby + Standby at SP change 3rd digit: EVENT state at READY setup 0: Continued. 1: Forced OFF	0000	
Internal Event 3 Configuration 2 Operation type (Setup setting/Event Configuration bank)	E 3.C 2	4th digit: Undefined. 0: Undefined.	0000	
Internal Event 4 Configuration 2 Operation type (Setup setting/Event Configuration bank)	E 4.C 2		0000	
Internal Event 5 Configuration 2 Operation type (Setup setting/Event Configuration bank)	E 5.C 2		0000	

- When the internal event configuration 1 operation type is set at [0: No event], the internal event configuration 2 (direct/reverse, standby, and EVENT state at READY) is not displayed.
- For details about internal event operation with the direct/reverse setting,  refer to the List of internal event operations (on pages 5-39 to 5-41).

 Handling Precautions

- “Standby” is a function that does not turn ON the event even though the event currently used satisfies the ON conditions (before polarity) when the instrument power is turned ON or when the READY mode is changed to the RUN mode. The event is turned ON when the ON conditions are satisfied again once the OFF conditions have been satisfied.
- “Standby + Standby at SP change” means that the standby is set again when the SP is changed (SP value and LSP group number) in addition to the standby functions. However, when the same SP value is written or when the SP value is not changed even though the LSP group number is changed, the unit does not enter the standby mode.

■ Alarm OR, special OFF setup, and delay time unit

Alarm OR, special OFF setup, and delay time unit accompanying with the operation type can be set.

Item (Setting display/bank)	Display	Contents	Initial value	User level
Internal Event 1 Configuration 3 Operation type (Setup setting/Event Configuration bank)	E 1 C 3	The digits are called 1st digit, 2nd digit, 3rd digit, and 4th digit from the right end. 1st digit: Alarm OR setup 0: None 1: Alarm direct + OR operation 2: Alarm direct + AND operation 3: Alarm reverse + OR operation 4: Alarm reverse + AND operation	0000	High function
Internal Event 2 Configuration 3 Operation type (Setup setting/Event Configuration bank)	E 2 C 3	2nd digit: Special OFF setup 0: As usual. 1: When EV main setting is "0", the event is set to "OFF".	0000	
Internal Event 3 Configuration 3 Operation type (Setup setting/Event Configuration bank)	E 3 C 3	3rd digit: Delay time unit setup 0: 0.1s 1: 1s 2: 1 min.	0000	
Internal Event 4 Configuration 3 Operation type (Setup setting/Event Configuration bank)	E 4 C 3	4th digit: Undefined. 0: Undefined.	0000	
Internal Event 5 Configuration 3 Operation type (Setup setting/Event Configuration bank)	E 5 C 3		0000	

- When the internal event configuration 1 operation type is set at [0: No event], the internal event configuration 3 (alarm OR, special OFF setup, and delay time unit) is not displayed.

The following shows the relationship among alarm OR setting, alarm present/not present, and internal event ON/OFF:

Alarm OR setting	Alarm (AL01 to 99) present/not present	Internal event ON/OFF status before alarm OR process	Internal event ON/OFF status after alarm OR process
None	Not present	OFF	OFF
	Not present	ON	ON
	Present.	OFF	OFF
	Present.	ON	ON
Alarm direct + OR operation	Not present	OFF	OFF
	Not present	ON	ON
	Present.	OFF	ON
	Present.	ON	ON
Alarm direct + AND operation	Not present	OFF	OFF
	Not present	ON	OFF
	Present.	OFF	OFF
	Present.	ON	ON
Alarm reverse + OR operation	Not present	OFF	ON
	Not present	ON	ON
	Present.	OFF	OFF
	Present.	ON	ON
Alarm reverse + AND operation	Not present	OFF	OFF
	Not present	ON	ON
	Present.	OFF	OFF
	Present.	ON	OFF

■ Main setting, sub setting, and hysteresis

Main setting, sub setting, and hysteresis accompanying with the operation type can be set.

Item (Setting display/bank)	Display	Contents	Initial value	User level
Internal Event 1 Main setting (Parameter setting/Event bank)	<i>E 1</i>	-1999 to +9999 The decimal point position may vary so that it meets the operation type. The above value becomes 0 to 9999 in some operation types.	0	Simple, Standard, High function
Internal Event 1 Sub setting (Parameter setting/Event bank)	<i>E 1.5b</i>	-1999 to +9999 The decimal point position may vary so that it meets the operation type. The above value becomes 0 to 9999 in some operation types.	0	
Internal Event 1 Hysteresis (Parameter setting /Event bank)	<i>E 1.HY</i>	0 to 9999 The decimal point position may vary so that it meets the operation type.	5	Standard, High function
Internal Event 2 Main setting (Parameter setting/Event bank)	<i>E 2</i>	Same as Internal Event 1 Main setting.	0	Simple, Standard, High function
Internal Event 2 Sub setting (Parameter setting/Event bank)	<i>E 2.5b</i>	Same as Internal Event 1 Sub setting.	0	
Internal Event 2 Hysteresis (Parameter setting /Event bank)	<i>E 2.HY</i>	Same as Internal Event 1 Hysteresis.	5	Standard, High function
Internal Event 3 Main setting (Parameter setting/Event bank)	<i>E 3</i>	Same as Internal Event 1 Main setting.	0	Simple, Standard, High function
Internal Event 3 Sub setting (Parameter setting/Event bank)	<i>E 3.5b</i>	Same as Internal Event 1 Sub setting.	0	
Internal Event 3 Hysteresis (Parameter setting /Event bank)	<i>E 3.HY</i>	Same as Internal Event 1 Hysteresis.	5	Standard, High function
Internal Event 4 Main setting (Parameter setting/Event bank)	<i>E 4</i>	Same as Internal Event 1 Main setting.	0	Simple, Standard, High function
Internal Event 4 Sub setting (Parameter setting/Event bank)	<i>E 4.5b</i>	Same as Internal Event 1 Sub setting.	0	
Internal Event 4 Hysteresis (Parameter setting /Event bank)	<i>E 4.HY</i>	Same as Internal Event 1 Hysteresis.	5	Standard, High function
Internal Event 5 Main setting (Parameter setting/Event bank)	<i>E 5</i>	Same as Internal Event 1 Main setting.	0	Simple, Standard, High function
Internal Event 5 Sub setting (Parameter setting/Event bank)	<i>E 5.5b</i>	Same as Internal Event 1 Sub setting.	0	
Internal Event 5 Hysteresis (Parameter setting /Event bank)	<i>E 5.HY</i>	Same as Internal Event 1 Hysteresis.	5	Standard, High function

- When the internal event configuration 1 operation type is set at [0: No event], the internal event main setting, sub setting, and hysteresis are not displayed.
- For details about internal event operation with main setting, sub setting, and hysteresis,
 refer to the List of internal event operations (on pages 5-39 to 5-41).

■ ON delay and OFF delay

ON delay is a function that delays the timing, at which the internal event status is changed from OFF to ON.

OFF delay is a function that delays the timing, at which the internal event status is changed from ON to OFF.

However, when the operation type is set at [20: Loop diagnosis 1], [21: Loop diagnosis 2], [22: Loop diagnosis 3], or [32: Timer], the ON delay and OFF delay are operated as another function.

For details,

 refer to the List of internal event operations (on pages 5-39 to 5-41).

ON delay and OFF delay can be set.

Item (Setting display/bank)	Display	Contents	Initial value	User level
Internal Event 1 ON delay (Parameter setting/Event bank)	<i>E 1on</i>	0.0 to 999.9s (Delay time unit is "0.1s".) 0 to 9999s (Delay time unit is other than "0.1s".)	0.0s or 0s	High function
Internal Event 1 OFF delay (Parameter setting/Event bank)	<i>E 1oF</i>	0.0 to 999.9s (Delay time unit is "0.1s".) 0 to 9999s (Delay time unit is other than "0.1s".)	0.0s or 0s	
Internal Event 2 ON delay (Parameter setting/Event bank)	<i>E 2on</i>	0.0 to 999.9s (Delay time unit is "0.1s".) 0 to 9999s (Delay time unit is other than "0.1s".)	0.0s or 0s	
Internal Event 2 OFF delay (Parameter setting/Event bank)	<i>E 2oF</i>	0.0 to 999.9s (Delay time unit is "0.1s".) 0 to 9999s (Delay time unit is other than "0.1s".)	0.0s or 0s	
Internal Event 3 ON delay (Parameter setting/Event bank)	<i>E 3on</i>	0.0 to 999.9s (Delay time unit is "0.1s".) 0 to 9999s (Delay time unit is other than "0.1s".)	0.0s or 0s	
Internal Event 3 OFF delay (Parameter setting/Event bank)	<i>E 3oF</i>	0.0 to 999.9s (Delay time unit is "0.1s".) 0 to 9999s (Delay time unit is other than "0.1s".)	0.0s or 0s	
Internal Event 4 ON delay (Parameter setting/Event bank)	<i>E 4on</i>	0.0 to 999.9s (Delay time unit is "0.1s".) 0 to 9999s (Delay time unit is other than "0.1s".)	0.0s or 0s	
Internal Event 4 OFF delay (Parameter setting/Event bank)	<i>E 4oF</i>	0.0 to 999.9s (Delay time unit is "0.1s".) 0 to 9999s (Delay time unit is other than "0.1s".)	0.0s or 0s	

Chapter 5. DETAILED DESCRIPTION OF EACH FUNCTION

Item (Setting display/bank)	Display	Contents	Initial value	User level
Internal Event 5 ON delay (Parameter setting/Event bank)	<i>E5.0n</i>	0.0 to 999.9s (Delay time unit is "0.1s".) 0 to 9999s (Delay time unit is other than "0.1s".)	0.0s or 0s	High function
Internal Event 5 OFF delay (Parameter setting/Event bank)	<i>E5.0F</i>	0.0 to 999.9s (Delay time unit is "0.1s".) 0 to 9999s (Delay time unit is other than "0.1s".)	0.0s or 0s	

- When the internal event configuration 1 operation type is set at [0: No event], the internal event ON delay and OFF delay are not displayed.

5 - 10 DO (Digital Output)

The following shows the functional block diagram of the DO (digital output):

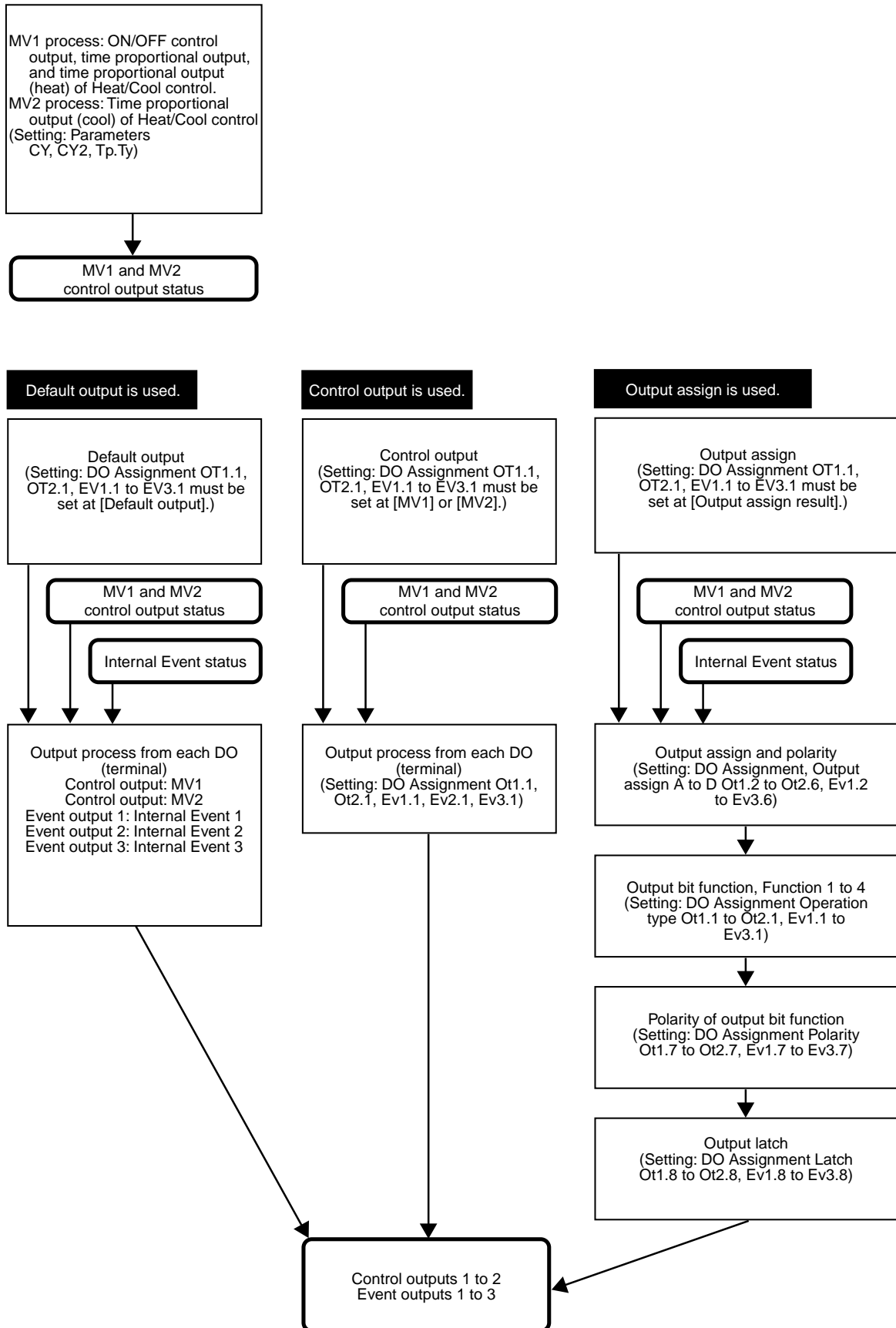

■ **MV1/MV2 process**

The Time proportional cycle and time proportional cycle mode of MV1/MV2 can be set.

Item (Setting display/bank)	Display	Contents	Initial value	User level
Time proportional cycle 1 (For MV1) (Parameter setting/Parameter bank)	CY	5 to 120s (Output includes the relay output.) 1 to 120s (Output does not include the relay output.)	10 or 2s	Simple, Standard, High function
Time proportional cycle 2 (For MV2) (Parameter setting/Parameter bank)	CY2		10 or 2s	
Time proportional cycle mode (Parameter setting/Parameter bank)	TPCY	0: Controllability aiming type 1: Operation service life aiming type (ON/OFF operation is performed only once within the Time proportional cycle.)	0 or 1	High function

- MV1 is a general name of the ON/OFF control output, time proportional output, and time proportional output (heat) of the Heat/Cool control.
MV2 is the time proportional output (cool) of the Heat/Cool control.
- When MV1 is connected to any of the relay control output, voltage pulse control output, and event output in the DO Assignment, the display and setting of the Time proportional cycle 1 (Cy) can be made.
- When the Heat/Cool control is used and MV2 is connected to any of the relay control output, voltage pulse control output, and event output in the DO Assignment, the display and setting of the Time proportional cycle 2 (Cy2) can be made.
- The initial value of the Time proportional cycle 1 (Cy) is “10” when the control output 1 is the relay output and it is “2” in other cases.
- The initial value of the Time proportional cycle 2 (Cy2) is “10” when a model with one control output point is used and it is “2” when other models are used.
- The setting of the time proportional cycle mode (tp.ty) is valid to the time proportional outputs of both MV1 and MV2.
- When MV1 is connected to the relay control output or event output in the DO Assignment and the Time proportional cycle 1 (Cy) is set at less than “5s”, the operation is performed at intervals of 5s.
- When MV2 is connected to the relay control output or event output in the DO Assignment and the Time proportional cycle 2 (Cy2) is set at less than “5s”, the operation is performed at intervals of 5s.

■ Operation type

The outputs of the control outputs 1 to 2 and event outputs 1 to 3 can be set using the operation type of the DO Assignment.

Item (Setting display/bank)	Display	Contents	Initial value	User level
Control output 1 Operation type (Setup setting/DO bank)	ot 1.1	0: Default output 1: MV1 2: MV2 3: Function 1 ((A and B) or (C and D)) 4: Function 2 ((A or B) and (C or D)) 5: Function 3 (A or B or C or D) 6: Function 4 (A and B and C and D)	0	High function
Control output 2 Operation type (Setup setting/DO bank)	ot 2.1		0	
Event output 1 Operation type (Setup setting/DO bank)	Ev 1.1		0	
Event output 2 Operation type (Setup setting/DO bank)	Ev 2.1		0	
Event output 3 Operation type (Setup setting/DO bank)	Ev 3.1		0	

- When the object control output is the relay output or voltage pulse output, the display and setting can be made.
- When the object event output is provided, the display and setting can be made.
- MV1 is the ON/OFF control output, time proportional output, and time proportional output (heat) of the Heat/Cool control.
- MV2 is the time proportional output (cool) of the Heat/Cool control.
- When the set value is “0” (default output), the operation becomes as follows according to the output:
 - Control output 1: Control output status of MV1 is output.
 - Control output 2: Control output status of MV2 is output.
 - Event output 1: Result of Internal Event 1 is output.
 - Event output 2: Result of Internal Event 2 is output.
 - Event output 3: Result of Internal Event 3 is output.
- In the output bit function, the logical operations (AND, OR) of each control output and each event output are combined. In output bit functions 1 to 4, the combination of the logical operations may vary. The following shows one logical operation:

Logical AND	Logical OR
OFF and OFF = OFF	OFF or OFF = OFF
OFF and ON = OFF	OFF or ON = ON
ON and OFF = OFF	ON or OFF = ON
ON and ON = ON	ON or ON = ON

■ Output assign

The assign of four inputs (A, B, C, D) used for the output bit function can be set.

Item (Setting display/bank)	Display	Contents	Initial value	User level
Control output 1 Output assign A (Setup setting/DO Assignment bank)	ot 1.2	0: Normally opened. (OFF, 0) 1: Normally closed. (ON, 1) 2: Internal Event 1	14	High function
Control output 1 Output assign B (Setup setting/DO Assignment bank)	ot 1.3	3: Internal Event 2 4: Internal Event 3 5: Internal Event 4 6: Internal Event 5	0	
Control output 1 Output assign C (Setup setting/DO Assignment bank)	ot 1.4	7 to 13: Undefined. 14: MV1 15: MV2	0	
Control output 1 Output assign D (Setup setting/DO Assignment bank)	ot 1.5	16 to 17: Undefined. 18: DI1 19: DI2 20 to 25: Undefined.	0	
Control output 2 Output assign A (Setup setting/DO Assignment bank)	ot 2.2	26: Internal Contact 1 27: Internal Contact 2 28: Internal Contact 3	15	
Control output 2 Output assign B (Setup setting/DO Assignment bank)	ot 2.3	29 to 33: Undefined. 34: Communication DI1 35: Communication DI2 36: Communication DI3	0	
Control output 2 Output assign C (Setup setting/DO Assignment bank)	ot 2.4	37: Communication DI4 38: MANUAL mode 39: READY mode	0	
Control output 2 Output assign D (Setup setting/DO Assignment bank)	ot 2.5	40: Undefined. 41: AT running 42: During SP ramp 43: Undefined.	0	
Event output 1 Output assign A (Setup setting/DO Assignment bank)	Ev 1.2	44: Alarm occurs. 45: PV alarm occurs. 46: Undefined.	2	
Event output 1 Output assign B (Setup setting/DO Assignment bank)	Ev 1.3	47: mode key pressing status 48: Event output 1 status 49: Control output 1 status	0	
Event output 1 Output assign C (Setup setting/DO Assignment bank)	Ev 1.4		0	
Event output 1 Output assign D (Setup setting/DO Assignment bank)	Ev 1.5		0	

Item (Setting display/bank)	Display	Contents	Initial value	User level
Event output 2 Output assign A (Setup setting/DO Assignment bank)	<i>Ev2.2</i>	Same as those on the previous page.	3	Same as that on the previous page.
Event output 2 Output assign B (Setup setting/DO Assignment bank)	<i>Ev2.3</i>		0	
Event output 2 Output assign C (Setup setting/DO Assignment bank)	<i>Ev2.4</i>		0	
Event output 2 Output assign D (Setup setting/DO Assignment bank)	<i>Ev2.5</i>		0	
Event output 3 Output assign A (Setup setting/DO Assignment bank)	<i>Ev3.2</i>		4	
Event output 3 Output assign B (Setup setting/DO Assignment bank)	<i>Ev3.3</i>		0	
Event output 3 Output assign C (Setup setting/DO Assignment bank)	<i>Ev3.4</i>		0	
Event output 3 Output assign D (Setup setting/DO Assignment bank)	<i>Ev3.5</i>		0	

- When the object control output is the relay output or voltage pulse output, and the operation type of the DO Assignment is set for output bit functions 1 to 4, the display and setting can be made.
- When the object event output is provided and the operation type of the DO Assignment is set for output bit functions 1 to 4, the display and setting can be made.

■ Polarity of output assign

The polarity of four output assigns (A, B, C, D) used for the output bit function can be set.

Item (Setting display/bank)	Display	Contents	Initial value	User level
Control output 1 Polarity A to D (Setup setting/DO Assignment bank)	ot 1.6	The digits are called 1st digit, 2nd digit, 3rd digit, and 4th digit from the right end. 1st digit: Output assign A Polarity setting 2nd digit: Output assign B Polarity setting 3rd digit: Output assign C Polarity setting 4th digit: Output assign D Polarity setting	0000	High function
Control output 2 Polarity A to D (Setup setting/DO Assignment bank)	ot 2.6		0000	
Event output 1 Polarity A to D (Setup setting/DO Assignment bank)	Ev 1.6		0000	
Event output 2 Polarity A to D (Setup setting/DO Assignment bank)	Ev 2.6		0000	
Event output 3 Polarity A to D (Setup setting/DO Assignment bank)	Ev 3.6		0000	

- When the object control output is the relay output or voltage pulse output, and the operation type of the DO Assignment is set for output bit functions 1 to 4, the display and setting can be made.
- When the object event output is provided and the operation type of the DO Assignment is set for output bit functions 1 to 4, the display and setting can be made.

ⓘ Handling Precautions

The output relay may be turned ON and OFF repeatedly at a high-speed depending on the conditions.

To avoid such faulty operation, always strictly observe the following cautions:

Control output 1: When any of [Output assign A, B, C, D] (ot1.2 to ot1.5) is set at [49: Control output 1 status], do not set [1: Reverse] for the same symbol of [Output assign A, B, C, D Polarity].

Event output 1: When any of [Output assign A, B, C, D] (ev1.2 to ot1.5) is set at [48: Event output 1 status], do not set [1: Reverse] for the same symbol of [Output assign A, B, C, D Polarity].

■ Polarity of output bit function

The polarity after the output bit function (functions 1 to 4) can be set.

Item (Setting display/bank)	Display	Contents	Initial value	User level
Control output 1 Polarity (Setup setting/DO Assignment bank)	ot 1.7	0: Direct 1: Reverse	0	High function
Control output 2 Polarity (Setup setting/DO Assignment bank)	ot 2.7		0	
Event output 1 Polarity (Setup setting/DO Assignment bank)	Ev 1.7		0	
Event output 2 Polarity (Setup setting/DO Assignment bank)	Ev 2.7		0	
Event output 3 Polarity (Setup setting/DO Assignment bank)	Ev 3.7		0	

- When the object control output is the relay output or voltage pulse output, and the operation type of the DO Assignment is set for output bit functions 1 to 4, the display and setting can be made.
- When the object event output is provided and the operation type of the DO Assignment is set for output bit functions 1 to 4, the display and setting can be made.

■ Latch

The latch of the output ON status or output OFF status can be set.

Item (Setting display/bank)	Display	Contents	Initial value	User level
Control output 1 Latch (Setup setting/DO Assignment bank)	ot 1.8	0: None 1: Latched (Latched when turned ON.) 2: Latched (Latched when turned OFF except for initialization at power ON.)	0	High function
Control output 2 Latch (Setup setting/DO Assignment bank)	ot 2.8		0	
Event output 1 Latch (Setup setting/DO Assignment bank)	Ev 1.8		0	
Event output 2 Latch (Setup setting/DO Assignment bank)	Ev 2.8		0	
Event output 3 Latch (Setup setting/DO Assignment bank)	Ev 3.8		0	

- When the object control output is the relay output or voltage pulse output, and the operation type of the DO Assignment is set for output bit functions 1 to 4, the display and setting can be made.
- When the object event output is provided and the operation type of the DO Assignment is set for output bit functions 1 to 4, the display and setting can be made.
- To release the latch status, it is necessary to turn OFF the power, and turn it ON again, to release all DO latches (key operation or communication), or to change the latch setting of the DO Assignment to “0” (none).

■ DO Assignment setting with Smart Loader Package SLP-C35

When setting [DO Assignment] with the Smart Loader Package SLP-C35, select [Edit (E)] → [Input/Output port setup (O)] in that order from the menu. The output bit function, output assign, polarity of output assign, and polarity of output bit function can be easily set using visual images as shown below.

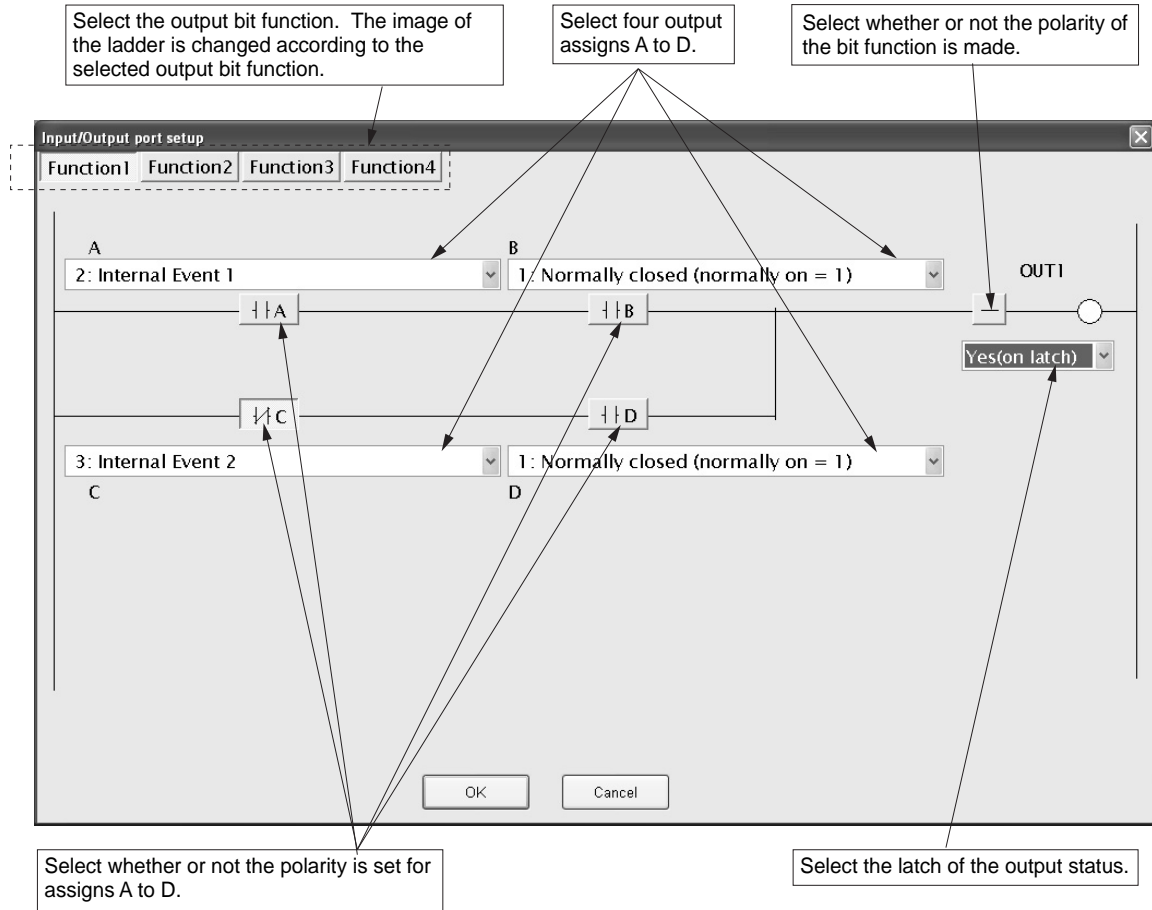

⚠ Handling Precautions

In addition to the selection through the menu, the Input port setup window can also be opened using the following procedures:

Click the input/output port setup icon .

Right-click in the input bit function setting window.

Press the [Ctrl] and [P] keys at the same time.

5 - 11 Application Examples

This section describes examples of applications using the assign functions of this unit.

■ Examples of applications using assign functions

The following shows setting examples with the Smart Loader Package SLP-C35. To use assign functions, it is absolutely necessary to set the user level to “High function configuration”.

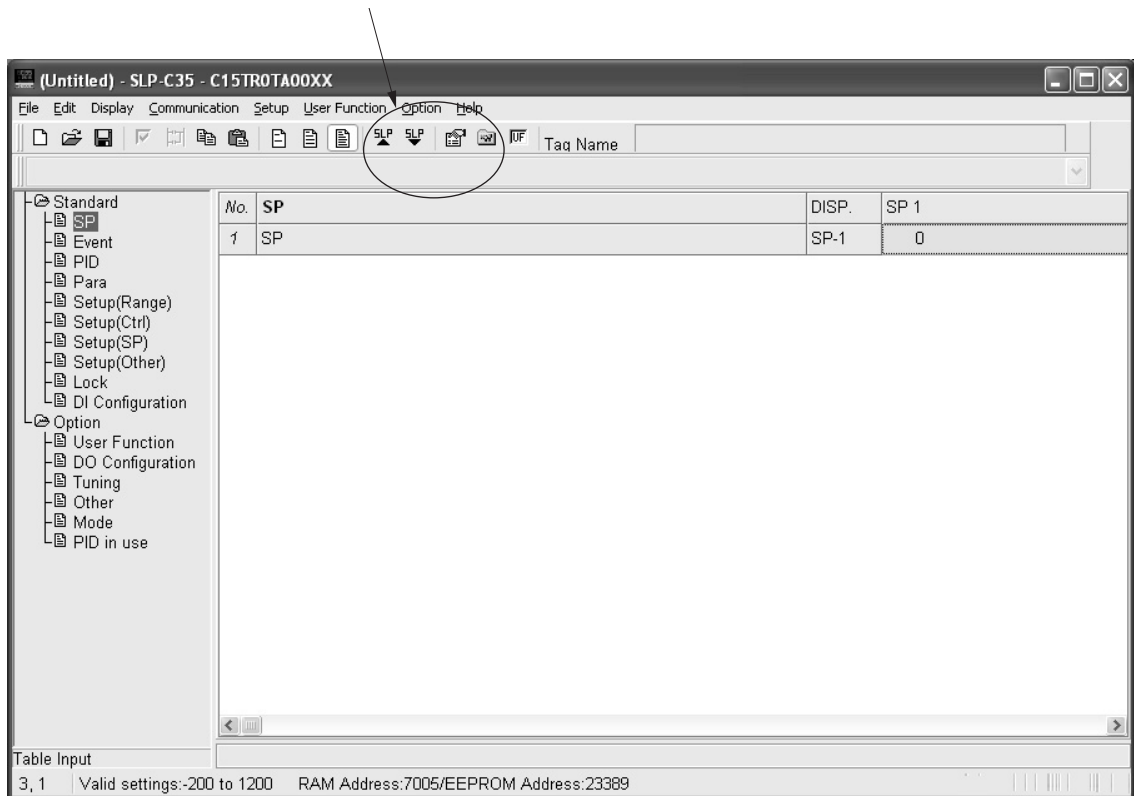

● Example 1 Logical OR of the heater burnout and PV high limit alarm is output.

Conditions: PV high limit is set to Internal Event 1.

Heater burnout is set to Internal Event 2.

Logical OR of the above events is output to the EV1 relay.

- (1) Select [Standard] → [Event] and set [Internal Event 1] to [1: PV high limit].
- (2) Similarly, set [Internal Event 2] to [16: Heater 1 break/Heater over current].
- (3) Select [Option] → [DO Assignment] and right-click on the operation type of [Event output 1] to select [Input/Output port setup].

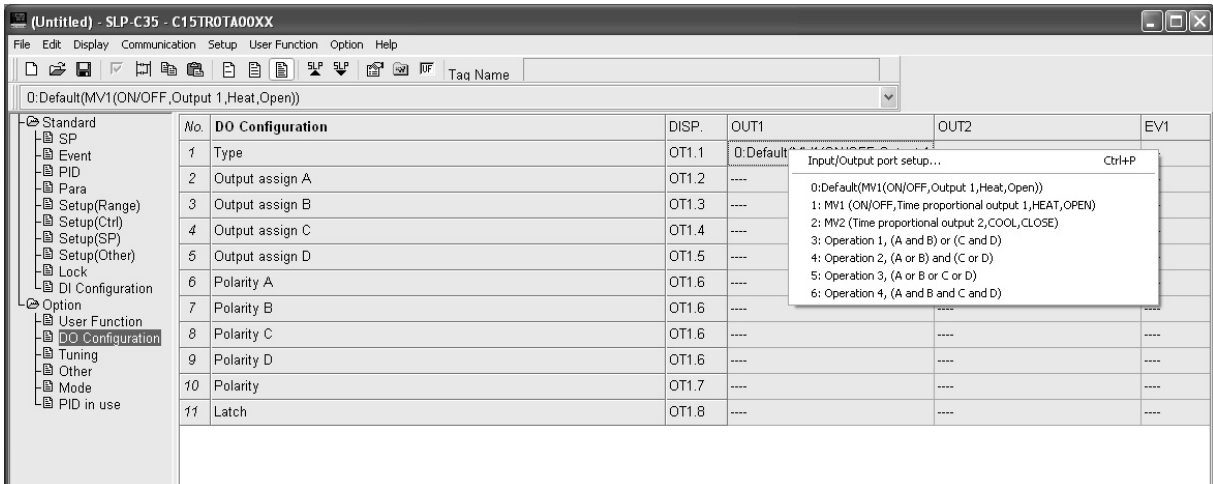

- (4) In the Input/Output port setup window, set the following items:
- (a) In this example, since the logical OR of two functions needs to be output, select [Function 1].
 - (b) Select [PV high limit] of Internal Event 1 for output assign A.
 - (c) Similarly, select [Heater break] of Internal Event 2 for output assign C.
 - (d) Select [Normally closed] for output assign B and D.

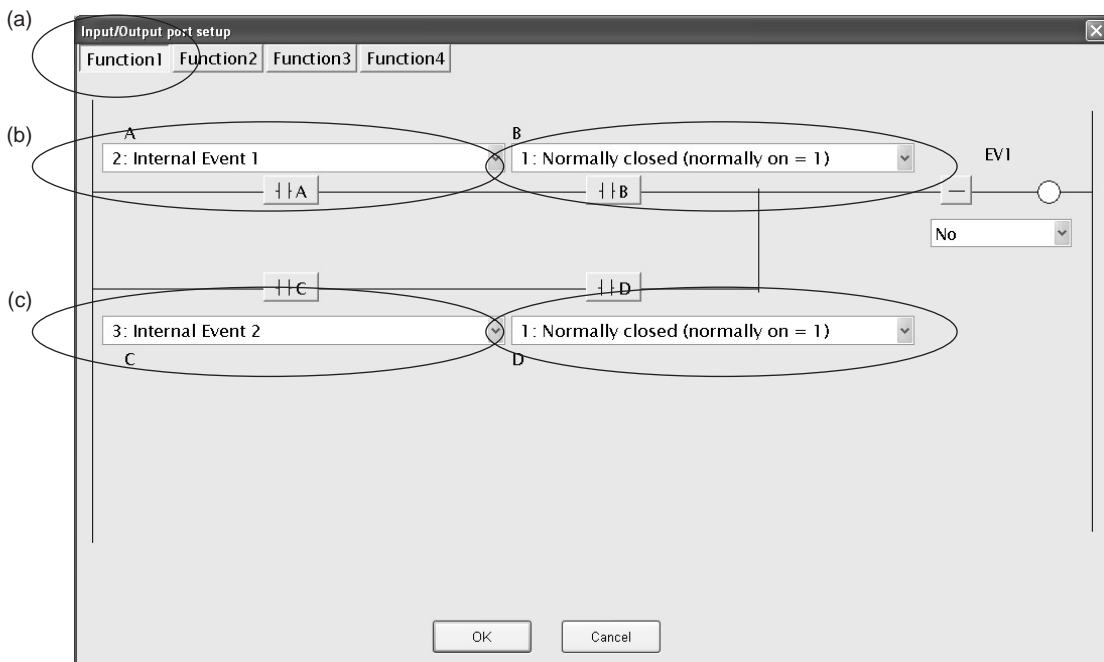

- **Example 2** The operation is started by the external switch, and then it is stopped automatically 30 min. after the temperature has reached the set value.

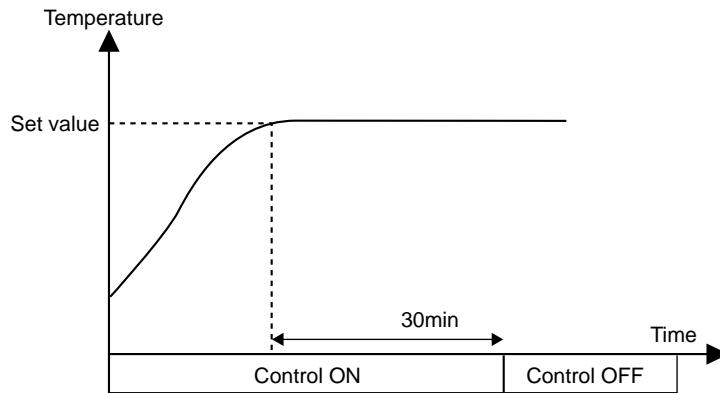

◆ **Explanation**

The timer start-up conditions are set to logical AND of DI1 and PV status EVs. The ON delay time setting of the timer becomes the time, at which the operation is stopped automatically after the temperature has reached the set value. The mode (RUN/READY) is changed based on a combination of DI1 and timer ON-OFF.

Status	Control OFF status	Timer counting after starting of operation	Operation stop by time-up
DI1	OFF	ON	ON
Timer (Internal EV2)	OFF	OFF	ON
Status of Internal Contact 2	ON	OFF	ON
Mode	READY	RUN	READY

◆ **Setting example**

• Event

Event	Display	Internal Event 1	Internal Event 2
Operation type	Ex.C1	32: Timer	4: Deviation high limit
Direct/reverse	Ex.C2	----	0: Direct
Standby	Ex.C2	----	0: No standby
EVENT state at READY	Ex.C2	0: EVENT state at READY is continued.	0: EVENT state at READY is continued.
Alarm OR	Ex.C3	0: None	0: None
Special OFF setup	Ex.C3	----	0: As usual.
Delay time unit	Ex.C3	2.1min	0: 0.1s
Event main setting (low limit)	Ex	----	0
Event sub setting (high limit)	Ex.SB	----	----
Hysteresis	Ex.HY	----	5
ON delay	Ex.ON	30	0
OFF delay	Ex.OF	0	0

Note. The internal event No. is indicated at the mark of "x" shown in the Display column.

• DI Assignment

DI Assignment	Display	Internal Contact 1	Internal Contact 2
Operation type	Dlx.1	17: Timer stop/start	7: RUN/READY
Input bit function	Dlx.2	1: Function 1 (A and B) or (C and D)	1: Function 1 (A and B) or (C and D)
Input assign A	Dlx.3	2: DI1	2: DI1
Input assign B	Dlx.4	11: Internal Event 2 (Setting = 4: Deviation high limit)	10: Internal Event 1 (Setting = 32: Timer (Status))
Input assign C	Dlx.5	0: Normally opened. (Normally Off = 0)	0: Normally opened. (Normally Off = 0)
Input assign D	Dlx.6	0: Normally opened. (Normally Off = 0)	0: Normally opened. (Normally Off = 0)
Polarity A	Dlx.7	0: Direct	0: Direct
Polarity B	Dlx.7	0: Direct	1: Reverse
Polarity C	Dlx.7	0: Direct	0: Direct
Polarity D	Dlx.7	0: Direct	0: Direct
Polarity	Dlx.8	0: Direct	1: Reverse
Event channel def.	Dlx.9	1	----

Note. The internal DI No. is indicated at the mark of "x" shown in the Display column.

◆ Setting points

The timer startup conditions are set to logical AND of DI1 and temperature attainment (Internal Event 2: Deviation high limit).

The mode (RUN/READY) selection is used as conditions for logical AND of the A contact of DI1 and the B contact of the timer. However, since the mode is the READY mode when the contact is ON, it is reversed in the final stage of internal contact 2.

DI Assignment (Internal Contact 1): Input/Output port setup

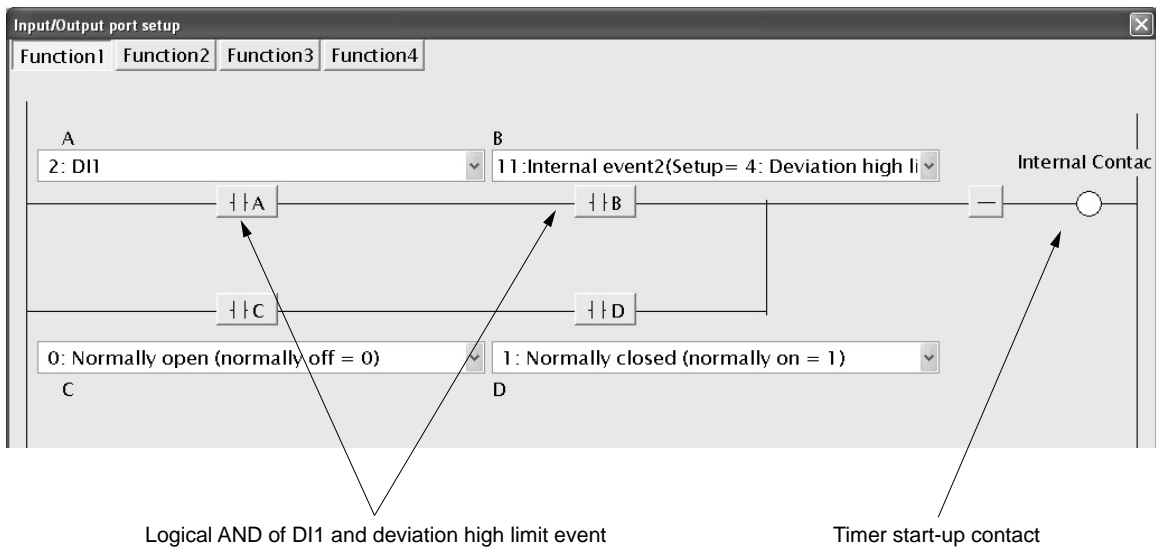

DI Assignment (Internal Contact 2): Input/Output port setup

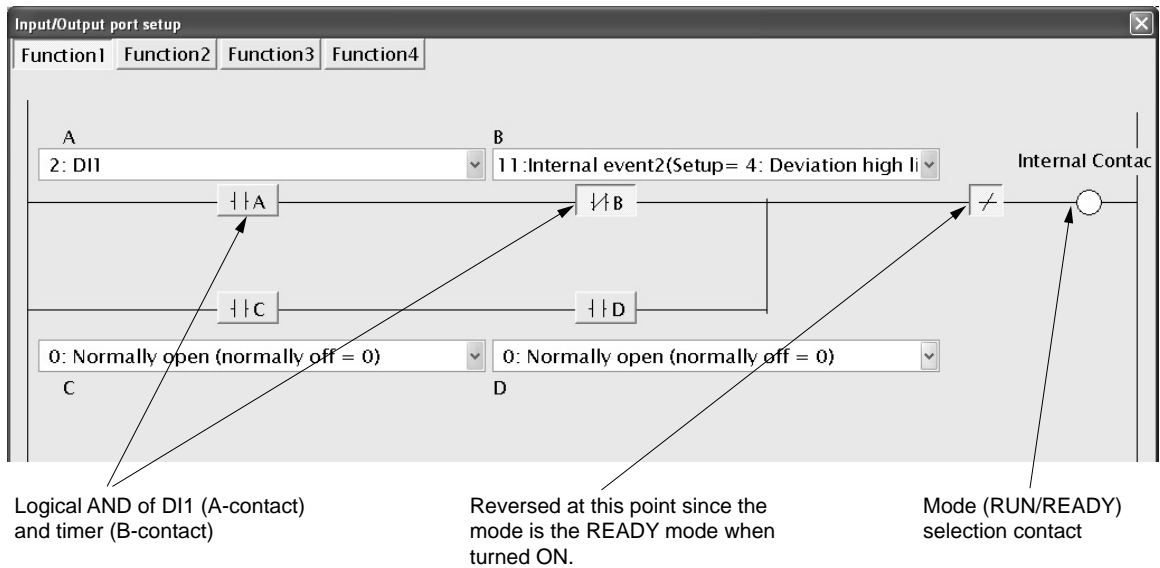

● Example 3 Simple pattern

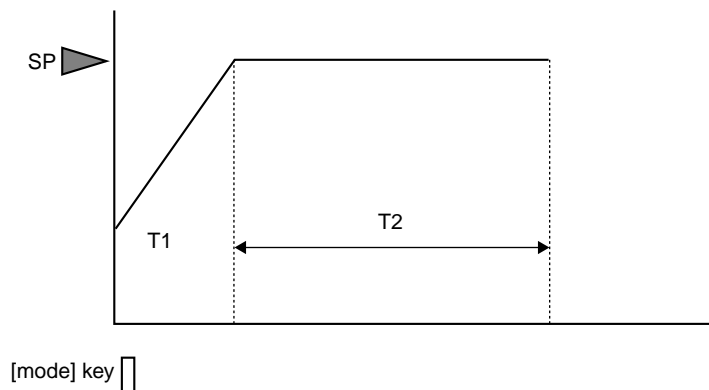

◆ Explanation

When the [mode] key is pressed, the mode is changed to the RUN mode and the PV is started.

The SP value moves up (or down) along with the up/down ramp set value.

When the SP value reaches the final SP value and the PV value enters the constant range, the counting is started. After the T2 time has elapsed, the mode is changed to the READY mode.

◆ Setting example

• Event

Event	Display	Internal Event 1	Internal Event 2
Operation type	Ex.C1	9: Deviation high/low limit (Final SP reference)	32: Timer (Status)
Direct/reverse	Ex.C2	1: Reversed.	----
Standby	Ex.C2	0: No standby	----
EVENT state at READY	Ex.C2	1: EVENT state at READY is forcibly turned OFF.	0: EVENT state at READY is continued.
Alarm OR	Ex.C3	0: None	0: None
Special OFF setup	Ex.C3	0: As usual.	----
Delay time unit	Ex.C3	0: 0.1s	0: 0.1s
Event main setting (low limit)	Ex	3	----
Event sub setting (high limit)	Ex.SB	3	----
Hysteresis	Ex.HY	9999	----
ON delay	Ex.ON	2	15
OFF delay	Ex.OF	0	0

Note. The internal event No. is indicated at the mark of "x" shown in the Display column.

• DI Assignment

DI Assignment	Display	Internal Contact 1	Internal Contact 2
Operation type	Dlx.1	7: RUN/READY	17: Timer stop/start
Input bit function	Dlx.2	1: Function 1 (A and B) or (C and D)	1: Function 1 (A and B) or (C and D)
Input assign A	Dlx.3	18: COM DI 1	10: Internal Event 1 (Setting = 9: Deviation high/low limit (Final SP reference))
Input assign B	Dlx.4	11: Internal Event 2 (Setting = 32: Timer (Status))	26: During SP ramp
Input assign C	Dlx.5	0: Normally opened. (Normally Off = 0)	18: COM DI 1
Input assign D	Dlx.6	0: Normally opened. (Normally Off = 0)	11: Internal Event 2 (Setting = 32: Timer (Status))
Polarity A	Dlx.7	0: Direct	0: Direct
Polarity B	Dlx.7	1: Reverse	1: Reverse
Polarity C	Dlx.7	0: Direct	0: Direct
Polarity D	Dlx.7	0: Direct	0: Direct
Polarity	Dlx.8	1: Reverse	0: Direct
Event channel def.	Dlx.9	----	2

Note. The internal DI No. is indicated at the mark of "x" shown in the Display column.

◆ Others

C72 [mode key function]: 7 (COM DI1 selection)
 SP up ramp/down ramp: Desired value

◆ Setting points

The internal EV1 is substituted for the guarantee soak.
 Therefore, “9999” is set to the hysteresis of Event 1 so that Event 1 is not turned OFF after it has been turned ON even though the PV fluctuates.

DI Assignment (Internal Contact 1): Input/Output port setup

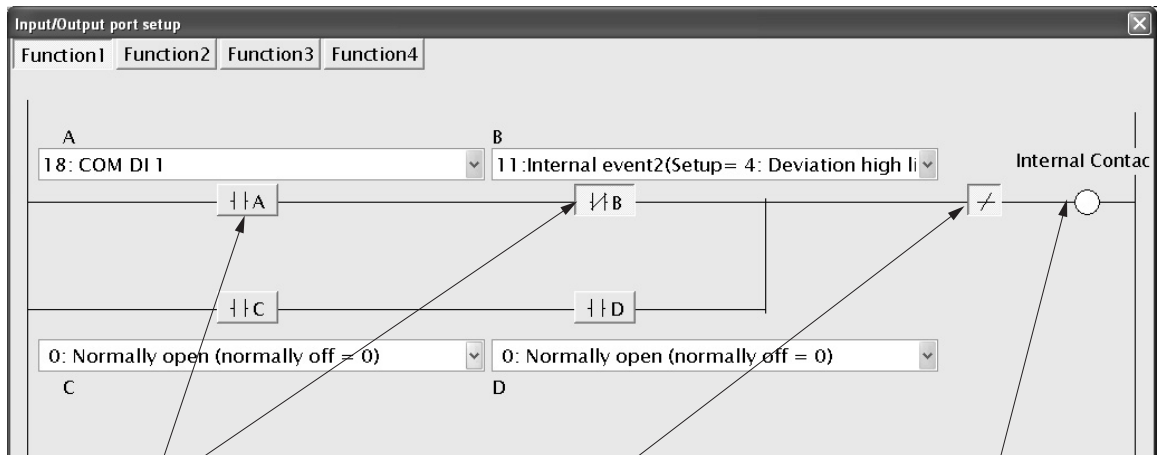

Logical AND of COM DI1 (a-contact) and timer (b-contact)

Reversed at this point since the mode is the READY mode when turned ON.

Mode (RUN/READY) selection contact

Conditions for guarantee soak (ramp is completed and operation enters within the deviation of the final SP.)

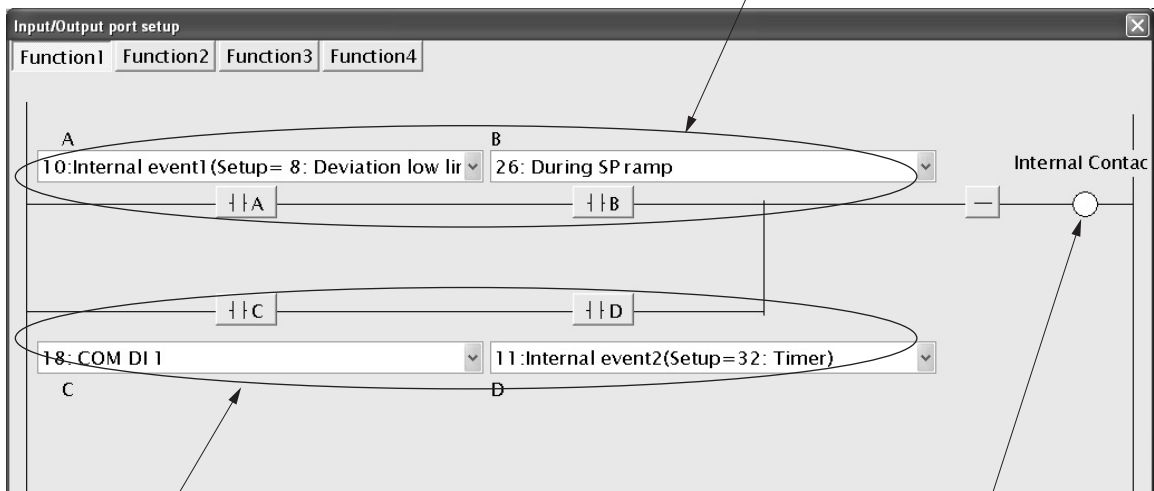

The timer start is self-retained at time-up so that the timer is not restarted due to change in PV.

Timer start-up contact

DI Assignment (Internal Contact 2): Input/Output port setup

5 - 12 Continuous Output

The following shows the functional block diagram of the continuous output:

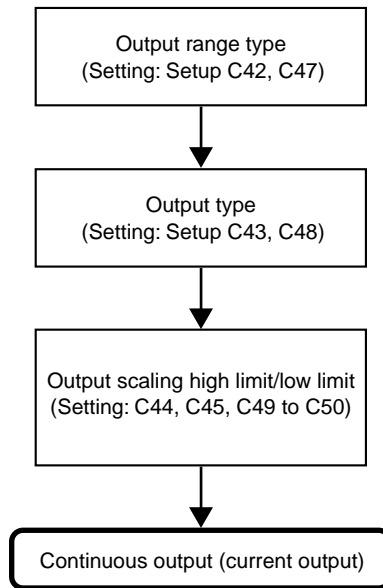

■ Output range

The output range of the current output can be set.

Item (Setting display/bank)	Display	Contents	Initial value	User level
Control output 1 range (Setup setting/Setup bank)	[42	1: 4 to 20mA 2: 0 to 20mA	1	Simple, Standard, High function
Control output 2 range (Setup setting/Setup bank)	[47		1	

- When the object control output is the current output, the display and setting can be made.

■ Output type

The output type of the current output can be set.

Item (Setting display/bank)	Display	Contents	Initial value	User level
Control output 1 type (Setup setting/Setup bank)	[43	0: MV (manipulated variable) 1: Heat MV (for heat/cool control) 2: Cool MV (for heat/cool control) 3: PV 4: PV before ratio, bias, and filter 5: SP 6: Deviation 7: CT1 current value 8: CT2 current value 9: MFB (Invalid on SDC15)	0	Simple, Standard, High function
Control output 2 type (Setup setting/Setup bank)	[48		3	

- When the object control output is the current output, the display and setting can be made.

■ **Output scaling low limit/high limit**

The output scaling low limit and high limit of the current output can be set.

Item (Setting display/bank)	Display	Contents	Initial value	User level
Control output 1 scaling low limit (Setup setting/Setup bank)	⌈ 44	-1999 to +9999 The decimal point position may vary so that it meets the output type.	0.0	Simple, Standard, High function
Control output 1 scaling high limit (Setup setting/Setup bank)	⌈ 45		100.0	
Control output 2 scaling low limit (Setup setting/Setup bank)	⌈ 49		0	
Control output 2 scaling high limit (Setup setting/Setup bank)	⌈ 50		1000	

- When the object control output is the current output, the display and setting can be made.
- The following Figures show the relationship between the numeric value and output of the output type using the output scaling low limit/high limit settings:

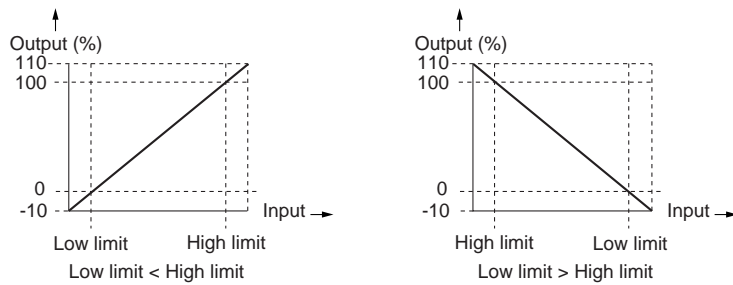

However, the output is 0 to 110% in a range of 0 to 20mA.

5 - 13 CT (Current Transformer) Input

For CT input, two kinds of current values are provided.

- Current value at output ON.: This current value is used for the heater burnout/over-current event. This current value is displayed as CT current value.
- Current value at output OFF.: This current value is used for the heater short-circuit event. This current value cannot be displayed.

When [CT type] is set at “heater burnout detection” (C36 = 0 or C39 = 0), the following operation is performed: The current value at output ON becomes the CT current value measured when the output specified in [CT output] is turned ON.

The current value at output OFF becomes the CT current value measured when the output specified in [CT output] is turned OFF.

When [CT type] is set at “current value measurement” (C36 = 1 or C39 = 1), the following operation is performed: The current value at output ON becomes the measured CT current value regardless of the output ON/OFF status. The current value at output OFF is fixed at “0.0A”.

The following shows the functional block diagram of the CT (current transformer) input:

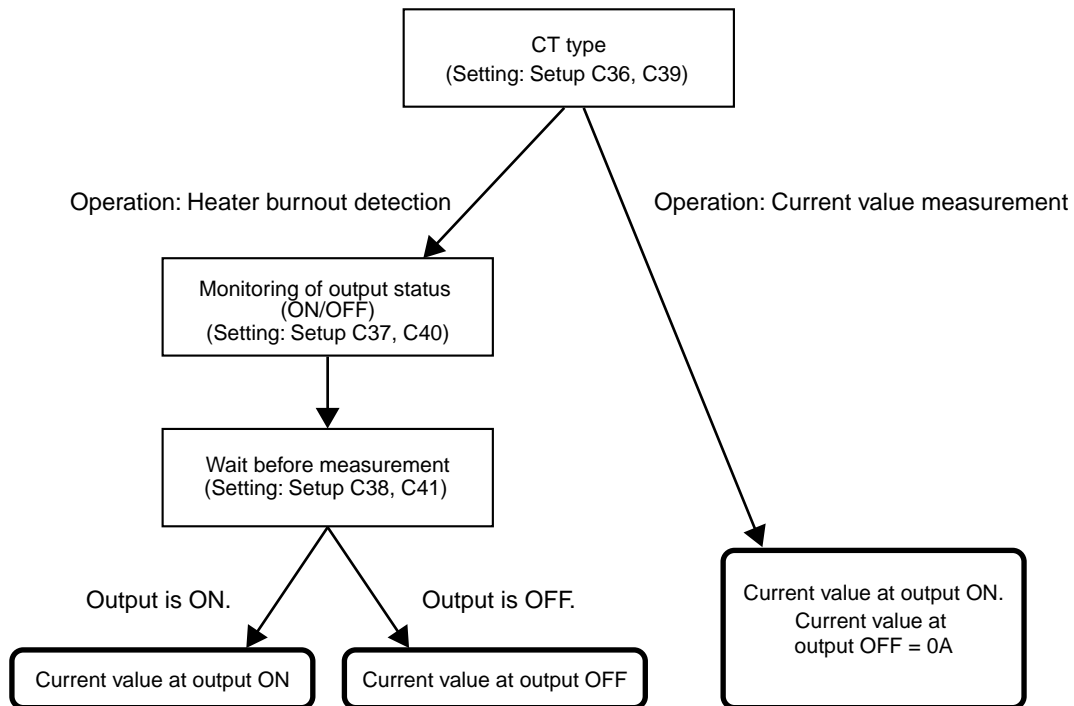

! Handling Precautions

The current value at output ON is used when the operation type of the Internal Event is set at [heater burnout/over-current].

The current value at output OFF is used when the operation type of the Internal Event is set at [heater short-circuit].

■ CT type

A desired operation type can be set for each of CT input 1 or CT input 2.

Item (Setting display/bank)	Display	Contents	Initial value	User level
CT1 operation type (Setup setting/Setup bank)	36	0: Heater burnout detection 1: Current value measurement	0	Simple, Standard, High function
CT2 operation type (Setup setting/Setup bank)	39		0	

- When the optional model has two CT input points, the display and setting can be made.
- When the CT type is set at “current value measurement”, the current value at output ON is updated regardless of the output ON/OFF status and the current value at output OFF is fixed at “0.0A”.

■ CT output

When the CT type is set at “heater burnout detection”, the output of the output ON/OFF monitor object can be set.

Item (Setting display/bank)	Display	Contents	Initial value	User level
CT1 output (Setup setting/Setup bank)	37	0: Control output 1 1: Control output 2 2: Event output 1	0	Simple, Standard, High function
CT2 output (Setup setting/Setup bank)	40	3: Event output 2 4: Event output 3	0	

- When the optional model has two CT input points and the CT type is set at “heater burnout detection”, the display and setting can be made.

■ CT measurement wait time

When the CT type is set at “heater burnout detection”, a period of time between changing of the output ON/OFF and starting of the current value measurement can be set.

Item (Setting display/bank)	Display	Contents	Initial value	User level
CT1 measurement wait time (Setup setting/Setup bank)	38	20 to 300 ms	30ms	Simple, Standard, High function
CT2 measurement wait time (Setup setting/Setup bank)	41		30ms	

- When the optional model has two CT input points and the CT type is set at “heater burnout detection”, the display and setting can be made.
- When the measurement wait time has elapsed after the ON/OFF status of the output to be monitored has been changed, the measurement of the current value is started. When 100 ms have elapsed after that, the measurement of the current value is completed.

5 - 14 Console Display and Key Operation

It is possible to make the setting so that the console display and key operation are customized.

■ Key operation type

Two kinds of general key operation flows are provided, standard key operation type and special key operation type. A desired key operation type can be selected. (For details about two kinds of key operation types,  refer to 2-2, Key Operation (on page 2-2).)

Item (Setting display/bank)	Display	Contents	Initial value	User level
Key operation type (Setup setting/Setup bank)	 71	0: Standard type 1: Special type	0	High function

■ [mode] key function

The selection operation when the [mode] key is kept pressed for 1 sec. or longer in the operation display mode can be set.

Item (Setting display/bank)	Display	Contents	Initial value	User level
[mode] key function (Setup setting/Setup bank)	 72	0: Invalid 1: AUTO/MANUAL selection 2: RUN/READY selection 3: AT Stop/Start 4: LSP group selection 5: Release all DO latches 6: Invalid 7: Communication DI1 selection 8: Invalid	0	Simple, Standard, High function

Handling Precautions

- When [Ctrl: Control method] is set at “0” (ON/OFF control), the AUTO/MANUAL selection becomes invalid.
- When [Ctrl: Control method] is set at “0” (ON/OFF control) or if the PV high limit/low limit alarm occurs, the AT stop/start selection becomes invalid.
- When [C30: LSP system group] is set at “1”, the LSP group selection becomes invalid.

■ MODE display setup

Whether or not the mode related setup items of the parameter setting and mode bank are displayed can be set.

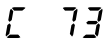
Item (Setting display/bank)	Display	Contents	Initial value	User level
MODE display setup (Setup setting/Setup bank)		Whether or not the mode bank setup is displayed is determined by the sum of the following weights: Bit 0: AUTO/MANUAL display Disabled: 0, Enabled: +1 Bit 1: RUN/READY display Disabled: 0, Enabled: +2 Bit 3: AT stop/start display Disabled: 0, Enabled: +8 Bit 4: Release all DO latches display Disabled: 0, Enabled: +16 Bit 5: Communication DI1 ON/OFF display Disabled: 0, Enabled: +32 Other invalid settings, 0, +4, +64, +128	255	Standard, High function

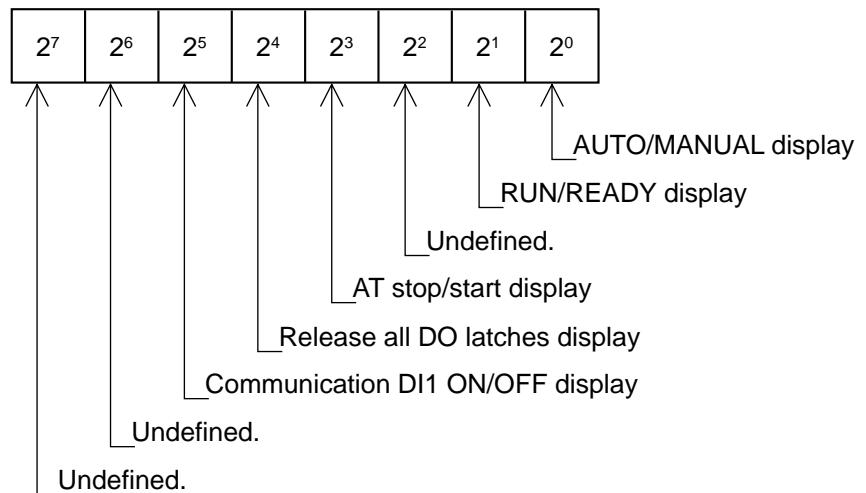

- When using the Smart Loader Package SLP-C35, not only the numeric value, but also the bit input can be used to set [MODE display setup: C73].

⚠ Handling Precautions

- Even though the AUTO/MANUAL display is set at [Displayed], the AUTO/MANUAL is not displayed when [Ctrl: Control method] is set at "0" (ON/OFF control).
- Even though the AT stop/start display is set at [Displayed], the AT stop/start is not displayed when [Ctrl: Control method] is set at "0" (ON/OFF control).

■ PV/SP display setup

Whether or not the PV/SV value related items are displayed in the operation display mode can be set.

Item (Setting display/bank)	Display	Contents	Initial value	User level
PV/SP display setup (Setup setting/Setup bank)		Whether or not the PV/SP value related items are displayed in the operation display mode is determined by the sum of the following weights: Bit 0: PV display Disabled: 0, Enabled: +1 Bit 1: SP display Disabled: 0, Enabled: +2 Bit 2: LSP group number display Disabled: 0, Enabled: +4 Other invalid settings, 0, +8	15	Standard, High function

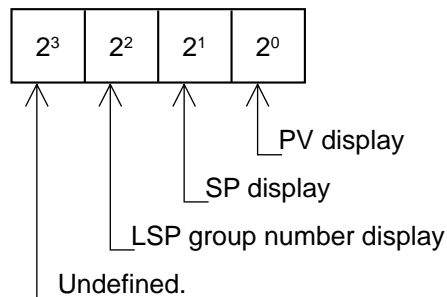

- When using the Smart Loader Package SLP-C35, not only the numeric value, but also the bit input can be used to set [PV/SP display setup: C74].

⚠ Handling Precautions

- Even though the LSP group number display is set at [Enabled], the LSP group number is not displayed when [C30: LSP system group] is set at “1”.

■ MV display setup

Whether or not the MV related items are displayed in the operation display mode can be set.

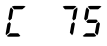
Item (Setting display/bank)	Display	Contents	Initial value	User level
MV display setup (Setup setting/Setup bank)		Whether or not the MV value related items are displayed in the operation display mode is determined by the sum of the following weights: Bit 0: MV display Disabled: 0, Enabled: +1 Bit 1: Heat MV/cool MV display Disabled: 0, Enabled: +2 Bit 3: AT progress display Disabled: 0, Enabled: +8 Other invalid settings, 0, +4	15	Standard, High function

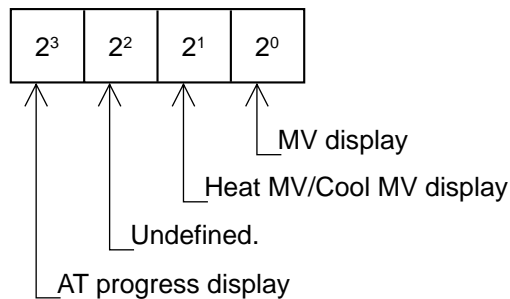

- When using the Smart Loader Package SLP-C35, not only the numeric value, but also the bit input can be used to set [MV display setup: C75].

⚠ Handling Precautions

- Even though the heat MV/cool MV display is set at [Enabled], the heat MV/cool MV is not displayed when [Heat/Cool control: C26] is set at "0" (Disabled).
- Even though the AT progress display is set at [Enabled], the AT progress is not displayed while the AT is stopping.

■ EV display setup

Whether or not the main setting and sub setting of Internal Events 1 to 3 are displayed in the operation display mode can be set.

Item (Setting display/bank)	Display	Contents	Initial value	User level
EV display setup (Setup setting/Setup bank)	 76	0: Internal Event set value is not displayed in the operation display mode. 1: Set value of Internal Event 1 is displayed in the operation display mode. 2: Set values of Internal Events 1 to 2 are displayed in the operation display mode. 3: Set values of Internal Events 1 to 3 are displayed in the operation display mode.	0	Standard, High function

! Handling Precautions

- Even though the Internal Event set value is set at [Enabled], the Internal Event set values are not displayed when the main setting and sub setting are not necessary according to the operation type of Internal Event.
- The main setting and sub setting of Internal Events 4 to 5 cannot be displayed in the operation display mode.

■ Timer remain time display setup

Whether or not the ON delay/OFF delay remain time of Internal Events 1 to 3 is displayed in the operation display mode can be set.

Item (Setting display/bank)	Display	Contents	Initial value	User level
Timer remain time display setup (Setup setting/Setup bank)	 77	0: ON/OFF delay remain time of Internal Event is not displayed in the operation display mode. 1: ON/OFF delay remain time of Internal Event 1 is displayed in the operation display mode. 2: ON/OFF delay remain time of Internal Events 1 to 2 is displayed in the operation display mode. 3: ON/OFF delay remain time of Internal Events 1 to 3 is displayed in the operation display mode.	0	Standard, High function

! Handling Precautions

- Even though the Internal Event timer remain time is set at [Enabled], the timer remain time is not displayed when the timer remain time display is not necessary according to the operation type of Internal Event.
- The timer remain time of Internal Events 4 to 5 cannot be displayed in the operation display mode.

■ CT display setup

Whether or not the CT current value is displayed in the operation display mode can be set.

Item (Setting display/bank)	Display	Contents	Initial value	User level
CT display setup (Setup setting/Setup bank)		0: CT current value is not displayed in the operation display mode. 1: CT1 current value is displayed in the operation display mode. 2: CT1 to 2 current values are displayed in the operation display mode.	1	Standard, High function

- When the optional model has two CT input points, the display and setting can be made.

■ User level

The user level of the console display can be set.

As a larger value is set, the number of possible displays/settings is increased.

Item (Setting display/bank)	Display	Contents	Initial value	User level
User level (Setup setting/Setup bank)		0: Simple configuration 1: Standard configuration 2: High function configuration	0	Simple, Standard, High function

■ Communication monitor display

The function of the decimal point LED at the right end digit of the lower display (lower 4-digit display) can be set.

Item (Setting display/bank)	Display	Contents	Initial value	User level
Communication monitor display (Setup setting/Setup bank)		0: Disabled 1: Flashing while data is sending through RS-485 communication. 2: Flashing while data is receiving through RS-485 communication. 3: Logical OR of all DI statuses 4: Flashing in READY mode	0	High function

■ User Function

Up to eight settings selected from various settings can be added to the operation display.

Item (Setting display/bank)	Display	Contents	Initial value	User level
User Function 1 (Setup setting/User Function bank)	UF-1	Each setting is set on the upper display. The following shows the setting exceptions: ----: Not registered. P-: P (Proportional band) of currently used PID group I-: I (Integral time) of currently used PID group D-: D (Derivative time) of currently used PID group rE-: Manual reset of currently used PID group oL: Output low limit of currently used PID group oH: Output high limit of currently used PID group It is possible to register only the settings, which can be displayed. (Example: Manual reset of the PID constant can be registered when the I (Integral time) is set at "0".)	----	Standard, High function
User Function 2 (Setup setting/User Function bank)	UF-2		----	
User Function 3 (Setup setting/User Function bank)	UF-3		----	
User Function 4 (Setup setting/User Function bank)	UF-4		----	
User Function 5 (Setup setting/User Function bank)	UF-5		----	
User Function 6 (Setup setting/User Function bank)	UF-6		----	
User Function 7 (Setup setting/User Function bank)	UF-7		----	
User Function 8 (Setup setting/User Function bank)	UF-8		----	

- When using the Smart Loader Package SLP-C35, [User Function] can be registered even though the conditions for instrument status are set as display disabled.

ⓘ Handling Precautions

The settings registered in the User Function are not displayed in the operation display mode when the display is set disabled.

● User Function setting procedures

This section describes an example of setting with the Smart Loader Package SLP-C35.

When registering the user function, up to eight parameters can be registered to the [para] key.

When frequently used functions are registered, this ensures convenient operation. In this example, the main setting of event 1 is registered into UF1.

1. To register a user function from the user function item:

When using this function, first set the user level to “Standard configuration” or “High function configuration”.

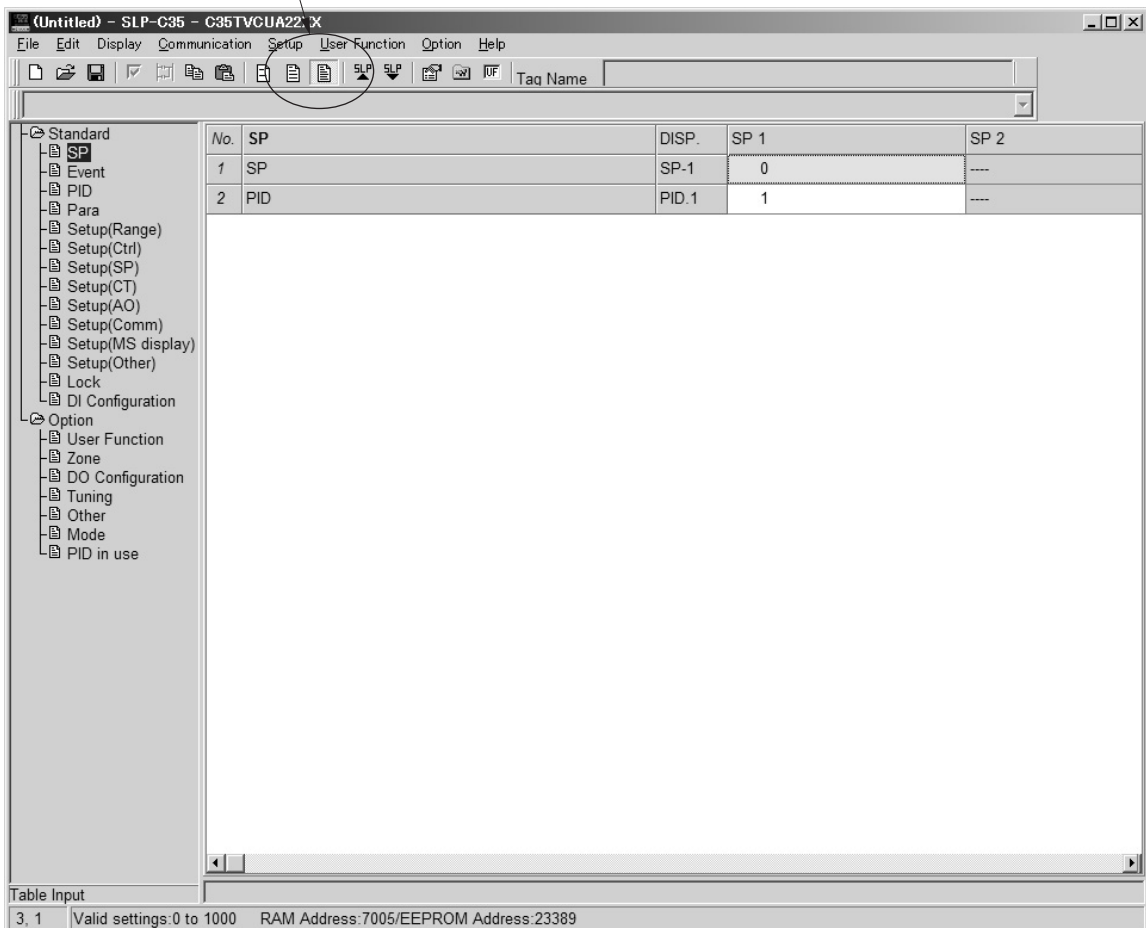

- (1) Select [Option] → [User Function].
- (2) Select [1: Event] in [Group select].
- (3) Select [801: Event value] in [Item select].

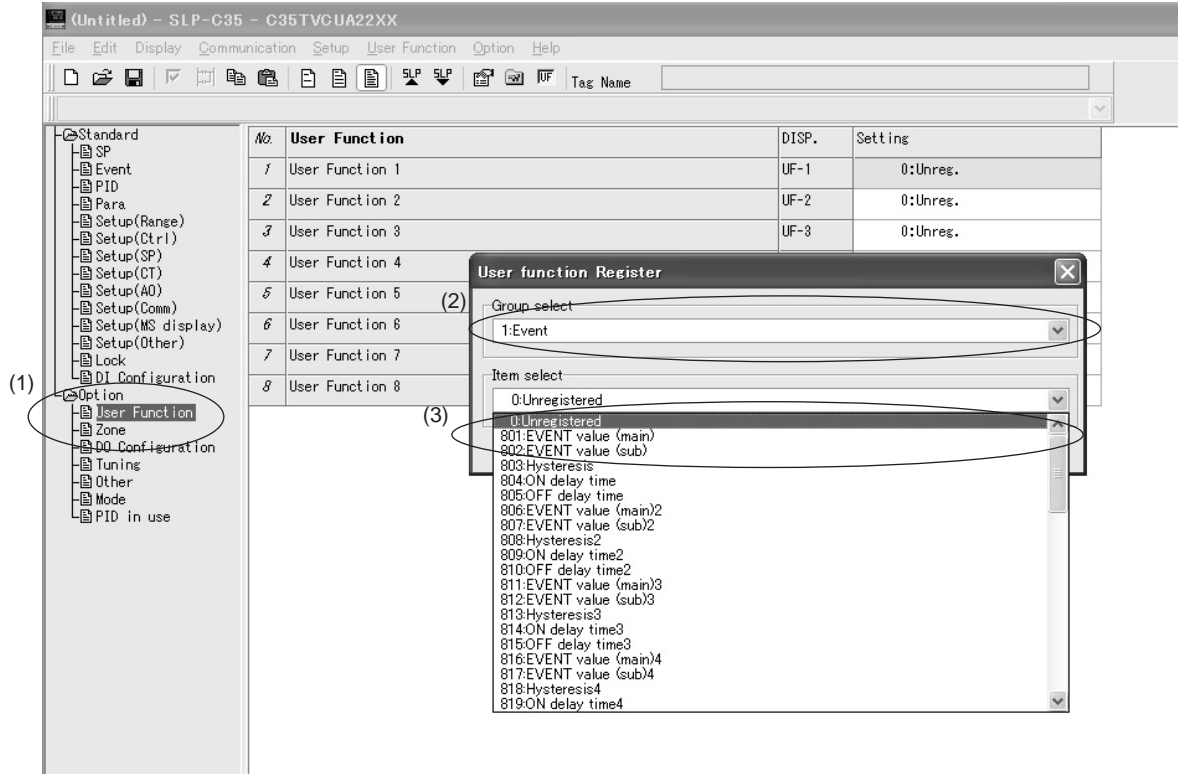

2. To register currently setting item into the user function:

If there are any parameters you wish to register into the user function during setting, follow the steps below to register such parameters.

(1) Keep the cursor placed in an item you wish to register and set, and then left-click the [UF] icon.

>> The user function register box will appear.

(2) Check on Nos. you wish to register and click [Register].

>> Items you have checked on are then registered.

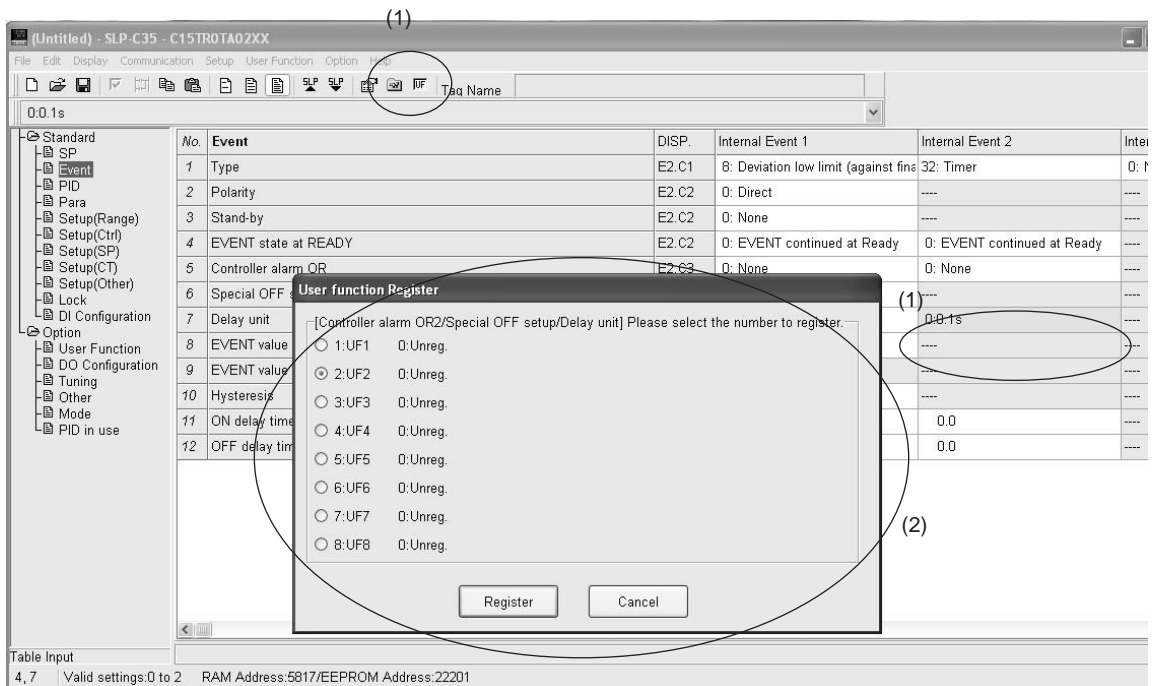

Note

The registered contents can also be checked by selecting [Option] → [User Function].

■ **Key lock, communication lock, and loader lock**

The setting (changing) or display can be set disabled using the key lock.

Item (Setting display/bank)	Display	Contents	Initial value	User level
Key lock (Setup setting/Lock bank)	<i>L o L</i>	0: All settings are possible. 1: Mode, event, operation display, SP, UF, lock, manual MV, and mode key can be set. 2: Operation display, SP, UF, lock, manual MV, and mode key can be set. 3: UF, lock, manual MV, and mode key can be set.	0	Simple, Standard, High function
Communication lock (Setup setting/Lock bank)	<i>[L o L]</i>	0: RS-485 communication read/write enabled. 1: RS-485 communication read/write disabled.	0	High function
Loader lock (Setup setting/Lock bank)	<i>LL o L</i>	0: Loader communication read/write enabled. 1: Loader communication read/write disabled.	0	High function

The communication can be set disabled using the communication lock and loader lock.

- When using only the key lock setting, key lock objects can be displayed, but the setting (changing) cannot be made.
- When locked with the password, the display and setting of key lock objects cannot be made.

■ Password

The setting (changing) of the key lock, communication lock, and loader lock can be set disabled using the password.

Item (Setting display/bank)	Display	Contents	Initial value	User level
Password display (Setup setting/Lock bank)	PASS	0 to 15 5: Password 1A to 2B display	0 (The initial value becomes "0" when the power is turned ON.)	Simple, Standard, High function
Password 1A (Setup setting/Lock bank)	PS 1A	0000 to FFFF (Hexadecimal value)	0000	Simple, Standard, High function
Password 2A (Setup setting/Lock bank)	PS 2A	0000 to FFFF (Hexadecimal value)	0000	
Password 1B (Setup setting/Lock bank)	PS 1b	0000 to FFFF (Hexadecimal value)	0000	
Password 2B (Setup setting/Lock bank)	PS 2b	0000 to FFFF (Hexadecimal value)	0000	

- When using only the key lock setting, the display can be made, but the setting (changing) cannot be made.
- When locked with the password, the display and setting cannot be made.
- The display and setting of [Password 1A: PS1A] and [Password 2A: PS2A] can be made only when [Password display: PASS] is "5" and the passwords of two groups (1A and 1B, 2A and 2B) are matched.
- The display and setting of [Password1B: PS1b] and [Password 2B: PS2b] can be made only when [Password display: PASS] is "5".
- The value set in [Password1A: PS1A] is automatically set to [Password1B: PS1b].
- The value set in [Password2A: PS2A] is automatically set to [Password2B: PS2b].

! Handling Precautions

- Before setting the passwords 1A to 2B, determine two hexadecimal values to be used as passwords and take a memorandum of these passwords to record them.
- [PASS] is used to prevent incorrect password setting by limiting the display conditions of passwords 1A to 2B.
- When other values are set for passwords 1B and 2B after the values to be used as passwords have been set for passwords 1A and 2A, the passwords 1A and 2A cannot be displayed and the key lock, communication lock and loader lock cannot be changed. This status is called "password lock status".
- The settings, which cannot be changed by the key lock, cannot be displayed in the password lock mode.
- If the password lock cannot be unlocked, contact Yamatake or its dealer. By returning the setting to the initial setting at Yamatake's factory, the password lock can be unlocked. In this case, note that the data, which has been set by the customer, cannot be saved (retained).

Chapter 6. LIST OF DISPLAYS AND SETTING DATA

6 - 1 List of Operation Displays

The following shows the meanings of the values stated in the “User Level” column:

0: Simple, Standard, or High function configuration, 1: Standard or High function configuration, and 2: High function configuration

■ Operation displays

Display	Item	Contents	Initial value	User level	Remarks
Upper display: PV Lower display: SP	SP (Target value)	SP low limit (C07) to SP high limit (C08)	0	0	Whether or not this item is displayed is selected by the PV/SP display setup (C74).
<i>LSP 1</i> (Display example) Lower display: LSP	LSP group number (Numeric value at 1st digit = the right end digit)	1 to LSP system group (C30, Max. 4)	1	0	Displayed when LSP system group (C30) is “2” or more. The lower display shows the LSP set value corresponding to the LSP group number. Whether or not this item is displayed is selected by the PV/SP display setup (C74).
<i>OUT</i>	MV (Manipulated Variable)	-10.0 to +110.0% Setting is disabled in AUTO mode. (Numeric value does not flash.) Setting is enabled in MANUAL mode. (Numeric value flashes.)	—	0	In the ON/OFF control (Ctrl = 0), “100.0” is displayed at ON and “0.0” is displayed at OFF. Whether or not this item is displayed is selected by the MV display setup (C75).
<i>HEAT</i>	Heat MV (Manipulated Variable)	Setting is disabled.	—	0	This item is displayed when using the Heat/Cool control (C26 = 1).
<i>COOL</i>	Cool MV (Manipulated Variable)	Setting is disabled.	—	0	Whether or not this item is displayed is selected by the MV display setup (C75).
Upper display: PV <i>At 1</i> (Display example)	AT progress display (Numeric value at the 1st digit = right end digit)	Setting is disabled. 1 or more : During execution of AT (Value is decreased.) 0: Completion of AT	—	0	Displayed during execution of AT. (The display is continued even after completion of AT.) Whether or not this item is displayed is selected by the MV display setup (C75).
<i>CT 1</i>	CT (Current transformer) current value 1	Setting is disabled.	—	0	Displayed when the optional model has two current transformer points.
<i>CT 2</i>	CT (Current transformer) current value 2	Setting is disabled.	—	0	Whether or not this item is displayed is selected by the CT display setup (C78).
<i>E 1</i>	Internal Event 1 main setting	The allowable setting range may vary depending on the operation type of the internal event. -1999 to +9999U: Set value is other than the following values: 0 to 9999U: Set value is an absolute value. -199.9 to +999.9%: Set value is MV.	0	0	Setting required by the operation type of the internal event is displayed. Whether or not this item is displayed is selected by the EV display setup (C76).
<i>E 1sb</i>	Internal Event 1 sub setting		0	0	
<i>t 1. .</i> (Display example)	Timer remaining time 1	Setting is disabled. “Γ” is displayed at the right end digit when using the ON delay time. “L” is displayed at the right end digit when using the OFF delay time.	—	0	Whether or not this item is displayed is selected by the timer remain time display setup (C77).
<i>E 2</i>	Internal Event 2 main setting	The allowable setting range may vary depending on the operation type of the internal event. -1999 to +9999U: Set value is other than the following values: 0 to 9999U: Set value is an absolute value. -199.9 to +999.9%: Set value is MV.	0	0	Setting required by the operation type of the internal event is displayed. Whether or not this item is displayed is selected by the EV display setup (C76).
<i>E 2sb</i>	Internal Event 2 sub setting		0	0	
<i>t 2. . .</i> (Display example)	Timer remain time 2	Setting is disabled. “Γ” is displayed at the right end digit when using the ON delay time. “L” is displayed at the right end digit when using the OFF delay time.	—	0	Whether or not this item is displayed is selected by the timer remain time display setup (C77).

Chapter 6. LIST OF DISPLAYS AND SETTING DATA

Display	Item	Contents	Initial value	User level	Remarks
<i>E3</i>	Internal Event 3 main setting	The allowable setting range may vary depending on the operation type of the internal event. -1999 to +9999U: Set value is other than the following values. 0 to 9999U: Set value is an absolute value. -199.9 to +999.9%: Set value is MV.	0	0	Setting required by the operation type of the internal event is displayed. Whether or not this item is displayed is selected by the EV display setup (C76).
<i>E3.5b</i>	Internal Event 3 sub setting		0	0	
<i>E3..</i> (Display example)	Timer remain time 3	Setting is disabled. "Γ" is displayed at the right end digit when using the ON delay time. "L" is displayed at the right end digit when using the OFF delay time.	—	0	Whether or not this item is displayed is selected by the timer remain time display setup (C77).

6 - 2 List of Parameter Setting Displays

The following shows the meanings of the values stated in the "User Level" column:

0: Simple, Standard, or High function configuration, 1: Standard or High function configuration, and 2: High function configuration

■ Mode bank

Bank selection: *mode*

Display	Item	Contents	Initial value	User level	Remarks
<i>A - - n</i>	AUTO/MANUAL	AUto: AUTO mode MAn: MANUAL mode	AUTO	0	Displayed when the control method is other than the ON/OFF control (Ctrl≠0). Whether or not this item is displayed is selected by the display mode setup (C73).
<i>r - - r</i>	RUN/READY	rUn: RUN mode rdy: READY mode	RUN	0	Whether or not this item is displayed is selected by the display mode setup (C73).
<i>At</i>	AT stop/start	At.oF: AT stop At.on: AT start	AT stop	0	Displayed when the control method is other than the ON/OFF control (Ctrl≠0). Whether or not this item is displayed is selected by the display mode setup (C73).
<i>doLl</i>	Release all DO latches	Lt.on: Latch continue Lt.oF: Latch release	Latch continue	0	All DO latches such as control outputs (relay and voltage pulse) and event outputs can be released. Whether or not this item is displayed is selected by the display mode setup (C73).
<i>Cl 1</i>	Communication DI	dl.oF: OFF dl.on: ON	OFF	0	Whether or not this item is displayed is selected by the display mode setup (C73).

■ SP bank

Bank selection: *SP*

Display	Item	Contents	Initial value	User level	Remarks
<i>SP-1</i>	SP of LSP 1 group	SP low limit (C07) to SP high limit (C08)	0	0	
<i>SP-2</i>	SP of LSP 2 group		0	0	Displayed when LSP system group (C30) is "2" or more.
<i>SP-3</i>	SP of LSP 3 group		0	0	Displayed when LSP system group (C30) is "3" or more.
<i>SP-4</i>	SP of LSP 4 group		0	0	Displayed when LSP system group (C30) is "4" or more.

■ Event bank

Bank selection: *E_U*

Display	Item	Contents	Initial value	User level	Remarks
<i>E 1</i>	Internal Event 1 main setting	-1999 to +9999 The decimal point position may vary so that it meets the operation type of the internal event. The above value becomes 0 to 9999 in some operation types.	0	0	Necessary settings are displayed according to Internal Event 1 operation type (E1.C1).
<i>E 15b</i>	Internal Event 1 sub setting		0	0	
<i>E 1HY</i>	Internal Event 1 Hysteresis		0 to 9999 The decimal point position may vary so that it meets the operation type of the internal event.	5	
<i>E 1on</i>	Internal Event 1 ON delay time	0.0 to 999.9 (Delay unit is 0.1s.) 0 to 9999 (Delay unit is other than 0.1s.)	0	2	
<i>E 1oF</i>	Internal Event 1 OFF delay time		0	2	
<i>E 2</i>	Internal Event 2 main setting	Same as Internal Event 1.	0	0	Necessary settings are displayed according to Internal Event 2 operation type (E2.C1).
<i>E 25b</i>	Internal Event 2 sub setting		0	0	
<i>E 2HY</i>	Internal Event 2 Hysteresis		5	1	
<i>E 2on</i>	Internal Event 2 ON delay time		0	2	
<i>E 2oF</i>	Internal Event 2 OFF delay time		0	2	
<i>E 3</i>	Internal Event 3 main setting	Same as Internal Event 1.	0	0	Necessary settings are displayed according to Internal Event 3 operation type (E3.C1).
<i>E 35b</i>	Internal Event 3 sub setting		0	0	
<i>E 3HY</i>	Internal Event 3 Hysteresis		5	1	
<i>E 3on</i>	Internal Event 3 ON delay time		0	2	
<i>E 3oF</i>	Internal Event 3 OFF delay time		0	2	
<i>E 4</i>	Internal Event 4 main setting	Same as Internal Event 1.	0	0	Necessary settings are displayed according to Internal Event 4 operation type (E4.C1).
<i>E 45b</i>	Internal Event 4 sub setting		0	0	
<i>E 4HY</i>	Internal Event 4 Hysteresis		5	1	
<i>E 4on</i>	Internal Event 4 ON delay time		0	2	
<i>E 4oF</i>	Internal Event 4 OFF delay time		0	2	
<i>E 5</i>	Internal Event 5 main setting	Same as Internal Event 1.	0	0	Necessary settings are displayed according to Internal Event 5 operation type (E5.C1).
<i>E 55b</i>	Internal Event 5 sub setting		0	0	
<i>E 5HY</i>	Internal Event 5 Hysteresis		5	1	
<i>E 5on</i>	Internal Event 5 ON delay time		0	2	
<i>E 5oF</i>	Internal Event 5 OFF delay time		0	2	

■ PID bank

Bank selection: *PId*

Display	Item	Contents	Initial value	User level	Remarks
<i>P - I</i>	P (Proportional band)	0.1 to 999.9%	5.0	0	Displayed when the control method is other than the ON/OFF control (Ctrl≠0).
<i>I - I</i>	I (Integral time)	0 to 9999s (No integration control action when set at "0".)	120	0	
<i>d - I</i>	D (Derivative time)	0 to 9999s (No derivative control action when set at "0".)	30	0	
<i>rE - I</i>	Manual reset	-10.0 to +110.0%	50.0	0	Displayed when the control method is other than the ON/OFF control (Ctrl≠0) and the I (Integral time) (I-1) is "0".
<i>oL - I</i>	MV low limit	-10.0 to +110.0%	0.0	1	Displayed when the control method is other than the ON/OFF control (Ctrl≠0).
<i>oH - I</i>	MV high limit	-10.0 to +110.0%	100.0	1	
<i>P - IC</i>	P (Proportional band) (cool)	0.1 to 999.9%	5.0	0	Displayed when the control method is other than the ON/OFF control (Ctrl≠0) and the Heat/Cool control is used (C26 = 1).
<i>I - IC</i>	I (Integral time) (cool)	0 to 9999s (No integration control action when set at "0".)	120	0	
<i>d - IC</i>	D (Derivative time) (cool)	0 to 9999s (No derivative control action when set at "0".)	30	0	
<i>oL IC</i>	Output low limit (Cool)	-10.0 to +110.0%	0.0	1	
<i>oH IC</i>	Output high limit (Cool)	-10.0 to +110.0%	100.0	1	

■ Parameter bank

Bank selection: *PARA*

Display	Item	Contents	Initial value	User level	Remarks
<i>Ctrl</i>	Control method	0: ON/OFF control 1: Fixed PID 2: ST (Self-tuning)	0 or 1	0	The initial value is "0" when control output 1 is relay output. The initial value is "1" in other cases.
<i>Atol</i>	MV low limit at AT	-10.0 to +110.0%	0.0	0	Displayed when the control method is other than the ON/OFF control (Ctrl≠0).
<i>Atoh</i>	MV high limit at AT	-10.0 to +110.0%	100.0	0	
<i>diff</i>	Differential (for ON/OFF control)	0 to 9999U	5	0	Displayed when the control method is other than the ON/OFF control (Ctrl≠0).
<i>offs</i>	ON/OFF control action point offset	-1999 to +9999U	0	2	
<i>FL</i>	PV filter	0 to 120.0s	0.0	0	
<i>rA</i>	PV ratio	0.001 to 9.999	1.000	1	
<i>bl</i>	PV bias	-1999 to +9999U	0	0	
<i>CYU</i>	Time proportional cycle unit 1	0: Unit of "1s" 1: Fixed at "0.5s". (Cycle time setting is disabled.) 2: Fixed at "0.2s". (Cycle time setting is disabled.) 3: Fixed at "0.1s". (Cycle time setting is disabled.)	0	2	Displayed when MV1 (time proportional output (heat) of Heat/Cool control) is connected to the relay control output, voltage pulse output, or event output in the DO Assignment. The initial value of Time proportional cycle 1 is "10" when the control output is the relay output. The initial value is "2" in other cases.
<i>CY</i>	Time proportional cycle 1	5 to 120s (Output includes the relay output.) 1 to 120s (Output does not include the relay output.)	10 or 2	0	
<i>CYU2</i>	Time proportional cycle unit 2	0: Unit of "1s" 1: Fixed at "0.5s" (Cycle time setting is disabled.) 2: Fixed at "0.2s". (Cycle time setting is disabled.) 3: Fixed at "0.1s". (Cycle time setting is disabled.)	0	2	Displayed when the Heat/Cool control is used (C26=1) and MV2 (time proportional output (heat) of Heat/Cool control) is connected to the relay control output, voltage pulse control output, or event output. The initial value of Time proportional cycle 2 is "10" when the model has one control output point. The initial value is "2" in other cases.
<i>CY2</i>	Time proportional cycle 2	5 to 120s (Output includes the relay output.) 1 to 120s (Output does not include the relay output.)	10 or 2	0	
<i>EPly</i>	Time proportional cycle mode	0: Controllability aiming type 1: Operation end service life aiming type (Only one ON/OFF operation within Time proportional cycle)	0 or 1	2	The initial value is "1" when control output 1 is the relay output. The initial value is "0" in other cases.
<i>SPU</i>	SP up ramp	0.0 to 999.9U (No ramp when set at "0.0U")	0.0	2	Time unit of the ramp is selected by the SP ramp unit (C32).
<i>SPd</i>	SP down ramp		0.0	2	

■ Extended tuning bank

Bank selection: *Et*

Display	Item	Contents	Initial value	User level	Remarks	
<i>Atty</i>	AT type	0: Normal (Standard control characteristics) 1: Immediate response (Control characteristics that respond immediately to external disturbance.) 2: Stable (Control characteristics having less up/down fluctuation of PV)	1	0	Displayed when the control method is other than the ON/OFF control (Ctrl≠0).	
<i>JFbd</i>	Just-FITTER settling band	0.00 to 10.00	0.30	2		
<i>SPLG</i>	SP lag constant	0.0 to 999.9	0.0	2		
<i>At-P</i>	Proportional band tuning factor at AT	0.00 to 99.99	1.00	2		
<i>At-I</i>	Integral time adjust	0.00 to 99.99	1.00	2		
<i>At-d</i>	AT Derivative time adjust	0.00 to 99.99	1.00	2		
<i>CtrlA</i>	Control algorithm	0: PID (Conventional PID) 1: Ra-PID (High-performance PID)	0	1		
<i>JFou</i>	Just-FITTER overshoot suppression factor	0 to 100	0	1		
<i>StSA</i>	ST (Self-tuning) step execution resolution band	0.00 to 99.99	10.00	2		Displayed when the control method is other than the ON/OFF control (Ctrl≠0) and the control method is ST (Ctrl = 2).
<i>StSb</i>	ST (Self-tuning) step settling band	0.00 to 10.00	0.50	2		
<i>StHb</i>	ST (Self-tuning) hunting settling band	0.00 to 10.00	1.00	2		
<i>StUd</i>	ST (Self-tuning) step ramp change	0: ST is executed when the PV moves up or down. 1: ST is executed only when the PV moves up.	0	1		

6 - 3 List of Setup Setting Displays

The following shows the meanings of the values stated in the “User Level” column:

0: Simple, Standard, or High function configuration, 1: Standard or High function configuration, and 2: High function configuration

Initial value may depending on model No.

■ Setup bank

Bank selection: *SETUP*

Display	Item	Contents	Initial value	User level	Remarks
C 01	PV input range type	When the PV input type is thermocouple (T): 1 to 6, 9 to 11, 13 to 21, 24, 25	1	0	For details, refer to the PV Input Range Table (on page 5-2).
		When the PV input type is RTD (R): 41 to 46, 51 to 54, 63, 64, 67, 68	41		
		When the PV input type is DC voltage/DC current (L): 84, 86 to 90	88		
C 02	Temperature unit	0: Celsius (°C) 1: Fahrenheit (°F)	0	0	Displayed when the PV input type is thermocouple (T) or RTD (R).
C 03	Cold junction compensation (T/C)	0: Cold junction compensation (T/C) is performed (internal). 1: Cold junction compensation (T/C) is not performed (external).	0	2	Displayed when the PV input type is thermocouple (T).
C 04	Decimal point position	0: No decimal point 1: 1 digit after decimal point 2: 2 digits after decimal point 3: 3 digits after decimal point	0	0	Displayed when the PV input type is DC voltage/DC current (L) or RTD having the range with the decimal point.
C 05	PV input range low limit	When the PV input type is thermocouple (T) or RTD (R), the input range low limit selected with the PV input range type (C01) is displayed, but the setting is disabled.	—	0	
		When the PV input type is DC voltage/DC current, a value ranging from -1999 to +9999 is set.	0		
C 06	PV input range high limit	When the PV input type is thermocouple (T) or RTD (R), the input range low limit selected with the PV input range type (C01) is displayed, but the setting is disabled.	—	0	
		When the PV input type is DC voltage/DC current, a value ranging from -1999 to +9999 is set.	1000		
C 07	SP low limit	PV input range low limit to PV input range high limit	—	1	
C 08	SP high limit		—	1	
C 09	PV square root extraction dropout	0.0 to 100.0 (PV square root extraction is not performed when set at “0.0”.)	0.0	2	Displayed when the PV input type is DC voltage/DC current (L).
C 14	Control action (Direct/Reverse)	0: Heat control (Reverse action) 1: Cool control (Direct action)	0	0	
C 15	Output operation at PV alarm	0: Control calculation is continued. 1: Output at PV alarm is output.	0	2	
C 16	Output at PV alarm	-10.0 to +110.0%	0.0	2	
C 17	Output at READY (Heat)	-10.0 to +110.0%	0.0	1	
C 18	Output at READY (Cool)	-10.0 to +110.0%	0.0	1	Displayed when the control method is other than the ON/OFF control (Ctrl≠0) and the heat/cool control (C26 = 1) is used.

Display	Item	Contents	Initial value	User level	Remarks
[19	Output operation at changing Auto/Manual	0: Bumpless transfer 1: Preset	0	1	Displayed when the control method is other than the ON/OFF control (Ctrl≠0). When the operation mode is the MANUAL mode at power ON, the preset MANUAL value (C20) becomes the Manipulated Variable (MV).
[20	Preset MANUAL value	-10.0 to +110.0%	0.0 or 50.0	1	
[21	Initial output type (mode) of PID control	0: Auto 1: Not initialized. 2: Initialized (If SP value different from the current value is input.)	0	2	
[22	Initial output of PID control	-10.0 to +110.0%	0.0 or 50.0	2	
[26	Heat/Cool control	0: Not used. 1: Used.	0	0	Displayed when the control method is other than the ON/OFF control (Ctrl≠0). When set at "1", the control action is set to the reverse action (C14 = 0), the preset MANUAL value (C20) is set to "50.0", and the initial output of the PID control (C22) is changed to "50.0".
[27	Heat/Cool selection	0: Normal 1: Energy saving	0	1	Displayed when the Heat/Cool control is used (C26 = 1).
[28	Heat/Cool control dead zone	-100.0 to +100.0%	0.0	0	
[29	Heat/Cool control change point	-10.0 to +110.0%	50.0	2	
[30	LSP system group	1 to 4	1	0	
[32	SP ramp unit	0: 0.1U/s 1: 0.1U/min 2: 0.1U/h	0	2	"0.1U" shows that the decimal point position of the PV is shifted one digit rightward.
[36	CT1 operation type	0: Heater burnout detection 1: Current value measurement	0	0	Displayed when the optional model has two current transformer input points.
[37	CT1 output	0: Control output 1 1: Control output 2 2: Event output 1 3: Event output 2 4: Event output 3	0	0	Displayed when the optional model has two current transformer input points and the CT1 operation type is set at "heater burnout detection" (C36 = 0).
[38	CT1 measurement wait time	30 to 300ms	30	0	
[39	CT2 operation type	Same as CT1	0	0	Displayed when the optional model has two current transformer input points.
[40	CT2 output	Same as CT1	0	0	Displayed when the optional model has two current transformer input points and the CT2 operation type is set at "heater burnout detection" (C39 = 0).
[41	CT2 measurement wait time	Same as CT1	30	0	

Chapter 6. LIST OF DISPLAYS AND SETTING DATA

Display	Item	Contents	Initial value	User level	Remarks
[42	Control output 1 range	1: 4 to 20mA 2: 0 to 20mA	1	0	Displayed when control output 1 of the model is the current output. The decimal point position of the scaling low limit/high limit becomes 1 digit after the decimal point when the control output 1 type is related to the MV and CT. When the control output 1 type is related to the PV and SP, the decimal point position becomes the same as that of the PV.
[43	Control output 1 type	0: MV 1: Heat MV (for heat/cool control) 2: Cool MV (for heat/cool control) 3: PV 4: PV before ratio, bias, and filter 5: SP 6: Deviation 7: CT1 current value 8: CT2 current value 9: MFB (Invalid on SDC15)	0	0	
[44	Control output 1 scaling low limit	-1999 to +9999 The decimal point position may vary depending on control output 1 type (C43).	0	0	
[45	Control output 1 scaling high limit		100.0	0	
[47	Control output 2 range	1: 4 to 20mA 2: 0 to 20mA	1	0	Displayed when control output 2 of the model is the current output. The decimal point position of the scaling low limit/high limit becomes 1 digit after the decimal point when the control output 2 type is related to the MV and CT. When the control output 2 type is related to the PV and SP, the decimal point position becomes the same as that of the PV.
[48	Control output 2 type	0: MV 1: Heat MV (for heat/cool control) 2: Cool MV (for heat/cool control) 3: PV 4: PV before ratio, bias, and filter 5: SP 6: Deviation 7: CT1 current value 8: CT2 current value 9: MFB (Invalid on SDC15)	3	0	
[49	Control output 2 scaling low limit	-1999 to +9999 The decimal point position may vary depending on control output 2 type (C48).	0	0	
[50	Control output 2 scaling high limit		1000	0	
[64	CPL/MODBUS	0: CPL 1: MODBUS (ASCII format) 2: MODBUS (RTU format)	0	0	Displayed when the optional model has RS-485.
[65	Station address	0 to 127 (Communication is disabled when set at "0".)	0	0	
[66	Transmission speed	0: 4800bps 1: 9600bps 2: 19200bps 3: 38400bps	2	0	
[67	Data format (Data length)	0: 7 bits 1: 8 bits	1	0	
[68	Data format (Parity)	0: Even parity 1: Odd parity 2: No parity	0	0	
[69	Data format (Stop bit)	0: 1 bit 1: 2 bits	0	0	
[70	Response time-out	1 to 250ms	3	2	

Display	Item	Contents	Initial value	User level	Remarks
[71	Key operation type	0: Standard type 1: Special type	0	2	
[72	[mode] key function	0: Invalid 1: AUTO/MANUAL selection 2: RUN/READY selection 3: AT Stop/Start 4: LSP group selection 5: Release all DO latches 6: Invalid 7: Communication DI1 selection 8: Invalid	0	0	
[73	MODE display setup	Whether or not the mode bank setup is displayed is determined by the sum of the following weights: Bit 0: AUTO/MANUAL display Disabled: 0, Enabled: +1 Bit 1: RUN/READY display Disabled: 0, Enabled: +2 Bit 3: AT stop/start display Disabled: 0, Enabled: +8 Bit 4: Release all DO latches display Disabled: 0, Enabled: +16 Bit 5: Communication DI1 ON/OFF display Disabled: 0, Enabled: +32 Other invalid settings, 0, +4, +64, +128	255	1	
[74	PV/SP display setup	Whether or not the PV/SP value related items are displayed in the basic display mode is determined by the sum of the following weights: Bit 0: PV display Disabled: 0, Enabled: +1 Bit 1: SP display Disabled: 0, Enabled: +2 Bit 2: LSP group number display Disabled: 0, Enabled: +4 Other invalid settings, 0, +8	15	1	
[75	MV display setup	Whether or not the PV/SP value related items are displayed in the basic display mode is determined by the sum of the following weights: Bit 0: MV display Disabled: 0, Enabled: +1 Bit 1: Heat MV/cool MV display Disabled: 0, Enabled: +2 Bit 3: AT progress display Disabled: 0, Enabled: +8 Other invalid settings, 0, +4	15	1	
[76	EV display setup (Setup setting/Setup bank)	0: Internal Event set value is not displayed in the operation display mode. 1: Set value of Internal Event 1 is displayed in the operation display mode. 2: Set values of Internal Events 1 to 2 are displayed in the operation display mode. 3: Set values of Internal Events 1 to 3 are displayed in the operation display mode.	0	1	

Chapter 6. LIST OF DISPLAYS AND SETTING DATA

Display	Item	Contents	Initial value	User level	Remarks
[77	Timer remain time display setup	0: ON/OFF delay remain time of Internal Event is not displayed in the operation display mode. 1: ON/OFF delay remain time of Internal Event 1 is displayed in the operation display mode. 2: ON/OFF delay remain time of Internal Events 1 to 2 is displayed in the operation display mode. 3: ON/OFF delay remain time of Internal Events 1 to 3 is displayed in the operation display mode.	0	1	
[78	CT display setup	0: CT current value is not displayed in the operation display mode. 1: CT1 current value is displayed in the operation display mode. 2: CT1 to 2 current values are displayed in the operation display mode.	0	1	
[79	User level	0: Simple configuration 1: Standard configuration 2: High function configuration	0	0	
[80	Communication monitor display	0: Not used. 1: Flashing while data is sending through RS-485 communication. 2: Flashing while data is receiving through RS-485 communication. 3: Logical OR of all DI statuses 4: Flashing in READY mode	0	2	

■ Event configuration bank

Bank selection: *EULF*

Display	Item	Contents	Initial value	User level	Remarks
<i>E 1.1</i>	Internal Event 1 Configuration 1 Operation type	0: No event 1: PV high limit 2: PV low limit 3: PV high/low limit 4: Deviation high limit 5: Deviation low limit 6: Deviation high/low limit 7: Deviation high limit (Final SP reference) 8: Deviation low limit (Final SP reference) 9: Deviation high/low limit (Final SP reference) 10: SP high limit 11: SP low limit 12: SP high/low limit 13: MV high limit 14: MV low limit 15: MV high/low limit 16: CT1 heater burnout/over-current 17: CT1 heater short-circuit 18: CT2 heater burnout/over-current 19: CT2 heater short-circuit 20: Loop diagnosis 1 21: Loop diagnosis 2 22: Loop diagnosis 3 23: Alarm (status) 24: READY (status) 25: MANUAL (status) 26: Invalid 27: During AT execution (status) 28: During SP ramp (status) 29: Control direct action (status) 30: During ST execution (status) 31: Invalid 32: Timer (status)	0	0	
<i>E 1.2</i>	Internal Event 1 Configuration 2	The digits are determined to 1st digit, 2nd digit, 3rd digit, and 4th digit from the right end.	0000	0	
	1st digit: Direct/ Reverse	0: Direct 1: Reverse			
	2nd digit: Standby	0: None 1: Standby 2: Standby + Standby at SP change			
	3rd digit: EVENT state at READY	0: Continue 1: Forced OFF			
	4th digit: Undefined	0			

Chapter 6. LIST OF DISPLAYS AND SETTING DATA

Display	Item	Contents	Initial value	User level	Remarks
<i>E 1.C3</i>	Internal Event Configuration 3	The digits are determined to 1st digit, 2nd digit, 3rd digit, and 4th digit from the right end.	0000	2	
	1st digit: Controller alarm OR	0: None 1: Alarm direct + OR operation 2: Alarm direct + AND operation 3: Alarm reverse + OR operation 4: Alarm reverse + AND operation			
	2nd digit: Special OFF setup	0: As usual. 1: When the event set value (main setting) is "0", the event is "OFF".			
	3rd digit: Delay unit	0: 0.1s 1: 1s 2: 1min			
	4th digit: Undefined.	0			
<i>E 2.C1</i>	Internal Event 2 Configuration 1 Operation type	Same as Internal Event 1 Configuration 1.	0	0	
<i>E 2.C2</i>	Internal Event 2 Configuration 2 1st digit: Direct/Reverse 2nd digit: Standby 3rd digit: EVENT state at READY 4th digit: Undefined.	Same as Internal Event 1 Configuration 2.	0000	0	
<i>E 2.C3</i>	Internal Event 2 Configuration 3 1st digit: Controller alarm OR 2nd digit: Special OFF setup 3rd digit: Delay unit 4th digit: Undefined.	Same as Internal Event 1 Configuration 3.	0000	2	
<i>E 3.C1</i>	Internal Event 3 Configuration 1 Operation type	Same as Internal Event 1 Configuration 1.	0	0	
<i>E 3.C2</i>	Internal Event 3 Configuration 2 1st digit: Direct/Reverse 2nd digit: Standby 3rd digit: EVENT state at READY 4th digit: Undefined.	Same as Internal Event 1 Configuration 2.	0000	0	
<i>E 3.C3</i>	Internal Event 3 Configuration 3 1st digit: Controller alarm OR 2nd digit: Special OFF setup 3rd digit: Delay unit 4th digit: Undefined.	Same as Internal Event 1 Configuration 3.	0000	2	
<i>E 4.C1</i>	Internal Event 4 Configuration 1 Operation type	Same as Internal Event 1 Configuration 1.	0	0	
<i>E 4.C2</i>	Internal Event 4 Configuration 2 1st digit: Direct/Reverse 2nd digit: Standby 3rd digit: EVENT state at READY 4th digit: Undefined.	Same as Internal Event 1 Configuration 2.	0000	2	

Display	Item	Contents	Initial value	User level	Remarks
<i>E4C3</i>	Internal Event 4 Configuration 3 1st digit: Controller alarm OR 2nd digit: Special OFF setup 3rd digit: Delay unit 4th digit: Undefined.	Same as Internal Event 1 Configuration 3.	0000	2	
<i>E5C1</i>	Internal Event 5 Configuration 1 Operation type	Same as Internal Event 1 Configuration 1.	0	0	
<i>E5C2</i>	Internal Event 5 Configuration 2 1st digit: Direct/Reverse 2nd digit: Standby 3rd digit: EVENT state at READY 4th digit: Undefined.	Same as Internal Event 1 Configuration 2.	0000	0	
<i>E5C3</i>	Internal Event 5 Configuration 3 1st digit: Controller alarm OR 2nd digit: Special OFF setup 3rd digit: Delay unit 4th digit: Undefined.	Same as Internal Event 1 Configuration 3.	0000	2	

■ DI Assignment bank

Bank selection: *dl*

Display	Item	Contents	Initial value	User level	Remarks
<i>dl 11</i>	Internal Contact 1 Operation type	0: No function 1: LSP group selection (0/+1) 2: LSP group selection (0/+2) 3: LSP group selection (0/+4) 4 to 6: Invalid 7: RUN/READY selection 8: AUTO/MANUAL selection 9: Invalid 10: AT Stop/Start 11: ST disabled/enabled 12: Control action direct/reverse selection (As setting/opposite operation of setting) 13: SP RAMP enabled/disabled 14: PV Hold (No-hold/Hold) 15: PV maximum value hold (No-hold/Hold) 16: PV minimum value hold (No-hold/Hold) 17: Timer Stop/Start 18: Release all DO latches (Continue/Release) 19 to 20: Invalid	0	0	
<i>dl 12</i>	Internal Contact 1 Input bit function	0: Not used (Default input) 1: Function 1 ((A and B) or (C and D)) 2: Function 2 ((A or B) and (C or D)) 3: Function 3 (A or B or C or D) 4: Function 4 (A and B and C and D)	0	2	When using internal contact 1, the default input is DI (digital input) 1.
<i>dl 13</i>	Internal Contact 1 Input assign A	0: Normally opened. (OFF, 0) 1: Normally closed. (ON, 1) 2: DI1 3: DI2 4 to 9: Undefined.	2	2	Displayed when internal contact 1 Input bit function is function 1 to 4 (dl1.2≠0).
<i>dl 14</i>	Internal Contact 1 Input assign B	10: Internal Event 1 11: Internal Event 2 12: Internal Event 3 13: Internal Event 4 14: Internal Event 5	0	2	
<i>dl 15</i>	Internal Contact 1 Input assign C	15 to 17: Undefined. 18: Communication DI1 19: Communication DI2 20: Communication DI3 21: Communication DI4	0	2	
<i>dl 16</i>	Internal Contact 1 Input assign D	22: MANUAL mode 23: READY mode 24: Undefined. 25: AT running 26: During SP ramp 27: Undefined. 28: Alarm occurs. 29: PV alarm occurs. 30: Undefined. 31: mode key pressing status 32: Event output 1 status 33: Control output 1 status	0	2	

Display	Item	Contents	Initial value	User level	Remarks
<i>dl 17</i>	Internal Contact 1 Polarity A to D	The digits are determined to 1st digit, 2nd digit, 3rd digit, and 4th digit from the right end.	0000	2	Displayed when internal contact 1 Input bit function is function 1 to 4 (dl1.2≠0).
	1st digit: Polarity A (Polarity of Input assign A)	0: Direct 1: Reverse			
	2nd digit: Polarity B (Polarity of Input assign B)				
	3rd digit: Polarity C (Polarity of Input assign C)				
	4th digit: Polarity D (Polarity of Input assign D)				
<i>dl 18</i>	Internal Contact 1 Polarity	0: Direct 1: Reverse	0	2	
<i>dl 19</i>	Internal Contact 1 Event channel def.	0: Every Internal Event 1 to 5: Internal Event No.	0	2	Displayed when the operation type of internal contact 1 is timer stop/start (dl1.1 = 17).
<i>dl 2.1</i>	Internal Contact 2 Operation type	Same as Internal Contact 1 Operation type. 0 to 20	0	0	
<i>dl 2.2</i>	Internal Contact 2 Input bit function	Same as Internal Contact 1 Input bit function. 0: Not used. (Default input) 1 to 4: Function 1 to 4	0	2	When using internal contact 2, the default input is DI (digital input) 2.
<i>dl 2.3</i>	Internal Contact 2 Input assign A	Same as Internal Contact Input assign A to D. 0 to 33	3	2	Displayed when internal contact 2 Input bit function is function 1 to 4 (dl2.2≠0).
<i>dl 2.4</i>	Internal Contact 2 Input assign B		0	2	
<i>dl 2.5</i>	Internal Contact 2 Input assign C		0	2	
<i>dl 2.6</i>	Internal Contact 2 Input assign D		0	2	
<i>dl 2.7</i>	Internal Contact 2 Polarity A to D 1st digit: Polarity A 2nd digit: Polarity B 3rd digit: Polarity C 4th digit: Polarity D	Same as Internal Contact 1 Polarity A to D The following setting applies to each digit: 0: Direct 1: Reverse	0000	2	
<i>dl 2.8</i>	Internal Contact 2 Polarity	0: Direct 1: Reverse	0	2	
<i>dl 2.9</i>	Internal Contact 2 Event channel def.	0: Every Internal Event 1 to 5: Internal Event No.	0	2	Displayed when the operation type of internal contact 2 is timer stop/start (dl2.1 = 17).
<i>dl 3.1</i>	Internal Contact 3 Operation type	Same as Internal Contact 1 Operation type. 0 to 20	0	0	
<i>dl 3.2</i>	Internal Contact 3 Input bit function	Same as Internal Contact 1 Input bit function. 0: Not used. (Default input) 1 to 4: Function 1 to 4	0	2	When using internal contact 3, the default input is invalid.

Chapter 6. LIST OF DISPLAYS AND SETTING DATA

Display	Item	Contents	Initial value	User level	Remarks
<i>d1 33</i>	Internal Contact 3 Input assign A	Same as Internal Contact Input assign A to D. 0 to 33	4	2	Displayed when internal contact 3 Input bit function is function 1 to 4 (dl3.2≠0).
<i>d1 34</i>	Internal Contact 3 Input assign B		0	2	
<i>d1 35</i>	Internal Contact 3 Input assign C		0	2	
<i>d1 36</i>	Internal Contact 3 Input assign D		0	2	
<i>d1 37</i>	Internal Contact 3 Polarity A to D 1st digit: Polarity A 2nd digit: Polarity B 3rd digit: Polarity C 4th digit: Polarity D	Same as Internal Contact 1 Polarity A to D The following setting applies to each digit: 0: Direct 1: Reverse	0000	2	
<i>d1 38</i>	Internal Contact 3 Polarity	0: Direct 1: Reverse	0	2	
<i>d1 39</i>	Internal Contact 3 Event channel def.	0: Every Internal Event 1 to 5: Internal Event No.	0	2	Displayed when the operation type of internal contact 3 is timer stop/start (dl3.1 = 17).

■ DO Assignment bank

Bank selection: *do*

Display	Item	Contents	Initial value	User level	Remarks
<i>ot 11</i>	Control output 1 Operation type	0: Default output 1: MV 1 (ON/OFF control output, time proportional output, and time proportional output (heat) of Heat/Cool control.) 2: MV2 (Time proportional output (cool) of Heat/Cool control) 3: Function 1 ((A and B) or (C and D)) 4: Function 2 ((A or B) and (C or D)) 5: Function 3 (A or B or C or D) 6: Function 4 (A and B and C and D)	0	2	Displayed when control output 1 of the model is relay output or voltage pulse output. When using control output 1, the default output is MV1.
<i>ot 12</i>	Control output 1 Output assign A	0: Normally opened. (OFF, 0) 1: Normally closed. (ON, 1) 2: Internal Event 1 3: Internal Event 2 4: Internal Event 3 5: Internal Event 4 6: Internal Event 5 7 to 13: Undefined.	14	2	Displayed when control output 1 of the model is relay output or voltage pulse output, and the operation type of control output 1 is function 1 to 4 (<i>ot1.1</i> > 2).
<i>ot 13</i>	Control output 1 Output assign B	14: MV1 15: MV2 16 to 17: Undefined. 18: DI1 19: DI2 20 to 25: Undefined. 26: Internal Contact 1 27: Internal Contact 2 28: Internal Contact 3 29 to 33: Undefined.	0	2	
<i>ot 14</i>	Control output 1 Output assign C	34: Communication DI1 35: Communication DI2 36: Communication DI3 37: Communication DI4 38: MANUAL mode 39: READY mode 40: Undefined.	0	2	
<i>ot 15</i>	Control output 1 Output assign D	41: AT running 42: During SP ramp 43: Undefined. 44: Alarm occurs. 45: PV alarm occurs. 46: Undefined. 47: mode key pressing status 48: Event output 1 status 49: Control output 1 status	0	2	

Chapter 6. LIST OF DISPLAYS AND SETTING DATA

Display	Item	Contents	Initial value	User level	Remarks
ot 16	Control output 2 Polarity A to D 1st digit: Polarity A 2nd digit: Polarity B 3rd digit: Polarity C 4th digit: Polarity D	The digits are determined to 1st digit, 2nd digit, 3rd digit, and 4th digit from the right end. 0: Direct 1: Reverse	0000	2	
ot 17	Control output 1 Polarity	0: Direct 1: Reverse	0	2	
ot 18	Control output 1 Latch	0: None 1: Latch (Latch at ON) 2: Latch (Latch at OFF except for initialization at power ON)	0	2	
ot 21	Control output 2 Operation type	Same as Control output 1 Operation type. 0: Default output 1: MV1 2: MV2 3 to 6: Function 1 to 4	0	2	Displayed when control output 2 of the model is voltage pulse output. When using control output 2, the default output is MV2.
ot 22	Control output 2 Output assign A	Same as Control output 1 Output assign A to D. 0 to 49	15	2	Displayed when control output 2 of the model is voltage pulse output and the operation type of control output 2 is function 1 to 4 (ot2.1 > 2).
ot 23	Control output 2 Output assign B		0	2	
ot 24	Control output 2 Output assign C		0	2	
ot 25	Control output 2 Output assign D		0	2	
ot 26	Control output 2 Polarity A to D 1st digit: Polarity A 2nd digit: Polarity B 3rd digit: Polarity C 4th digit: Polarity D	Same as Control output 1 Polarity A to D. The following setting applies to each digit: 0: Direct 1: Reverse	0000	2	
ot 27	Control output 2 Polarity	0: Direct 1: Reverse	0	2	
ot 28	Control output 2 Latch	0: None 1: Latch (Latch at ON) 2: Latch (Latch at OFF except for initialization at power ON)	0	2	

Display	Item	Contents	Initial value	User level	Remarks
<i>Ev 1.1</i>	Event output 1 Operation type	Same as Control output 1 Operation type. 0: Default output 1: MV1 2: MV2 3 to 6: Function 1 to 4	0	2	Displayed when the optional model has Event output 1. When using Event output 1, the default output is Internal Event 1.
<i>Ev 1.2</i>	Event output 1 Output assign A	Same as Control output 1 Output assign A to D. 0 to 49	2	2	
<i>Ev 1.3</i>	Event output 1 Output assign B		0	2	
<i>Ev 1.4</i>	Event output 1 Output assign C		0	2	
<i>Ev 1.5</i>	Event output 1 Output assign D		0	2	
<i>Ev 1.6</i>	Event output 1 Polarity A to D 1st digit: Polarity A 2nd digit: Polarity B 3rd digit: Polarity C 4th digit: Polarity D	Same as Control output 1 Polarity A to D. The following setting applies to each digit: 0: Direct 1: Reverse	0000	2	Displayed when the optional model has Event output 1 and the operation type of Event output 1 is function 1 to 4 (Ev1.1 > 2).
<i>Ev 1.7</i>	Event output 1 Polarity	0: Direct 1: Reverse	0	2	
<i>Ev 1.8</i>	Event output 1 Latch	0: None 1: Latch (Latch at ON) 2: Latch (Latch at OFF except for initialization at power ON)	0	2	
<i>Ev 2.1</i>	Event output 2 Operation type	Same as Control output 1 Operation type. 0: Default output 1: MV1 2: MV2 3 to 6: Function 1 to 4	0	2	
<i>Ev 2.2</i>	Event output 2 Output assign A	Same as Control output 1 Output assign A to D. 0 to 49	3	2	Displayed when the optional model has Event output 2 and the operation type of Event output 2 is function 1 to 4 (Ev2.1 > 2).
<i>Ev 2.3</i>	Event output 2 Output assign B		0	2	
<i>Ev 2.4</i>	Event output 2 Output assign C		0	2	
<i>Ev 2.5</i>	Event output 2 Output assign D		0	2	
<i>Ev 2.6</i>	Event output 2 Polarity A to D 1st digit: Polarity A 2nd digit: Polarity B 3rd digit: Polarity C 4th digit: Polarity D	Same as Control output 1 Polarity A to D. The following setting applies to each digit: 0: Direct 1: Reverse	0000	2	Displayed when the optional model has Event output 2.
<i>Ev 2.7</i>	Event output 2 Polarity	0: Direct 1: Reverse	0	2	
<i>Ev 2.8</i>	Event output 2 Latch	0: None 1: Latch (Latch at ON) 2: Latch (Latch at OFF except for initialization at power ON)	0	2	

Chapter 6. LIST OF DISPLAYS AND SETTING DATA

Display	Item	Contents	Initial value	User level	Remarks
<i>Ev3.1</i>	Event output 3 Operation type	Same as Control output 1 Operation type. 0: Default output 1: MV1 2: MV2 3 to 6: Function 1 to 4	0	2	Displayed when the optional model has Event output 3. When using Event output 3, the default output is Internal Event 3.
<i>Ev3.2</i>	Event output 3 Output assign A	Same as Control output 1 Output assign A to D. 0 to 49	4	2	
<i>Ev3.3</i>	Event output 3 Output assign B		0	2	
<i>Ev3.4</i>	Event output 3 Output assign C		0	2	
<i>Ev3.5</i>	Event output 3 Output assign D		0	2	
<i>Ev3.6</i>	Event output 3 Polarity A to D 1st digit: Polarity A 2nd digit: Polarity B 3rd digit: Polarity C 4th digit: Polarity D	Same as Control output 1 Polarity A to D. The following setting applies to each digit: 0: Direct 1: Reverse	0000	2	
<i>Ev3.7</i>	Event output 3 Polarity	0: Direct 1: Reverse	0	2	
<i>Ev3.8</i>	Event output 3 Latch	0: None 1: Latch (Latch at ON) 2: Latch (Latch at OFF except for initialization at power ON)	0	2	

■ User Function bank

Bank selection: *UF*

Display	Item	Contents	Initial value	User level	Remarks
<i>UF-1</i>	User Function 1	Each setting is set on the upper display. The following shows the setting exceptions: <i>----</i> : Not registered. <i>P-</i> : P (Proportional band) of currently used PID group <i>I-</i> : I (Integral time) of currently used PID group <i>D-</i> : D (Derivative time) of currently used PID group <i>rE-</i> : Manual reset of currently used PID group <i>oL</i> : Output low limit of currently used PID <i>oH</i> : Output high limit of currently used PID group	----	1	It is possible to register only the settings, which can be displayed. (Example: Manual reset of the PID constant can be registered when the I (Integral time) is set at "0".) The registered setting is added to the end of the display order of the basic display.
<i>UF-2</i>	User Function 2		----	1	
<i>UF-3</i>	User Function 3		----	1	
<i>UF-4</i>	User Function 4		----	1	
<i>UF-5</i>	User Function 5		----	1	
<i>UF-6</i>	User Function 6		----	1	
<i>UF-7</i>	User Function 7		----	1	
<i>UF-8</i>	User Function 8		----	1	

■ Lock bank

Bank selection: *LoC*

Display	Item	Contents	Initial value	User level	Remarks
<i>LoC</i>	Key lock	0: All settings are possible. 1: Mode, event, operation display, SP, UF, lock, manual MV, and mode key can be set. 2: Operation display, SP, UF, lock, manual MV, and mode key can be set. 3: UF, lock, manual MV, and mode key can be set.	0	0	When two sets of passwords (1A and 1B, 2A and 2B) are matched, the setting is possible. [mode] key operation, MV setting in MANUAL mode, key lock, password display, and password 1A to 2B can be set when the key lock (LoC) is a value of 0 to 3.
<i>CLoC</i>	Communication lock	0: RS-485 communication read/write enabled. 1: RS-485 communication read/write disabled.	0	2	
<i>LLoC</i>	Loader lock	0: Loader communication read/write enabled. 1: Loader communication read/write disabled.	0	2	
<i>PASS</i>	Password display	0 to 15 5: Password 1A to 2B display	0	0	Displayed when the password display (PASS) is "5" and two sets of passwords (1A and 1B, 2A and 2B) are matched.
<i>PS1A</i>	Password 1A	0000 to FFFF (Hexadecimal value)	0000	0	
<i>PS2A</i>	Password 2A	0000 to FFFF (Hexadecimal value)	0000	0	Displayed when the password display (PASS) is "5".
<i>PS1B</i>	Password 1B	0000 to FFFF (Hexadecimal value)	0000	0	
<i>PS2B</i>	Password 2B	0000 to FFFF (Hexadecimal value)	0000	0	

■ Instrument information bank

Bank selection: *1 d*

Display	Item	Contents	Initial value	User level	Remarks
<i>1 d01</i>	ROM ID	0: SDC15	0	2	Identification of ROM firmware Setting is disabled.
<i>1 d02</i>	ROM Version 1	XX.XX (2 digits after decimal point)	—	2	
<i>1 d03</i>	ROM Version 2	XX.XX (2 digits after decimal point)	—	2	
<i>1 d04</i>	LOADER Information		—	2	
<i>1 d05</i>	EST Information		—	2	
<i>1 d06</i>	Manufacturing date code (year)	Subtract 2000 from the year. Example: "3" means the year 2003.	—	2	Manufacturing date and unit identification No. Setting is disabled.
<i>1 d07</i>	Manufacturing date code (month, day)	Month + Day divided by 100. Example: "12.01" means the 1st day of December.	—	2	
<i>1 d08</i>	Serial No.		—	2	

Chapter 7. CPL COMMUNICATIONS FUNCTIONS

7 - 1 Outline of Communications

If the optional model number is provided with the RS-485 communications function, communications with a PC, PLC or other host devices are available using a user-prepared program.

The communications protocol can be selected from the CPL communications (Controller Peripheral Link: Yamatake's host communications protocol) and the MODBUS communications. This chapter describes the CPL communications.

■ Features

The features of the SDC15's communications functions are as follows:

- Up to 31 SDC15 units can be connected to a single master station as a host device.
- When the communications specifications of the host device conform to the RS-232C interface, the communications converter CMC10L (sold separately) is required.

The CMC10L allows you to perform the conversion between RS-232C and RS-485.

- Almost all of the parameters held by the device can be communicated.

For details on communications parameters,

 refer to Chapter 9, LIST OF COMMUNICATION DATA.

- Random access commands are available.

Two or more number of parameters at separated addresses can be read or written by a single command.

■ Setup

The following setups are required for performing the CPL communications:

The items on the table below can be displayed and set up only when the optional model number is provided with the RS-485 communications function.

Item (Setting display/bank)	Display	Contents	Initial value	User level
CPL/MODBUS (Setup setting/Setup bank)	Ⓒ 54	0: CPL 1: MODBUS ASCII format 2: MODBUS RTU format	0	Simple, Standard, High function
Station address (Same as above)	Ⓒ 55	0: Does not communicate 1 to 127	0	
Transmission speed (Same as above)	Ⓒ 56	0: 4800bps 1: 9600bps 2: 19200bps 3: 38400bps	2	
Data format (Data length) (Same as above)	Ⓒ 57	0: 7-bit 1: 8-bit	1	
Data format (Parity) (Same as above)	Ⓒ 58	0: Even parity 1: Odd parity 2: No parity	0	
Data format (Stop bit) (Same as above)	Ⓒ 59	0: 1 stop bit 1: 2 stop bits	0	
Response time-out	Ⓒ 70	1 to 250 ms	3	

Handling Precautions

- Setups can be performed through key operation on the console or the smart loader package SLP-C35. However, they cannot be performed via RS-485 communications.
- If you use the Yamatake CMC10L as an RS-232C/RS-485 converter, set the response time-out (C70) to 3 ms or longer.

■ Communications procedures

The communications procedure is as follows:

- (1) The instruction message is sent from the host device (master station) to one SDC15 unit (slave station) to communicate with.
- (2) The slave station receives the instruction message, and performs read or write processing according to the content of the message.
- (3) The slave station sends a message corresponding to the processing content as a response message.
- (4) The master station receives the response message.

❗ Handling Precautions

It is not allowed to use two or more number of protocols together on one and the same RS-485 transmission line such as CPL, MODBUS ASCII format, and MODBUS RTU format.

7 - 2 Message Structure

■ Message structure

The following shows the message structure:

Messages are broadly classified into two layers: the data link layer and the application layer.

- Data link layer

This layer contains the basic information required for communications such as the destination of the communications message and the check information of the message.

- Application layer

Data is read and written in this layer. The content of the layer varies according to the purpose of the message.

Messages comprise parts (1) to (9) as shown in the figure below.

The command (details sent from the master station) and the response (details returned from the slave station) are stored in the application layer.

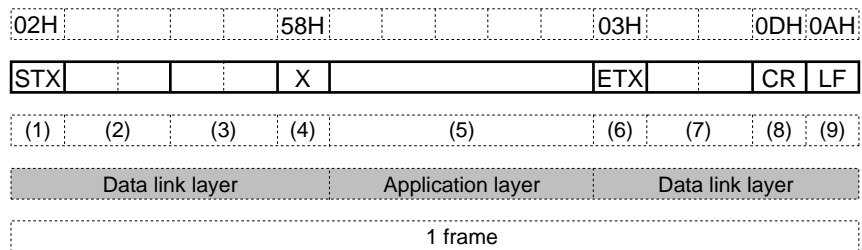

- | | |
|--|-----------------------------------|
| (1) STX (start of message) | (6) ETX (end of command/response) |
| (2) Station address | (7) Checksum |
| (3) Sub-address | (8) CR (delimiter) |
| (4) Device ID code | (9) LF (delimiter) |
| (5) Send message = command,
response message = response | |

■ Data link layer

- Outline

The data link layer is of a fixed length. The position of each data item and the number of its characters are already decided. Note, however, that the data positions of the data link layer from ETX onwards shift according to the number of characters in the application layer. The character length, however, remains unchanged.

- Response start conditions

- The device sends the response message only when (1) message structure, station address, sub-address, checksum and message length of a single frame in the data link layer are all correct. If even one of these is incorrect, no response messages are sent, and the device stands by for reception of STX.
- Number of word addresses accessible by a single frame

Type	Description of command	RAM area	EEPROM area
RS	Decimal format read command	16	16
WS	Decimal format write command	16	16
RD	Hexadecimal format read command	28	28
WD	Hexadecimal format write command	27	16
RU	Hexadecimal format random read command	28	28
WU	Hexadecimal format random write command	14	14

● List of data link layer data definitions

The following list shows the definitions for data in the data link layer:

Data name	Character code	Number of characters	Meaning of data
STX	02H	1	Start of message
Station address	0 to 7FH are expressed as hexadecimal character codes.	2	Identification of device to communicate with
Sub-address	"00" (30H, 30H)	2	No function
Device ID code	"X" (58H) or "x" (78H)	1	Device type
ETX	ETX (03H)	1	End position of the application layer
Checksum	00H to FFH are expressed as two-digit hexadecimal character codes.	2	Checksum of message
CR	0DH	1	End of message (1)
LF	0AH	1	End of message (2)

● Description of data items

- STX (02H)

When STX is received, the device judges this to be the start of the send message. For this reason, the device returns to the initial state whatever reception state it was in, and processing is started on the assumption that the STX, the first character, has been received. The purpose of this is to enable recovery of the device's response at the next correct message (e.g. RETRY message) from the master station in the event that noise, for example, causes an error in the sent message.

- Station address

Of the messages sent by the master station, the device creates response messages only when station addresses are the same. Station addresses in messages are expressed as two-digit hexadecimal characters.

The station address is set up by the station address setup (setup setting C65). However, when the station address is set to 0 (30H 30H), the device creates no response even if station addresses match.

The device returns the same station address as that received as the response message.

- Sub-address

The SDC15 does not use the sub-address. For this reason, set "00" (30H 30H). The device returns the same sub-address as that received as the response message.

- Device ID code

The device sets X (58H) or x (78H) as the device ID code. This code is determined for each device series, and other codes cannot be selected. The device returns the same device ID code as that received as the response message. X (58H) is used as the default, and x (78H) is used for judging the message as the resend message.

- ETX

ETX indicates the end of the application layer.

- Checksum

This value is for checking whether or not some abnormality (e.g. noise) causes the message content to change during communications.

The checksum is expressed as two hexadecimal characters.

• How to calculate a checksum

- (1) Add the character codes in the message from STX through ETX in single byte units.
- (2) Take 2's complement of the low-order one byte of the addition result.
- (3) Convert the obtained 2's complement to a two-byte ASCII code.

The following is a sample checksum calculation:

[Sample message]

```

STX: 02H
'0': 30H (first byte of the station address)
'1': 31H (second byte of the station address)
'0': 30H (first byte of the sub-address)
'0': 30H (second byte of the sub-address)
'X': 58H (device ID code)
'R': 52H (first byte of the command)
'S': 53H (second byte of the command)
(omitted)
ETX: 03H
    
```

- (1) Add the character codes in the message from STX through ETX in single byte units.

The add operation in single byte units is as follows:

$$02H + 30H + 31H + 30H + 30H + 58H + 52H + 53H + \dots + 03H.$$

Assume that the result is 376H.

- (2) The low-order one byte of the addition result 376H is 76H. The 2's complement of 76H is 8AH.
- (3) Convert the obtained 8AH to a two-byte ASCII code.

The result is:

'8': 38H

'A': 41H,

and the two bytes, '8'(38H) and 'A'(41H), are the checksum.

• CR/LF

This indicates the end of the message. Immediately after LF is received, the device enters a state allowed to process the received message.

■ Application layer

The table below shows the configuration of the application layer.

Item	Description
Command	"RS" (decimal number format continuous address data read command)
	"WS" (decimal number format continuous address data write command)
	"RD" (hexadecimal number format continuous address data read command)
	"WD" (hexadecimal number format continuous address data write command)
	"RU" (hexadecimal number format random address data read command)
	"WU" (hexadecimal number format random address data write command)
Data delimiter	RS, WS: ", " (comma) Other commands: None
Word address	RS, WS: "501W", etc. Other commands: "01F5", etc.
Read count	Numerical value of characters expressed as "1" for example
Numerical value to be written	RS, WS: Numerical value of characters expressed as "100" for example Other commands: Numerical value of characters expressed in hexadecimal as "0064" for example

7 - 3 Description of Commands

■ Continuous data read command (RS command)

This command reads data of continuous addresses by a single command.

● Send message

This command enables the content of continuous data addresses starting with the specified read start address to be read as a single message. The figure below shows the structure of the application layer of the send message when the data is read.

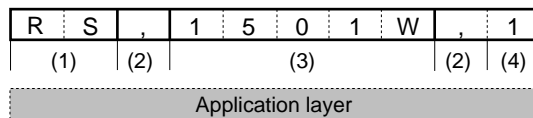

- (1) Continuous read command
- (2) Data delimiter
- (3) Word address
- (4) Read data count

● Response message

If the message is correctly received, a response message corresponding to the command content is returned.

The figure below shows the structure of the application layer of the response message when the data is read.

● Maximum read data count per message

- Normal termination (reading of single data item)

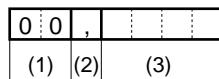

- Normal termination (reading of multiple data items)

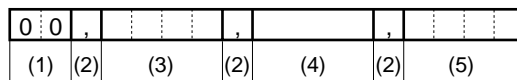

- Abnormal termination



The abnormal termination code is entered at XX.
 For details of codes,
 refer to 7-6, List of Termination Codes (on page 7-14).

- (1) Termination code
- (2) Data delimiter
- (3) Data
- (4) Data 2 to (n-1)
- (5) Data (n)

Up to 16 words for both RAM and EEPROM area

■ Continuous data write command (WS command)

This command writes data to continuous addresses.

● Send message

The figure below shows the structure of the application layer of the send message for the data write command.

W	S	,	1	5	0	1	W	,	1	,	6	5
(1)	(2)		(3)				(2)	(4)	(2)		(5)	

- (1) Write command
- (2) Data delimiter
- (3) Start write word address
- (4) Write data (first word)
- (5) Write data (second word)

● Response message

The figure below shows the structure of the application layer of the response message for the data write command.

- Normal termination

0	0
(1)	

- Abnormal termination or warning

X	X
(1)	

The abnormal termination code is entered at XX.
For details of codes,  refer to 7-6, List of Termination Codes (on page 7-14).

- (1) Termination code

● Maximum read data count per message

Up to 16 words for both RAM and EEPROM areas

■ **Fixed length continuous data read command (RD command)**

This command reads continuous data in two-byte units. This command is suitable for handling data in ladder programs sent by PLC communications as the data is of a fixed length.

The start data address is expressed as four hexadecimal digits. The data count is expressed as four digits, and data is expressed as four X n (n is a positive integer) hexadecimal digits.

● **Send message**

The read start data address (four hexadecimal digits) and the read data count (four hexadecimal digits) are sent.

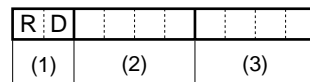

- (1) Fixed length continuous data read command
- (2) Start data word address
- (3) Data count

● **Response message**

If the message is sent successfully, the termination code is taken to be normal (two decimal digits) and returned appended with the read data count (four hexadecimal digits X read data count) specified by the command. If message transmission ends in error, the termination code is taken to be in error (two decimal digits) and returned without the read data appended.

- Normal termination (reading of single data item)

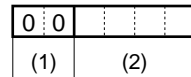

- Normal termination (reading of multiple data items)

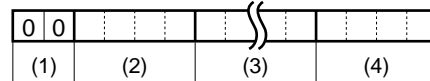

- Abnormal termination



The abnormal termination code is entered at XX.
 For details of codes, refer to 7-6, List of Termination Codes (on page 7-14).

- (1) Termination code
- (2) Data
- (3) Data 2 to (n-1)
- (4) Data (n)

● **Maximum read data count per message**

Up to 28 words for both RAM and EEPROM areas

■ **Fixed length continuous data write command (WD command)**

This command writes continuous data in two-byte units. This command is suitable for handling data in ladder programs sent by PLC communications as the data is of a fixed length.

The start data address is expressed as four hexadecimal digits. Data is expressed as four X n (n is a positive integer) hexadecimal digits.

● **Send message**

The write start data address (four hexadecimal digits) and the write data count (four X n hexadecimal digits) are sent.

- Writing of single data item

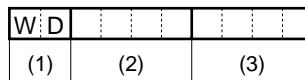

- Writing of multiple data items

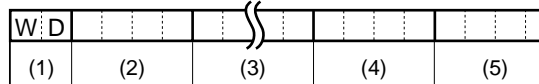

- (1) Fixed length continuous data write command
- (2) Start data word address
- (3) Data 1
- (4) Data 2 to data (n-1)
- (5) Data n

● **Response message**

If writing is successful, the normal termination code (two decimal digits) is returned. If only part of the data is written, and the remaining data is not written, the warning termination code (two decimal digits) is returned. If none of the data is written, the abnormal termination code (two decimal digits) is returned.

- Normal termination



- Abnormal termination or warning



The abnormal termination code is entered at XX.
For details of codes, refer to 7-6, List of Termination Codes (on page 7-14).

- (1) Termination code

● **Maximum read data count per message**

RAM area: Up to 27 words
EEPROM area: Up to 16 words

■ **Fixed length random data read command (RU command)**

This command reads random (non-continuous) data in two-byte units.

● **Send message**

The data address (four hexadecimal digits) of the data to be read is sent in the specified order.

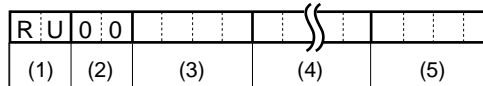

- (1) Fixed length random data write command
- (2) Sub-command: fixed to "00".
- (3) Data address 1
- (4) Data address 2
- (5) Data address (n)

● **Response message**

If the message is sent successfully, the termination code is taken to be normal (two decimal digits) and returned appended with the read data count (four hexadecimal digits X read data count) specified by the command. If message transmission ends in error, the termination code is taken to be in error (two decimal digits) and returned without the read data appended.

• Normal termination

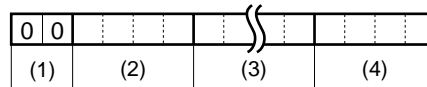

• Abnormal termination

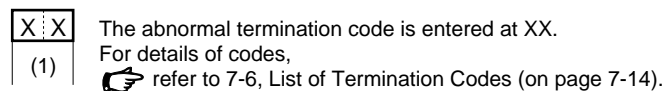

- (1) Termination code
- (2) Data 1
- (3) Data 2 to (n-1)
- (4) Data (n)

● **Maximum read data count per message**

Up to 28 words for both RAM and EEPROM areas

■ Fixed length random data write command (WU command)

This command writes data to random (non-continuous) addresses in two-byte units. Data is expressed as four hexadecimal digits.

● Send message

Data is sent for the specified write data count with the data address (four hexadecimal digits) of the data to be written and the data (four hexadecimal digits) as a pair.

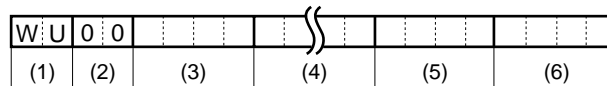

- (1) Fixed length random data write command
- (2) Sub-command: fixed to "00".
- (3) Data address 1
- (4) Write data 1
- (5) Data address (n)
- (6) Write data (n)

● Response message

If writing is successful, the normal termination code (two decimal digits) is returned. If only part of the data is written, and the remaining data is not written, the warning termination code (two decimal digits) is returned. If none of the data is written, the abnormal termination code (two decimal digits) is returned.

• Normal termination



• Abnormal termination or warning



The abnormal termination code is entered at XX.
For details of codes,  refer to 7-6, List of Termination Codes (on page 7-14).

(1) Termination code

● Maximum write data count per message

Up to 14 words for both RAM and EEPROM area

7 - 4 Definition of Word Addresses

- **RAM and EEPROM areas of word addresses**

Word addresses are categorized as follows:

Word address (hexadecimal notation)	Name	Remarks
273W to 14859W (0111 to 3A0B)	RAM access word address	Reading and writing of these addresses are both performed on RAM. Since writing is not performed to EEPROM, the value returns to that stored in EEPROM when the power is turned OFF then ON again.
16657W to 31243W (4111 to 7A0B)	EEPROM access word address	Writing is performed to both RAM and EEPROM; reading is performed only on RAM. Since writing is also performed to EEPROM, the value does not change even when the power is turned OFF then ON again.

Handling Precautions

The number of times that EEPROM can be rewritten is limited (100,000 operations). Accordingly, we recommend writing parameters that are rewritten extremely frequently to RAM that can be infinitely rewritten to. Note, however, that when writing to RAM is performed, the data in EEPROM is transferred to RAM when the power is turned ON again.

- **Write data range**

If the write value exceeds the range determined by parameters, writing is not performed and an abnormal termination code is returned.

- **Write conditions**

An abnormal termination code is also returned when the writing is not possible due to the conditions.

7 - 5 Numeric Representation in the Application Layer

The specifications of numeric representation are decimal variable-length (zero suppress) for RS and WS commands and hexadecimal fixed-length for RD, WD, RU and WU commands. Details are as follows:

● RS and WS commands

Item	Specifications	Remedies
Unwanted space	Cannot be appended.	The message processing is aborted and an abnormal termination code is returned as a response message.
Unwanted zero	Cannot be appended.	
Numerical value = zero	Cannot be omitted. Be sure to use "0".	
Other unwanted characters	Numerical values may be prefixed with a "-" expressing a negative number. Any other character cannot be appended. The "+" sign must not be appended to indicate positive numerical values.	
Range of available numerical values	-32768 to +32767 Values out of this range are not allowed.	

● RD, WD, RU and WU commands

Item	Specifications	Remedy
Unwanted space	Cannot be appended.	The message processing is aborted and an abnormal termination code is returned as a response message.
Unwanted zero	Cannot be appended.	
Numerical value = zero	Cannot be omitted. Be sure to use "0000".	
Other unwanted characters	Cannot be appended.	
Range of available numerical values	0000H to FFFFH	

7 - 6 List of Termination Codes

When an error occurred in the application layer, an abnormal termination code is returned as a response message.

Termination code	Description	Remedies	Example
00	Normal termination	All the processing has normally completed.	
99	Undefined command Other error	Only the termination code is returned but the message processing is not performed.	AA,1001W,1 RX03E80001
10	Conversion error of a numerical value <ul style="list-style-type: none"> • A numerical value of 7 digits or more • A figure other than 0 of which the leading digit is 0 • The conversion result is 65535 or greater, or -65536 or smaller. • Other obvious illegal representation of an integer 	Processing is aborted just when a conversion error or a range error has occurred. (Processing is performed just before an error has occurred.)	RS,1001W,100000 RS,01001W,1 RS,+1001W,1 WS,10?1W,1 RD03E9000> RU0103E9
22	The value of written data is out of the specified range.	Processing is continued excluding the word address in question.	(Example: Specified range for 500W is 0 to 1) (Processing aborted) WS,5001W,3000 WD13890BB8 WU0013890BB8
23	Writing disabled due to instrument set value conditions, instrument external conditions, etc.	Processing is continued excluding the word address in question.	
	Writing/reading disabled because communications/loader locked	Only the termination code is returned but the message processing is not performed.	
40	Read/write word count error	Only the termination code is returned but the message processing is not performed.	RS,1001W,100 RD03E90064
41	Word address out of the range <ul style="list-style-type: none"> • Out of the range between 256 and 65534 	Only the termination code is returned but the message processing is not performed.	RS,100000W,1 RD03G90001 RU00\$3E903EA WS,03E9W,1 WD0XX0001 WU00o3E9001
42	Value of data out of the specified range <ul style="list-style-type: none"> • -32769 or smaller, or 32768 or greater 	Processing is performed up to the word address in question; the succeeding processing is not performed.	WS,2101W,100,XXX WS,2101W,100000 WD03E900010XXX

7 - 7 Reception and Transmission Timing

■ Timing specifications for instruction and response message

The cautions below are required with regard to the timing to transmit an instruction message from the master station and a response message from the slave station.

● Response monitor time

The maximum response time from the end of the instruction message transmission by the master station until when the master station receives a response message from the slave station is two seconds ((1) in the figure below). So, the response monitor time should be set to two seconds.

Generally, when a response time-out occurs, the instruction message is resent.

● Transmission start time

A wait time of 10ms is required before the master station starts to transmit the next instruction message (to the same slave station or a different slave station) after the end of receiving a response message ((2) in the figure below).

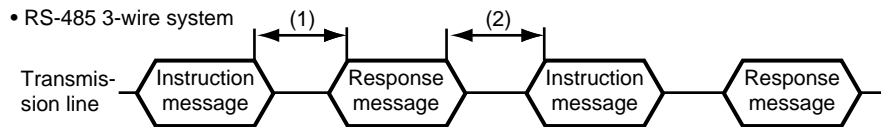

- (1) End of master station transmission -
Transmission start time of slave station = Max. 2000ms
- (2) End of slave station transmission -
Transmission start time of master station = Min. 10ms

■ RS-485 driver control timing specifications

When the transmission/reception on the RS-485 3-wire system is directly controlled by the master station, care should be paid to the following timing:

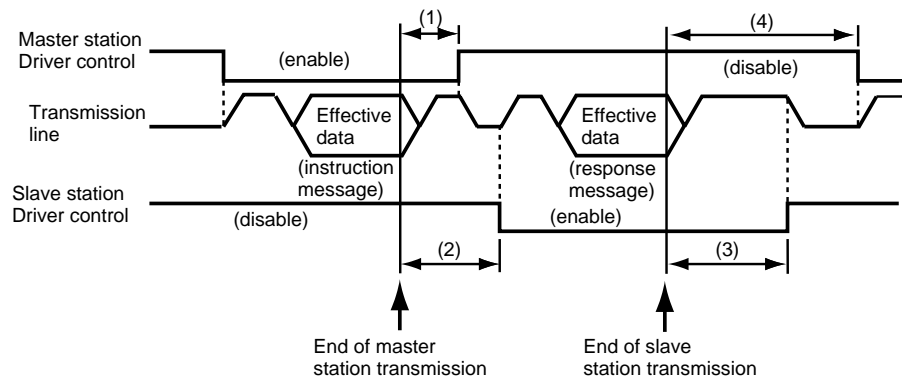

- (1) End of master station transmission - Driver disable time = Max. 500 s
- (2) End of slave station reception - Driver enable time = Response time-out Setup setting (C70) or greater
- (3) End of slave station transmission - Driver disable time = Max. 10ms
- (4) End of master station reception - Driver enable time = Min. 10ms

7 - 8 Cautions when Making Communications Programs for the Master Station

Pay attention to the following points when making communications programs:

- The longest response time on the device is two seconds. For this reason, set the response monitor time to two seconds.
- Resend the same message if there is no response within two seconds. Set a communications error to occur if there is no response even after two retries.
- Be sure to make the above resends to guard against the case when the message cannot be send correctly due to the influence of noise, for example, during communications.



Note

When the master station resends the message, alternatively use the device ID codes "X" and "x." This is convenient as you can tell whether or not the received message is the previously received message.

■ Example of communications program

A sample program is installed in the folder in which the smart loader package SLP-C35 has been installed.

In the default setting, the directory is "c:\program files\slp\slpc35\cpl.cpp".

The program is written in Borland's C++Builder5.0 or Borland C++Compiler5.5 for Windows95/98/NT/2000.

This program is given here as a reference when the user makes a program, and does not assure all the operations.

You can download Borland C++Compiler5.5 from Borland Home Page.



Handling Precautions

Yamatake assumes no responsibility with regard to any trouble caused by using this program.

● Prior to running the sample program

Make sure to check the settings for communications type, station address, transmission speed and data format of the instrument.

● Running the sample program

This program is used for reading and writing data. When the program is executed, the application layers of the instruction message and response message communicated are indicated.

```
command:RS,14356W,2
result:00,0,0
command:WS,14357W,2
result:00
```

Sample indication of execution results

● Processing of the sample program

- Communication settings
Call open() and initialize the RS-232C serial port.
- Command execution
Set a desired character string in 'command' and call AppCPL().

Chapter 8. MODBUS COMMUNICATIONS FUNCTIONS

8 - 1 Outline of Communications

If the optional model number is provided with the RS-485 communications function, communications with a PC, PLC or other host devices are available using a user-prepared program.

The communications protocol can be selected from the CPL communications (Controller Peripheral Link: Yamatake's host communications protocol) and the MODBUS communications. This chapter describes the MODBUS communications.

■ Features

The features of the SDC15's communications functions are as follows:

- Up to 31 SDC15 units can be connected to a single master station as a host device.
- When the communications specifications of the host device conform to the RS-232C interface, the communications converter CMC10L (sold separately) is required.

The CMC10L allows you to perform the conversion between RS-232C and RS-485.

- Almost all of the parameters held by the device can be communicated.

For details on communications parameters,

☞ refer to Chapter 9, LIST OF COMMUNICATION DATA.

■ Setup

The following setups are required for performing the MODBUS communications:

Item (Setting display/bank)	Display	Contents	Initial value	User level
CPL/MODBUS (Setup setting/Setup bank)	Ⓒ 54	0: CPL 1: MODBUS ASCII format 2: MODBUS RTU format	0	Simple, Standard, High function
Station address (Same as above)	Ⓒ 55	0: Does not communicate 1 to 127	0	
Transmission speed (Same as above)	Ⓒ 56	0: 4800bps 1: 9600bps 2: 19200bps 3: 38400bps	2	
Data format (Data length) (Same as above)	Ⓒ 57	0: 7-bit 1: 8-bit	1	
Data format (Parity) (Same as above)	Ⓒ 58	0: Even parity 1: Odd parity 2: No parity	0	
Data format (Stop bit) (Same as above)	Ⓒ 59	0: 1 stop bit 1: 2 stop bits	0	
Response time-out	Ⓒ 70	1 to 250 ms	3	High function

- If the optional model number is provided with the RS-485 communications function, display and setup are available.
- If the communications type is set to MODBUS RTU format, data format (data length) cannot be displayed nor set up, and the action is fixed to 8-bit data.

⚠ Handling Precautions

- Setups can be performed through key operation on the console or the smart loader package SLP-C35. However, they cannot be performed via RS-485 communications.
- If you use the Yamatake CMC10L as an RS-232C/RS-485 converter, set the response time-out (C70) to 3 ms or longer.

■ Communications procedures

The communications procedure is as follows:

- (1) The instruction message is sent from the host device (master station) to one SDC15 unit (slave station) to communicate with.
- (2) The slave station receives the instruction message, and performs read or write processing according to the content of the message.
- (3) The slave station sends a message corresponding to the processing content as a response message.
- (4) The master station receives the response message.

❗ Handling Precautions

It is not allowed to use two or more number of protocols together on one and the same RS-485 transmission line such as CPL, MODBUS ASCII format, and MODBUS RTU format.

8 - 2 Message Structure

■ Message structure

This section describes the message structure.
All messages are expressed in hexadecimal.

● MODBUS ASCII

All messages other than delimiters are written in hexadecimal ASCII codes.
A message of MODBUS ASCII consists of (1) to (6) below.

The application layer stores commands, which are transmission contents from the master station and responses, which are transmission contents from the slave station.

All messages use ASCII codes (Each slot below corresponds to one character.)

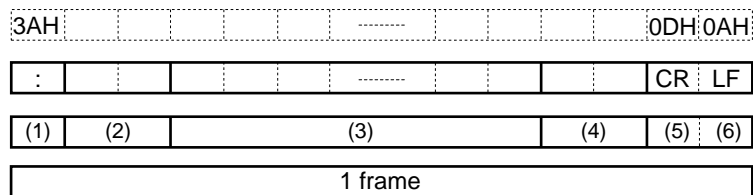

- (1) Start of message (colon, expressed with ASCII code 3AH)
- (2) Station address (2 bytes)
- (3) Send message, response message
- (4) Checksum (two-byte LRC)
- (5) CR (delimiter)
- (6) LF (delimiter)

• Colon (3AH)

When a colon (3AH) is received, the device judges this to be the start of the send message. For this reason, the device returns to the initial state whatever reception state it was in, and processing is started on the assumption that the colon (3AH), the first character, has been received. The purpose of this is to enable recovery of the device's response at the next correct message (e.g. RETRY message) from the master station in the event that noise, for example, causes an error in the sent message.

• Station address

Of the messages sent by the master station, the device creates response messages only when station addresses are the same. Station addresses in messages are expressed as two hexadecimal characters. The station address is set up by the station address setup (setup setting C65). However, when the station address is set to 0 (30H 30H), the device creates no response even if station addresses match. The device returns the same station address as that received as the response message.

• Checksum (LRC)

This value is for checking whether or not some abnormality (e.g. noise) causes the message content to change during communications. The checksum is expressed as two hexadecimal characters. The method to calculate a checksum is as follows:

- (1) Add the data from the top up to just before the checksum. Note that the values to be added are not the ASCII character values in the send message but the one-byte binary data converted from two ASCII characters.

- (2) Take 2's complement of the addition result.
- (3) Convert the low-order one byte of the addition result to a character code.

The following is a sample checksum calculation:

[Sample message]

: : 3AH (start of the message)
'0' : 30H (first byte of the station address)
'A' : 41H (second byte of the station address)
'0' : 30H (first byte of the read command)
'3' : 33H (second byte of the read command)
'0' : 30H (first byte of the start word address)
'3' : 33H (second byte of the start word address)
'E' : 45H (third byte of the start word address)
'9' : 39H (fourth byte of the start word address)
'0' : 30H (first byte of the read count)
'0' : 30H (second byte of the read count)
'0' : 30H (third byte of the read count)
'2' : 32H (fourth byte of the read count)

- (1) Add the data from the top up to just before the checksum.

The add operation is as follows:

0AH + 03H + 03H + E9H + 00H + 02H

The result is FBH.

- (2) The low-order byte of the addition result FBH is FBH as is. The 2's complement of FBH is 05H.

- (3) Convert the obtained 05H to a two-byte ASCII code.

The result is:

'0' : 30H

'5' : 35H,

and the two bytes, '0' (30H) and '5' (35H), are the checksum.

- **CR/LF**

This indicates the end of the message. Immediately after LF is received, the device immediately stands by for permission to process the received message.

● MODBUS RTU

All messages are written in binary data.

A MODBUS RTU message consists of (1) to (3) below.

The application layer stores commands, which are transmission contents from the master station and responses, which are transmission contents from the slave station.

All messages use binary data. (Each slot below corresponds to one character.)

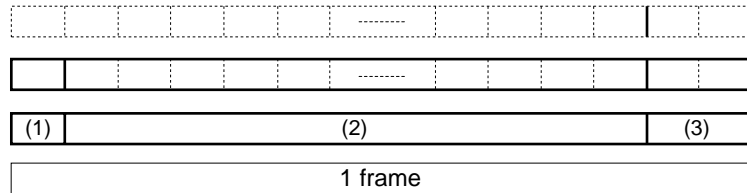

- (1) Station address (1 byte)
- (2) Send message, response message
- (3) Checksum (2 bytes)

- Station address

Of the messages sent by the master station, the device creates response messages only when station addresses are the same. Station addresses in messages are expressed in one byte. The station address is set up by the station address setup (setup setting C65). However, when the station address is set to 0, the device creates no response even if station addresses match. The device returns the same station address as that received as the response message.

- Checksum (CRC)

This value is for checking whether or not some abnormality (e.g. noise) causes the message content to change during communications. The checksum is expressed as 2 bytes.

The checksum (CRC) creation method is shown below.

```

/* CRC calculation */
/* Input   unsigned char length : Number of transmission bytes */
/*        unsigned char *top   : Transmission data start pointer */
/* Output  unsigned short CRC   : CRC calculation result          */
unsigned short crc16( unsigned char length, unsigned char *top )
{
    unsigned short CRC= 0xffff;
    unsigned short next;
    unsigned short carry;
    unsigned short n;
    unsigned char  crcl;

    while ( length-- ) {
        next = (unsigned short)*top;
        CRC ^= next;
        for ( n = 0; n < 8; n++ ) {
            carry = CRC & 1;
            CRC >>= 1;
            if (carry) {
                CRC ^= 0xA001;
            }
        }
        top++;
    }

    crcl = (CRC & 0xff00)>>8;
    CRC <<= 8;
    CRC |= crcl;

    return CRC;
}

```

- 1-frame end judgment

A message end (1-frame end) is determined when a time period specified for each transmission speed has passed during which no character is received. It is considered that 1 frame has ended when the next character is not received before the time-out time shown below passes.

However, the time-out time has a fluctuation of ± 1 ms from the values in the table below.

Set transmission speed (bps)	Time-out time
4800	16ms or more
9600	8ms or more
19200	4ms or more
38400	2ms or more

■ Command type

There are two command (send message) types as shown below:

Command	Description	
	ASCII	RTU (binary)
Read command	"03" (sample)	03H (sample)
Write command	"10" (sample)	10H (sample)

■ Other specifications

- Supporting the MODBUS Class 0
- Abnormal termination codes

Code	Description
01	Command error
02	Address error
03	Data error

- Maximum number of communications data words

Data count	ASCII	RTU
03 (READ)	16	16
16 (WRITE)	16	16

- Other

For the details of MODBUS specifications,



refer to OPEN MODBUS/TCP SPECIFICATION (Release 1.0) by Modicon Inc.

8 - 3 Description of Commands

■ Read command (03H)

● Send Message

This is a command capable of reading the contents of continuous data addresses from a specified read start data address with a single message. The following is an example of send message while reading data:

MODBUS ASCII

3AH	30H	41H	30H	33H	30H	33H	45H	39H	30H	30H	30H	32H	30H	35H	0DH	0AH
:	0	A	0	3	0	3	E	9	0	0	0	2	0	5	CR	LF
(1)	(2)	(3)	(4)				(5)			(6)		(7)				

- (1) Start of message
- (2) Station address
- (3) Read command
- (4) Start word address
- (5) Read count
- (6) Checksum (LRC)
- (7) Delimiter

MODBUS RTU

0AH	03H	03H	E9H	00H	02H	14H	C0H
(1)	(2)	(3)	(4)	(5)			

- (1) Station address
- (2) Read command
- (3) Start word address
- (4) Read count
- (5) Checksum (CRC)

● Response Message

A response message corresponding to the command content is returned when the message is correctly received.

The figure below shows the structure of the response message while reading data.

MODBUS ASCII

3AH	30H	41H	30H	33H	30H	34H	30H	33H	30H	31H	30H	30H	30H	33H	45H	38H	D0H	0AH
:	0	A	0	3	0	4	0	3	0	1	0	0	0	3	E	8	CR	LF
(1)	(2)	(3)	(4)	(5)				(6)			(7)		(8)					

• Example in case of normal reception

- (1) Start of message
- (2) Station address
- (3) Read command
- (4) Data count X 2
- (5) Read data 1
- (6) Read data 2
- (7) Checksum (LRC)
- (8) Delimiter

• Example in case of error

3AH	30H	41H	38H	34H	30H	31H	37H	31H	0DH	0AH
:	0	A	8	4	0	1	7	1	CR	LF
(1)	(2)	(3)	(4)	(5)	(6)					

- (1) Start of message
- (2) Station address
- (3) Error flag (since undefined "04" is sent as a command with a send message, the most significant bit is turned ON and sent back as "84".)
- (4) Abnormal termination code (☞ refer to page 8-6)
- (5) Checksum (LRC)
- (6) Delimiter

MODBUS RTU

• Example in case of normal reception

0AH	03H	04H	03H	01H	00H	03H	51H	76H
(1)	(2)	(3)	(4)	(5)	(6)			

- (1) Station address
- (2) Read command
- (3) Read count X 2 (bytes)
- (4) Read data 1
- (5) Read data 2
- (6) Checksum (CRC)

• Example in case of error

0AH	84H	01H	F3H	02H
(1)	(2)	(3)	(4)	

- (1) Station address
- (2) Error flag (since undefined "04H" is sent as a command with a send message, the most significant bit is turned ON and sent back as "84H".)
- (3) Abnormal termination code (☞ refer to page 8-6)
- (4) Checksum (CRC)

■ Write command (10H)

● Send Message

This is a command capable of writing the contents of continuous data addresses from a specified write start data address with a single message. The following is an example of send message while writing data:

(Example) Writing 01A0H and 0E53H in the continuous data addresses consisting of 2 words following 1501W (05DDH).

3AH	30H	31H	31H	30H	30H	35H	44H	44H	30H	30H	30H	32H	30H	34H
:	0	1	1	0	0	5	D	D	0	0	0	2	0	4
(1)	(2)	(3)	(4)		(5)			(6)						

30H	31H	41H	30H	30H	45H	35H	33H	30H	35H	0DH	0AH
0	1	A	0	0	E	5	3	0	5	CR	LF
(7)			(8)		(9)		(10)		(11)		

MODBUS ASCII

- (1) Start of message
- (2) Station address
- (3) Write command 10H
- (4) Write start word address 1
- (5) Write data count
- (6) Write data count X 2
- (7) Write data 1
- (8) Write data 2
- (9) Checksum
- (10) CR
- (11) LF

01H	10H	05H	DDH	00H	02H	04H	01H	A0H	0EH	53H	45H	B9H
(1)	(2)	(3)	(4)	(5)	(6)	(7)	(8)					

MODBUS RTU

- (1) Station address
- (2) Write command 10H
- (3) Write start word address 1
- (4) Write data count
- (5) Write data count x 2
- (6) Write data 1
- (7) Write data 2
- (8) Checksum

● **Response Message**

A response message corresponding to the command content is returned when the message is correctly received.

The figure below shows the structure of the response message when the data is written.

MODBUS ASCII

3AH	30H	31H	31H	30H	30H	35H	44H	44H	30H	30H	30H	32H	30H	42H	0DH	0AH
:	0	1	1	0	0	5	D	D	0	0	0	2	0	B	CR	LF
(1)	(2)	(3)	(4)				(5)			(6)	(7)	(8)				

- (1) Start of message
- (2) Station address
- (3) Write command 10H
- (4) Write start word address 1
- (5) Write data count
- (6) Checksum
- (7) CR
- (8) LF

MODBUS RTU

01H	10H	05H	DDH	00H	02H	D1H	3EH
(1)	(2)	(3)	(4)	(5)			

- (1) Station address
- (2) Write command 10H
- (3) Write start word address
- (4) Write data count
- (5) Checksum

 **Note**

The response message at the time of abnormal termination is the same as that for the read command.

8 - 4 Specifications Common with CPL Communications Function

■ Definition of word addresses

☞ Refer to 7-4 Definition of Word Addresses (on page 7-12)

■ Numeric representation

The specifications of numeric representation is the same as the following:

☞ ● RD, WD, RU and WU commands in 7-5 Numeric Representation in the Application Layer (on page 7-13).

■ RS-485 driver control timing specifications

☞ Refer to 7-7 Reception and Transmission Timing (on page 7-15).

Chapter 9. LIST OF COMMUNICATION DATA

■ List of communication data

The following shows the meanings of the symbols stated in the “RAM/EEPROM Read/Write” columns:

- No symbol: Possible.
- *: Possible according to the conditions.
- Δ: Possible, but data is invalid.
- X: Impossible.

Note: When reading the EEPROM address, data in the RAM is read in the same manner as reading of the RAM address.

- Decimal point information: No decimal point
- 1 to 3: Decimal point position (The communication data becomes that the original value is multiplied by 10, 100, or 1000.)
- P: Follows the PV input range.
- S: Follows various conditions.

RS/WS commands of CPL communication

Decimal data address with “W” attached next to it is used.

RD/WD/RU/WU commands of CPL communication: Hexadecimal data address is used.

Commands of MODBUS communication:

Hexadecimal data address is used.

Bank	Item name	RAM address		EEPROM address		RAM		EEPROM		Decimal point information	Remarks
		Decimal	Hexadecimal	Decimal	Hexadecimal	Read	Write	Read	Write		
Instrument information	ROM ID	273	0111	16657	4111		X		X	—	"0" when using SDC15.
	ROM Version 1	274	0112	16658	4112		X		X	2	
	ROM Version 2	275	0113	16659	4113		X		X	2	
	LOADER Information	276	0114	16660	4114		X		X	—	
	EST Information	277	0115	16661	4115		X		X	—	
	Manufacturing date code (year)	278	0116	16662	4116		X		X	—	Christian year - 200 Example: Year of 2003 is expressed as "3"
	Manufacturing date code (month, day)	279	0117	16663	4117		X		X	2	Month + (Day ÷ 100) Example: Dec. 1st is expressed as "12.01".
	Serial No.	280	0118	16664	4118		X		X	—	
Lock	Key lock	5001	1389	21385	5389					—	
	Communication lock	5002	138A	21386	538A	*	X	*	X	—	When the communication lock exists, the error response is sent.
	Loader lock	5003	138B	21387	538B		X		X	—	
	Password display	5004	138C	21388	538C				X	—	
	Password 1A	—	—	—	—	X	X	X	X	—	Communication and loader cannot read and write the password.
	Password 2A	—	—	—	—	X	X	X	X	—	Same as above.
	Password 1B	—	—	—	—	X	X	X	X	—	Same as above.
	Password 2B	—	—	—	—	X	X	X	X	—	Same as above.
User Function	User Function 1	5101	13ED	21485	53ED					—	
	User Function 2	5102	13EE	21486	53EE					—	
	User Function 3	5103	13EF	21487	53EF					—	
	User Function 4	5104	13F0	21488	53F0					—	
	User Function 5	5105	13F1	21489	53F1					—	
	User Function 6	5106	13F2	21490	53F2					—	
	User Function 7	5107	13F3	21491	53F3					—	
	User Function 8	5108	13F4	21492	53F4					—	
Setup	PV input range type	5201	1451	21585	5451					—	
	Temperature unit	5202	1452	21586	5452		*		*	—	
	Cold junction compensation (T/C)	5203	1453	21587	5453		*		*	—	
	Decimal point position	5204	1454	21588	5454		*		*	—	

Chapter 9. LIST OF COMMUNICATION DATA

Bank	Item name	RAM address		EEPROM address		RAM		EEPROM		Decimal point information	Remarks
		Decimal	Hexadecimal	Decimal	Hexadecimal	Read	Write	Read	Write		
Setup	PV input range low limit	5205	1455	21589	5455		*		*	P	
	PV input range high limit	5206	1456	21590	5456		*		*	P	
	SP low limit	5207	1457	21591	5457					P	
	SP high limit	5208	1458	21592	5458					P	
	PV square root extraction dropout	5209	1459	21593	5459		*		*	1	
	(Reserved for future extension.)	5210	145A	21594	545A	Δ	X	Δ	X	—	
	(Reserved for future extension.)	5211	145B	21595	545B	Δ	X	Δ	X	P	
	(Reserved for future extension.)	5212	145C	21596	545C	Δ	X	Δ	X	P	
	(Reserved for future extension.)	5213	145D	21597	545D	Δ	X	Δ	X	—	
	Control action (Direct/Reverse)	5214	145E	21598	545E					—	
	Output operation at PV alarm	5215	145F	21599	545F					—	
	Output at PV alarm	5216	1460	21600	5460					1	
	Output at READY (Heat)	5217	1461	21601	5461					1	
	Output at READY (Cool)	5218	1462	21602	5462					1	
	Output operation at changing Auto/Manual	5219	1463	21603	5463					—	
	Preset MANUAL value	5220	1464	21604	5464					1	
	Initial output type (mode) of PID control	5221	1465	21605	5465					—	
	Initial output of PID control	5222	1466	21606	5466					1	
	(Reserved for future extension.)	5223	1467	21607	5467	Δ	X	Δ	X	—	
	(Reserved for future extension.)	5224	1468	21608	5468	Δ	X	Δ	X	—	
	(Reserved for future extension.)	5225	1469	21609	5469	Δ	X	Δ	X	—	
	Heat/Cool control	5226	146A	21610	546A					—	
	Heat/Cool selection	5227	146B	21611	546B					—	
	Heat/Cool control dead zone	5228	146C	21612	546C					1	
	Heat/Cool control change point	5229	146D	21613	546D					1	
	LSP system group	5230	146E	21614	546E					—	
	(Reserved for future extension.)	5231	146F	21615	546F	Δ	X	Δ	X	—	
	SP ramp unit	5232	1470	21616	5470					—	
	(Reserved for future extension.)	5233	1471	21617	5471	Δ	X	Δ	X	—	
	(Reserved for future extension.)	5234	1472	21618	5472	Δ	X	Δ	X	—	
	(Reserved for future extension.)	5235	1473	21619	5473	Δ	X	Δ	X	—	
	CT1 operation type	5236	1474	21620	5474					—	
	CT1 output	5237	1475	21621	5475					—	
	CT1 measurement wait time	5238	1476	21622	5476					—	
	CT2 operation type	5239	1477	21623	5477					—	
	CT2 output	5240	1478	21624	5478					—	
	CT2 measurement wait time	5241	1479	21625	5479					—	
	Control output 1 range	5242	147A	21626	547A					—	
	Control output 1 type	5243	147B	21627	547B					—	
	Control output 1 scaling low limit	5244	147C	21628	547C					S	
	Control output 1 scaling high limit	5245	147D	21629	547D					S	
	(Reserved for future extension.)	5246	147E	21630	547E	Δ	X	Δ	X	—	
	Control output 2 range	5247	147F	21631	547F					—	
	Control output 2 type	5248	1480	21632	5480					—	
	Control output 2 scaling low limit	5249	1481	21633	5481					S	
	Control output 2 scaling high limit	5250	1482	21634	5482					S	
	(Reserved for future extension.)	5251	1483	21635	5483	Δ	X	Δ	X	—	
	(Reserved for future extension.)	5252	1484	21636	5484	Δ	X	Δ	X	—	
	(Reserved for future extension.)	5253	1485	21637	5485	Δ	X	Δ	X	—	

Bank	Item name	RAM address		EEPROM address		RAM		EEPROM		Decimal point information	Remarks
		Decimal	Hexadecimal	Decimal	Hexadecimal	Read	Write	Read	Write		
Setup	(Reserved for future extension.)	5254	1486	21638	5486	Δ	X	Δ	X	S	
	(Reserved for future extension.)	5255	1487	21639	5487	Δ	X	Δ	X	S	
	(Reserved for future extension.)	5256	1488	21640	5488	Δ	X	Δ	X	—	
	(Reserved for future extension.)	5257	1489	21641	5489	Δ	X	Δ	X	—	
	(Reserved for future extension.)	5258	148A	21642	548A	Δ	X	Δ	X	1	
	(Reserved for future extension.)	5259	148B	21643	548B	Δ	X	Δ	X	—	
	(Reserved for future extension.)	5260	148C	21644	548C	Δ	X	Δ	X	—	
	(Reserved for future extension.)	5261	148D	21645	548D	Δ	X	Δ	X	—	
	(Reserved for future extension.)	5262	148E	21646	548E	Δ	X	Δ	X	—	
	(Reserved for future extension.)	5263	148F	21647	548F	Δ	X	Δ	X	1	
	CPL/MODBUS	5264	1490	21648	5490		X		X	—	
	Station address	5265	1491	21649	5491		X		X	—	
	Transmission speed	5266	1492	21650	5492		X		X	—	
	Data format (Data length)	5267	1493	21651	5493		X		X	—	
	Data format (Parity)	5268	1494	21652	5494		X		X	—	
	Data format (Stop bit)	5269	1495	21653	5495		X		X	—	
	Response time-out	5270	1496	21654	5496		X		X	—	
	Key operation type	5271	1497	21655	5497					—	
	[mode] key function	5272	1498	21656	5498					—	
	MODE display setup	5273	1499	21657	5499					—	
	PV/SP display setup	5274	149A	21658	549A					—	
	MV display setup	5275	149B	21659	549B					—	
	EV display setup	5276	149C	21660	549C					—	
	Timer remain time display setup	5277	149D	21661	549D					—	
	CT display setup	5278	149E	21662	549E					—	
	User level	5279	149F	21663	549F					—	
	Communication monitor display	5280	14A0	21664	54A0					—	
	(Reserved for future extension.)	5281	14A1	21665	54A1	Δ	Δ	Δ	Δ	—	
	(Reserved for future extension.)	5282	14A2	21666	54A2	Δ	Δ	Δ	Δ	—	
	(Reserved for future extension.)	5283	14A3	21667	54A3	Δ	Δ	Δ	Δ	—	
(Reserved for future extension.)	5284	14A4	21668	54A4	Δ	Δ	Δ	Δ	—		
(Reserved for future extension.)	5285	14A5	21669	54A5	Δ	Δ	Δ	Δ	—		
(Reserved for future extension.)	5286	14A6	21670	54A6	Δ	Δ	Δ	Δ	—		
(Reserved for future extension.)	5287	14A7	21671	54A7	Δ	Δ	Δ	Δ	—		
(Reserved for future extension.)	5288	14A8	21672	54A8	Δ	Δ	Δ	X	—		
(Reserved for future extension.)	5289	14A9	21673	54A9	Δ	X	Δ	X	—		
DI Assignment	Internal Contact 1 Operation type	5401	1519	21785	5519					—	
	Internal Contact 1 Input bit function	5402	151A	21786	551A					—	
	Internal Contact 1 Input assign A	5403	151B	21787	551B					—	
	Internal Contact 1 Input assign B	5404	151C	21788	551C					—	
	Internal Contact 1 Input assign C	5405	151D	21789	551D					—	
	Internal Contact 1 Input assign D	5406	151E	21790	551E					—	
	Internal Contact 1 Polarity A	5407	151F	21791	551F					—	
	Internal Contact 1 Polarity B	5408	1520	21792	5520					—	
	Internal Contact 1 Polarity C	5409	1521	21793	5521					—	
	Internal Contact 1 Polarity D	5410	1522	21794	5522					—	
	Internal Contact 1 Polarity	5411	1523	21795	5523					—	
	Internal Contact 1 Event channel def.	5412	1524	21796	5524					—	
	Internal Contact 2 Operation type	5413	1525	21797	5525					—	
	Internal Contact 2 Input bit function	5414	1526	21798	5526					—	

Chapter 9. LIST OF COMMUNICATION DATA

Bank	Item name	RAM address		EEPROM address		RAM		EEPROM		Decimal point information	Remarks
		Decimal	Hexadecimal	Decimal	Hexadecimal	Read	Write	Read	Write		
DI Assignment	Internal Contact 2 Input assign A	5415	1527	21799	5527					—	
	Internal Contact 2 Input assign B	5416	1528	21800	5528					—	
	Internal Contact 2 Input assign C	5417	1529	21801	5529					—	
	Internal Contact 2 Input assign D	5418	152A	21802	552A					—	
	Internal Contact 2 Polarity A	5419	152B	21803	552B					—	
	Internal Contact 2 Polarity B	5420	152C	21804	552C					—	
	Internal Contact 2 Polarity C	5421	152D	21805	552D					—	
	Internal Contact 2 Polarity D	5422	152E	21806	552E					—	
	Internal Contact 2 Polarity	5423	152F	21807	552F					—	
	Internal Contact 2 Event channel def.	5424	1530	21808	5530					—	
	Internal Contact 3 Operation type	5425	1531	21809	5531					—	
	Internal Contact 3 Input bit function	5426	1532	21810	5532					—	
	Internal Contact 3 Input assign A	5427	1533	21811	5533					—	
	Internal Contact 3 Input assign B	5428	1534	21812	5534					—	
	Internal Contact 3 Input assign C	5429	1535	21813	5535					—	
	Internal Contact 3 Input assign D	5430	1536	21814	5536					—	
	Internal Contact 3 Polarity A	5431	1537	21815	5537					—	
	Internal Contact 3 Polarity B	5432	1538	21816	5538					—	
	Internal Contact 3 Polarity C	5433	1539	21817	5539					—	
	Internal Contact 3 Polarity D	5434	153A	21818	553A					—	
Internal Contact 3 Polarity	5435	153B	21819	553B					—		
Internal Contact 3 Event channel def.	5436	153C	21820	553C					—		
DO Assignment	Control output 1 Operation type	5601	15E1	21985	55E1					—	
	Control output 1 Output assign A	5602	15E2	21986	55E2					—	
	Control output 1 Output assign B	5603	15E3	21987	55E3					—	
	Control output 1 Output assign C	5604	15E4	21988	55E4					—	
	Control output 1 Output assign D	5605	15E5	21989	55E5					—	
	Control output 1 Polarity A	5606	15E6	21990	55E6					—	
	Control output 1 Polarity B	5607	15E7	21991	55E7					—	
	Control output 1 Polarity C	5608	15E8	21992	55E8					—	
	Control output 1 Polarity D	5609	15E9	21993	55E9					—	
	Control output 1 Polarity	5610	15EA	21994	55EA					—	
	Control output 1 Latch	5611	15EB	21995	55EB					—	
	Control output 2 Operation type	5612	15EC	21996	55EC					—	
	Control output 2 Output assign A	5613	15ED	21997	55ED					—	
	Control output 2 Output assign B	5614	15EE	21998	55EE					—	
	Control output 2 Output assign C	5615	15EF	21999	55EF					—	
	Control output 2 Output assign D	5616	15F0	22000	55F0					—	
	Control output 2 Polarity A	5617	15F1	22001	55F1					—	
	Control output 2 Polarity B	5618	15F2	22002	55F2					—	
	Control output 2 Polarity C	5619	15F3	22003	55F3					—	
	Control output 2 Polarity D	5620	15F4	22004	55F4					—	
	Control output 2 Polarity	5621	15F5	22005	55F5					—	
	Control output 2 Latch	5622	15F6	22006	55F6					—	
	Event output 1 Operation type	5623	15F7	22007	55F7					—	
	Event output 1 Output assign A	5624	15F8	22008	55F8					—	
Event output 1 Output assign B	5625	15F9	22009	55F9					—		
Event output 1 Output assign C	5626	15FA	22010	55FA					—		
Event output 1 Output assign D	5627	15FB	22011	55FB					—		

Bank	Item name	RAM address		EEPROM address		RAM		EEPROM		Decimal point information	Remarks
		Decimal	Hexadecimal	Decimal	Hexadecimal	Read	Write	Read	Write		
DO Assignment	Event output 1 Polarity A	5628	15FC	22012	55FC					—	
	Event output 1 Polarity B	5629	15FD	22013	55FD					—	
	Event output 1 Polarity C	5630	15FE	22014	55FE					—	
	Event output 1 Polarity D	5631	15FF	22015	55FF					—	
	Event output 1 Polarity	5632	1600	22016	5600					—	
	Event output 1 Latch	5633	1601	22017	5601					—	
	Event output 2 Operation type	5634	1602	22018	5602					—	
	Event output 2 Output assign A	5635	1603	22019	5603					—	
	Event output 2 Output assign B	5636	1604	22020	5604					—	
	Event output 2 Output assign C	5637	1605	22021	5605					—	
	Event output 2 Output assign D	5638	1606	22022	5606					—	
	Event output 2 Polarity A	5639	1607	22023	5607					—	
	Event output 2 Polarity B	5640	1608	22024	5608					—	
	Event output 2 Polarity C	5641	1609	22025	5609					—	
	Event output 2 Polarity D	5642	160A	22026	560A					—	
	Event output 2 Polarity	5643	160B	22027	560B					—	
	Event output 2 Latch	5644	160C	22028	560C					—	
	Event output 3 Operation type	5645	160D	22029	560D					—	
	Event output 3 Output assign A	5646	160E	22030	560E					—	
	Event output 3 Output assign B	5647	160F	22031	560F					—	
	Event output 3 Output assign C	5648	1610	22032	5610					—	
	Event output 3 Output assign D	5649	1611	22033	5611					—	
	Event output 3 Polarity A	5650	1612	22034	5612					—	
	Event output 3 Polarity B	5651	1613	22035	5613					—	
	Event output 3 Polarity C	5652	1614	22036	5614					—	
	Event output 3 Polarity D	5653	1615	22037	5615					—	
	Event output 3 Polarity	5654	1616	22038	5616					—	
	Event output 3 Latch	5655	1617	22039	5617					—	
Event Configuration	Internal Event 1 Operation type	5801	16A9	22185	56A9					—	
	Internal Event 1 Direct/Reverse	5802	16AA	22186	56AA					—	
	Internal Event 1 Standby	5803	16AB	22187	56AB					—	
	Internal Event 1 state at READY	5804	16AC	22188	56AC					—	
	(Reserved for future extension.)	5805	16AD	22189	56AD	Δ	Δ	Δ	Δ	—	
	Internal Event 1 Controller alarm OR	5806	16AE	22190	56AE					—	
	Internal Event 1 Special OFF setup	5807	16AF	22191	56AF					—	
	Internal Event 1 Delay unit	5808	16B0	22192	56B0					—	
	(Reserved for future extension.)	5809	16B1	22193	56B1	Δ	Δ	Δ	Δ	—	
	Internal Event 2 Operation type	5810	16B2	22194	56B2					—	
	Internal Event 2 Direct/Reverse	5811	16B3	22195	56B3					—	
	Internal Event 2 Standby	5812	16B4	22196	56B4					—	
	Internal Event 2 state at READY	5813	16B5	22197	56B5					—	
	(Reserved for future extension.)	5814	16B6	22198	56B6	Δ	Δ	Δ	Δ	—	
	Internal Event 2 Controller alarm OR	5815	16B7	22199	56B7					—	
	Internal Event 2 Special OFF setup	5816	16B8	22200	56B8					—	
	Internal Event 2 Delay unit	5817	16B9	22201	56B9					—	
	(Reserved for future extension.)	5818	16BA	22202	56BA	Δ	Δ	Δ	Δ	—	
	Internal Event 3 Operation type	5819	16BB	22203	56BB					—	
	Internal Event 3 Direct/Reverse	5820	16BC	22204	56BC					—	
Internal Event 3 Standby	5821	16BD	22205	56BD					—		
Internal Event 3 state at READY	5822	16BE	22206	56BE					—		

Chapter 9. LIST OF COMMUNICATION DATA

Bank	Item name	RAM address		EEPROM address		RAM		EEPROM		Decimal point information	Remarks
		Decimal	Hexadecimal	Decimal	Hexadecimal	Read	Write	Read	Write		
Event Configuration	(Reserved for future extension.)	5823	16BF	22207	56BF	Δ	Δ	Δ	Δ	—	
	Internal Event 3 Controller alarm OR	5824	16C0	22208	56C0					—	
	Internal Event 3 Special OFF setup	5825	16C1	22209	56C1					—	
	Internal Event 3 Delay unit	5826	16C2	22210	56C2					—	
	(Reserved for future extension.)	5827	16C3	22211	56C3	Δ	Δ	Δ	Δ	—	
	Internal Event 4 Operation type	5828	16C4	22212	56C4					—	
	Internal Event 4 Direct/Reverse	5829	16C5	22213	56C5					—	
	Internal Event 4 Standby	5830	16C6	22214	56C6					—	
	Internal Event 4 state at READY	5831	16C7	22215	56C7					—	
	(Reserved for future extension.)	5832	16C8	22216	56C8	Δ	Δ	Δ	Δ	—	
	Internal Event 4 Controller alarm OR	5833	16C9	22217	56C9					—	
	Internal Event 4 Special OFF setup	5834	16CA	22218	56CA					—	
	Internal Event 4 Delay unit	5835	16CB	22219	56CB					—	
	(Reserved for future extension.)	5836	16CC	22220	56CC	Δ	Δ	Δ	Δ	—	
	Internal Event 5 Operation type	5837	16CD	22221	56CD					—	
	Internal Event 5 Direct/Reverse	5838	16CE	22222	56CE					—	
	Internal Event 5 Standby	5839	16CF	22223	56CF					—	
	Internal Event 5 state at READY	5840	16D0	22224	56D0					—	
	(Reserved for future extension.)	5841	16D1	22225	56D1	Δ	Δ	Δ	Δ	—	
	Internal Event 5 Controller alarm OR	5842	16D2	22226	56D2					—	
	Internal Event 5 Special OFF setup	5843	16D3	22227	56D3					—	
	Internal Event 5 Delay unit	5844	16D4	22228	56D4					—	
	(Reserved for future extension.)	5845	16D5	22229	56D5	Δ	Δ	Δ	Δ	—	
Parameter	Control method	6001	1771	22385	5771					—	
	MV low limit at AT	6002	1772	22386	5772					1	
	MV high limit at AT	6003	1773	22387	5773					1	
	Differential (for ON/OFF control)	6004	1774	22388	5774					P	
	ON/OFF control action point offset	6005	1775	22389	5775					P	
	PV filter	6006	1776	22390	5776					1	
	PV ratio	6007	1777	22391	5777					3	
	PV bias	6008	1778	22392	5778					P	
	(Reserved for future extension.)	6009	1779	22393	5779	Δ	Δ	Δ	Δ	1	
	(Reserved for future extension.)	6010	177A	22394	577A	Δ	Δ	Δ	Δ	3	
	(Reserved for future extension.)	6011	177B	22395	577B	Δ	Δ	Δ	Δ	P	
	Time proportional cycle unit 1	6012	177C	22396	577C					—	
	Time proportional cycle 1	6013	177D	22397	577D					—	
	Time proportional cycle unit 2	6014	177E	22398	577E					—	
	Time proportional cycle 2	6015	177F	22399	577F					—	
	Time proportional cycle mode	6016	1780	22400	5780					—	
	(Reserved for future extension.)	6017	1781	22401	5781	Δ	Δ	Δ	Δ	1	
	SP up ramp	6018	1782	22402	5782					S	
	SP down ramp	6019	1783	22403	5783					S	
	(Reserved for future extension.)	6020	1784	22404	5784	Δ	Δ	Δ	Δ	P	
SP	(Reserved for future extension.)	7001	1B59	23385	5B59	Δ	X	Δ	X	P	
	(Reserved for future extension.)	7002	1B5A	23386	5B5A	Δ	Δ	Δ	Δ	—	
	(Reserved for future extension.)	7003	1B5B	23387	5B5B	Δ	Δ	Δ	Δ	S	
	(Reserved for future extension.)	7004	1B5C	23388	5B5C	Δ	Δ	Δ	Δ	S	
	LSP1	7005	1B5D	23389	5B5D					P	Same as RAM address 13312 (decimal).
	(Reserved for future extension.)	7006	1B5E	23390	5B5E	Δ	Δ	Δ	Δ	—	

Bank	Item name	RAM address		EEPROM address		RAM		EEPROM		Decimal point information	Remarks
		Decimal	Hexadecimal	Decimal	Hexadecimal	Read	Write	Read	Write		
SP	(Reserved for future extension.)	7007	1B5F	23391	5B5F	Δ	Δ	Δ	Δ	S	
	(Reserved for future extension.)	7008	1B60	23392	5B60	Δ	Δ	Δ	Δ	S	
	LSP2	7009	1B61	23393	5B61					P	Same as RAM address 13313 (decimal).
	(Reserved for future extension.)	7010	1B62	23394	5B62	Δ	Δ	Δ	Δ	—	
	(Reserved for future extension.)	7011	1B63	23395	5B63	Δ	Δ	Δ	Δ	S	
	(Reserved for future extension.)	7012	1B64	23396	5B64	Δ	Δ	Δ	Δ	S	
	LSP3	7013	1B65	23397	5B65					P	Same as RAM address 13314 (decimal).
	(Reserved for future extension.)	7014	1B66	23398	5B66	Δ	Δ	Δ	Δ	—	
	(Reserved for future extension.)	7015	1B67	23399	5B67	Δ	Δ	Δ	Δ	S	
	(Reserved for future extension.)	7016	1B68	23400	5B68	Δ	Δ	Δ	Δ	S	
	LSP4	7017	1B69	23401	5B69					P	Same as RAM address 13315 (decimal).
	(Reserved for future extension.)	7018	1B6A	23402	5B6A	Δ	Δ	Δ	Δ	—	
	(Reserved for future extension.)	7019	1B6B	23403	5B6B	Δ	Δ	Δ	Δ	S	
	(Reserved for future extension.)	7020	1B6C	23404	5B6C	Δ	Δ	Δ	Δ	S	
Event	Internal Event 1 main setting	7501	1D4D	23885	5D4D					S	Same as RAM address 13056 (decimal).
	Internal Event 1 sub setting	7502	1D4E	23886	5D4E					S	Same as RAM address 13057 (decimal).
	Internal Event 1 Hysteresis	7503	1D4F	23887	5D4F					S	
	Internal Event 1 ON delay time	7504	1D50	23888	5D50					S	
	Internal Event 1 OFF delay time	7505	1D51	23889	5D51					S	
	Internal Event 2 main setting	7506	1D52	23890	5D52					S	Same as RAM address 13058 (decimal).
	Internal Event 2 sub setting	7507	1D53	23891	5D53					S	Same as RAM address 13059 (decimal).
	Internal Event 2 Hysteresis	7508	1D54	23892	5D54					S	
	Internal Event 2 ON delay time	7509	1D55	23893	5D55					S	
	Internal Event 2 OFF delay time	7510	1D56	23894	5D56					S	
	Internal Event 3 main setting	7511	1D57	23895	5D57					S	Same as RAM address 13060 (decimal).
	Internal Event 3 sub setting	7512	1D58	23896	5D58					S	Same as RAM address 13061 (decimal).
	Internal Event 3 Hysteresis	7513	1D59	23897	5D59					S	
	Internal Event 3 ON delay time	7514	1D5A	23898	5D5A					S	
	Internal Event 3 OFF delay time	7515	1D5B	23899	5D5B					S	
	Internal Event 4 main setting	7516	1D5C	23900	5D5C					S	Same as RAM address 13062 (decimal).
	Internal Event 4 sub setting	7517	1D5D	23901	5D5D					S	Same as RAM address 13063 (decimal).
	Internal Event 4 Hysteresis	7518	1D5E	23902	5D5E					S	
	Internal Event 4 ON delay time	7519	1D5F	23903	5D5F					S	
	Internal Event 4 OFF delay time	7520	1D60	23904	5D60					S	
Internal Event 5 main setting	7521	1D61	23905	5D61					S	Same as RAM address 13064 (decimal).	
Internal Event 5 sub setting	7522	1D62	23906	5D62					S	Same as RAM address 13065 (decimal).	
Internal Event 5 Hysteresis	7523	1D63	23907	5D63					S		
Internal Event 5 ON delay time	7524	1D64	23908	5D64					S		
Internal Event 5 OFF delay time	7525	1D65	23909	5D65					S		

Chapter 9. LIST OF COMMUNICATION DATA

Bank	Item name	RAM address		EEPROM address		RAM		EEPROM		Decimal point information	Remarks
		Decimal	Hexadecimal	Decimal	Hexadecimal	Read	Write	Read	Write		
Extended tuning	AT type	8501	2135	24885	6135					—	
	(Reserved for future extension.)	8502	2136	24886	6136	Δ	X	Δ	X	—	
	Just-FITTER settling band	8503	2137	24887	6137					—	
	SP lag time	8504	2138	24888	6138					1	
	(Reserved for future extension.)	8505	2139	24889	6139	Δ	X	Δ	X	—	
	AT Proportional band adjust	8506	213A	24890	613A					2	
	AT Integral time adjust	8507	213B	24891	613B					2	
	AT Derivative time adjust	8508	213C	24892	613C					2	
	Control algorithm	8509	213D	24893	613D					—	
	Just-FITTER overshoot limit/restraint/control coefficient	8510	213E	24894	613E					—	
	(Reserved for future extension.)	8511	213F	24895	613F	Δ	X	Δ	X	—	
	(Reserved for future extension.)	8512	2140	24896	6140	Δ	X	Δ	X	—	
	(Reserved for future extension.)	8513	2141	24897	6141	Δ	X	Δ	X	—	
	(Reserved for future extension.)	8514	2142	24898	6142	Δ	X	Δ	X	—	
	ST (Self-tuning) step execution resolution width	8515	2143	24899	6143					2	
	ST (Self-tuning) step settling width	8516	2144	24900	6144					2	
ST (Self-tuning) hunching settling bound	8517	2145	24901	6145					2		
ST (Self-tuning) step ramp change	8518	2146	24902	6146					—		
Mode	AUTO/MANUAL	9001	2329	25385	6329		*		*	—	Same as RAM address 14596 (decimal). Writing is enabled under no DI Assignment and other conditions. 0: AUTO mode 1: MANUAL mode
	RUN/READY	9002	232A	25386	632A		*		*	—	Same as RAM address 14595 (decimal). Writing is enabled under no DI Assignment conditions. 0: RUN mode 1: READY mode
	(Reserved for future extension.)	9003	232B	25387	632B	Δ	X	Δ	X	—	Same as RAM address 14598 (decimal).
	AT stop/start	9004	232C	25388	632C		*		*	—	Same as RAM address 14597 (decimal). Writing is enabled under no DI Assignment and other conditions. 0: AT stop 1: AT start
	Release all DO latches	9005	232D	25389	632D		*		*	—	Writing is enabled under no DI Assignment conditions. 0: Latch continue 1: Latch release
Operation display	PV	9101	238D	25485	638D		X		X	P	Same as RAM address 14356 (decimal).
	SP (Target value)	9102	238E	25486	638E					P	
	LSP group selection	9103	238F	25487	638F		*		*	—	Same as RAM address 14592 (decimal). Writing is enabled under no DI Assignment conditions.
	(Reserved for future extension.)	9104	2390	25488	6390	Δ	X	Δ	X	—	
	MV (Manipulated Variable)	9105	2391	25489	6391		*		*	1	Same as RAM address 14594 (decimal). Writing is enabled in the MANUAL mode.

Bank	Item name	RAM address		EEPROM address		RAM		EEPROM		Decimal point information	Remarks
		Decimal	Hexadecimal	Decimal	Hexadecimal	Read	Write	Read	Write		
Operation display	Heat MV (Manipulated Variable)	9106	2392	25490	6392		X		X	1	Same as RAM address 14420 (decimal).
	Cool MV (Manipulated Variable)	9107	2393	25491	6393		X		X	1	Same as RAM address 14421 (decimal).
	(Reserved for future extension.)	9108	2394	25492	6394	Δ	X	Δ	X	1	Same as RAM address 14417 (decimal).
	AT progress	9109	2395	25493	6395		X		X	—	
	CT (Current transformer) current value 1	9110	2396	25494	6396		X		X	1	Same as RAM address 14418 (decimal).
	CT (Current transformer) current value 2	9111	2397	25495	6397					1	Same as RAM address 14419 (decimal).
	Timer remain time 1	9112	2398	25496	6398		X		X	S	
	Timer remain time 2	9113	2399	25497	6399		X		X	S	
	Timer remain time 3	9114	239A	25498	639A		X		X	S	
	Timer remain time 4	9115	239B	25499	639B		X		X	S	
	Timer remain time 5	9116	239C	25500	639C		X		X	S	
	(Reserved for future extension.)	9117	239D	25501	639D	Δ	X	Δ	X	S	
	(Reserved for future extension.)	9118	239E	25502	639E	Δ	X	Δ	X	S	
	(Reserved for future extension.)	9119	239F	25503	639F	Δ	X	Δ	X	S	
	(Reserved for future extension.)	9120	23A0	25504	63A0	Δ	X	Δ	X	S	
	(Reserved for future extension.)	9121	23A1	25505	63A1	Δ	X	Δ	X	S	
	(Reserved for future extension.)	9122	23A2	25506	63A2	Δ	X	Δ	X	S	
	LSP value in use	9123	23A3	25507	63A3					P	Same as RAM address 14593 (decimal).
PV before ratio, bias, and filter	9124	23A4	25508	63A4		X		X	P		
(Reserved for future extension.)	9125	23A5	25509	63A5	Δ	X	Δ	X	P		
Status	Input alarm status	9201	23F1	25585	63F1		X		X	—	Bit 0: AL01 (PV over-range) Bit 1: AL01 (PV under-range) Bit 2: AL03 (CJ, RTD burnout) Bits 3 to 15: Undefined.
	Instrument alarm status	9202	23F2	25586	63F2		X		X	—	Bits 0 to 1: Undefined. Bit 2: AL70 (A/D) Bit 3: AL95 (Set data) Bit 4: AL96 (Adjustment data) Bit 5: AL97 (Set data/RAM) Bit 6: AL98 (Adjustment data/RAM) Bit 7: AL99 (ROM) Bits 8 to 15 Undefined.
	Internal Event/Internal Contact control status	9203	23F3	25587	63F3		X		X	—	Bits 0 to 4: Internal Event 1 to 5 Bits 5 to 7: Undefined. Bits 8 to 10: Internal Contact 1 to 3 Bits 11 to 15: Undefined.

Chapter 9. LIST OF COMMUNICATION DATA

Bank	Item name	RAM address		EEPROM address		RAM		EEPROM		Decimal point information	Remarks
		Decimal	Hexadecimal	Decimal	Hexadecimal	Read	Write	Read	Write		
Status	Control status	9204	23F4	25588	63F4		X		X	—	Bit 0: MANUAL mode 0: AUTO 1: MANUAL Bit 1: READY mode 0: RUN mode 1: READY mode Bit 2: Undefined. Bit 3: During AT Bit 4: During ST Bit 5: Undefined. Bit 6: During SP ramp Bit 7: During SP up ramp Bit 8: During SP down ramp Bits 9 to 12: Undefined. Bit 13: PID (Heat) is being used. Bit 14: PID (Cool) is being used. Bit 15: Undefined.
	DO status	9205	23F5	25589	63F5		X		X	—	Same as RAM address 14337 (decimal). Bit 0: Control output 1 Bit 1: Control output 2 Bit 2: Event output 1 Bit 3: Event output 2 Bit 4: Event output 3 Bits 5 to 15: Undefined.
	DI status	9206	23F6	25590	63F6		X		X	—	Same as RAM address 14338 (decimal). Bit 0: DI1 Bit 1: DI2 Bits 3 to 15: Undefined.
	Communication DI (DI1 to 4)	9207	23F7	25591	63F7					—	Bit 0: Communication DI1 Bit 1: Communication DI2 Bit 2: Communication DI3 Bit 3: Communication DI4
	Communication DI1	9208	23F8	25592	63F8					—	Bit 0: Communication DI1
	Communication DI2	9209	23F9	25593	63F9					—	Bit 0: Communication DI2
	Communication DI3	9210	23FA	25594	63FA					—	Bit 0: Communication DI3
	Communication DI4	9211	23FB	25595	63FB					—	Bit 0: Communication DI4
Tag	Tag 1	9301	2455	25685	6455					—	Display and setting cannot be made with the console.
	Tag 2	9302	2456	25686	6456					—	Same as above.
	Tag 3	9303	2457	25687	6457					—	Same as above.
	Tag 4	9304	2458	25688	6458					—	Same as above.
	Tag 5	9305	2459	25689	6459					—	Same as above.
	Tag 6	9306	245A	25690	645A					—	Same as above.
	Tag 7	9307	245B	25691	645B					—	Same as above.
	Tag 8	9308	245C	25692	645C					—	Same as above.
	Tag 9	9309	245D	25693	645D					—	Same as above.
	Tag 10	9310	245E	25694	645E					—	Same as above.
	Tag 11	9311	245F	25695	645F					—	Same as above.
	Tag 12	9312	2460	25696	6460					—	Same as above.
	Tag 13	9313	2461	25697	6461					—	Same as above.
	Tag 14	9314	2462	25698	6462					—	Same as above.
	Tag 15	9315	2463	25699	6463					—	Same as above.
	Tag 16	9316	2464	25700	6464					—	Same as above.

Bank	Item name	RAM address		EEPROM address		RAM		EEPROM		Decimal point information	Remarks
		Decimal	Hexadecimal	Decimal	Hexadecimal	Read	Write	Read	Write		
PID	P (Proportional band) (P-1)	12288	3000	28672	7000					1	
	I (Integral time) (I-1)	12289	3001	28673	7001					—	
	D (Derivative time) (D-1)	12290	3002	28674	7002					—	
	Manual reset (RE-1)	12291	3003	28675	7003					1	
	Output low limit (OL-1)	12292	3004	28676	7004					1	
	Output high limit (OH-1)	12293	3005	28677	7005					1	
	P (Proportional band)(cool) (P-1.C)	12336	3030	28720	7030					1	
	I (Integral time)(cool) (I-1.C)	12337	3031	28721	7031					—	
	D (Derivative time)(cool) (D-1.C)	12338	3032	28722	7032					—	
	(Reserved for future extension.)	12339	3033	28723	7033	Δ	Δ	Δ	Δ	1	
Output low limit (Cool) (OL1.C)	12340	3034	28724	7034					1		
Output high limit (Cool) (OH1.C)	12341	3035	28725	7035					1		
Event	Internal Event 1 main setting	13056	3300	29440	7300					S	
	Internal Event 1 sub setting	13057	3301	29441	7301					S	
	Internal Event 2 main setting	13058	3302	29442	7302					S	
	Internal Event 2 sub setting	13059	3303	29443	7303					S	
	Internal Event 3 main setting	13060	3304	29444	7304					S	
	Internal Event 3 sub setting	13061	3305	29445	7305					S	
	Internal Event 4 main setting	13062	3306	29446	7306					S	
	Internal Event 4 sub setting	13063	3307	29447	7307					S	
	Internal Event 5 main setting	13064	3308	29448	7308					S	
	Internal Event 5 sub setting	13065	3309	29449	7309					S	
LSP	LSP1	13312	3400	29696	7400					P	
	LSP2	13313	3401	29697	7401					P	
	LSP3	13314	3402	29698	7402					P	
	LSP4	13315	3403	29699	7403					P	
Instrument status 1	Typical alarm	14336	3800	30720	7800		X		X	—	Bit 0: PV failure (AL01 to 03) Bits 1 to 11: Undefined. Bit 12: Hardware failure (AL70) Bit 13: Parameter failure (AL95/97) Bit 14: Adjustment data failure (AL96/98) Bit 15: ROM failure (AL99)
	DO status	14337	3801	30721	7801		X		X	—	Same as RAM address 9205 (decimal).
	DI status	14338	3802	30722	7802		X		X	—	Same as RAM address 9206 (decimal).
Instrument status 2	RUN/READY	14352	3810	30736	7810		X		X	—	
	AUTO/MANUAL	14353	3811	30737	7811		X		X	—	
	AT stop/start	14354	3812	30738	7812		X		X	—	
	(Reserved for future extension.)	14355	3813	30739	7813	Δ	X	Δ	X	—	
	PV	14356	3814	30740	7814		X		X	P	
	SP (Target value)	14357	3815	30741	7815		X		X	P	
MV (Manipulated Variable)	14358	3816	30742	7816		X		X	1		

Chapter 9. LIST OF COMMUNICATION DATA

Bank	Item name	RAM address		EEPROM address		RAM		EEPROM		Decimal point information	Remarks
		Decimal	Hexadecimal	Decimal	Hexadecimal	Read	Write	Read	Write		
Instrument status 3	(Reserved for future extension.)	14416	3850	30800	7850	Δ	X	Δ	X	P	Same as RAM address 7001 (decimal).
	(Reserved for future extension.)	14417	3851	30801	7851	Δ	X	Δ	X	1	Same as RAM address 9108 (decimal).
	CT (Current transformer) input 1 current value	14418	3852	30802	7852		X		X	1	Same as RAM address 9110 (decimal).
	CT (Current transformer) input 2 current value	14419	3853	30803	7853		X		X	1	Same as RAM address 9111 (decimal).
	Heat MV (for heat/cool control)	14420	3854	30804	7854		X		X	1	Same as RAM address 9106 (decimal).
	Cool MV (for heat/cool control)	14421	3855	30805	7855		X		X	1	Same as RAM address 9107 (decimal).
Operation	LSP group selection	14592	3900	30976	7900		*		*	—	Writing is enabled under no DI Assignment conditions. Same as RAM address 9103 (decimal).
	LSP value in use	14593	3901	30977	7901					P	Same as RAM address 9123 (decimal).
	Manual manipulated variable (MV)	14594	3902	30978	7902		*		*	1	Writing is enabled in the MANUAL mode. Same as RAM address 9105 (decimal).
	RUN/READY	14595	3903	30979	7903		*		*	—	Writing is enabled under no DI Assignment conditions. Same as RAM address 9002 (decimal).
	AUTO/MANUAL	14596	3904	30980	7904		*		*	—	Writing is enabled under no DI Assignment and other conditions. Same as RAM address 9001 (decimal).
	AT stop/start	14597	3905	30981	7905		*		*	—	Writing is enabled under no DI Assignment and other conditions. Same as RAM address 9004 (decimal).
	(Reserved for future extension.)	14598	3906	30982	7906	Δ	X	Δ	X	—	Same as RAM address 9003 (decimal).
PID group in use	P (Proportional band)	14848	3A00	31232	7A00					1	
	I (Integral time)	14849	3A01	31233	7A01					—	
	D (Derivative time)	14850	3A02	31234	7A02					—	
	Manual reset	14851	3A03	31235	7A03					1	
	MV low limit	14852	3A04	31236	7A04					1	
	MV high limit	14853	3A05	31237	7A05					1	
	P (Proportional band) (cool)	14854	3A06	31238	7A06					1	
	I (Integral time) (cool)	14855	3A07	31239	7A07					—	
	D (Derivative time) (cool)	14856	3A08	31240	7A08					—	
	(Reserved for future extension.)	14857	3A09	31241	7A09	Δ	Δ	Δ	Δ	1	
	Output low limit (Cool)	14858	3A0A	31242	7A0A					1	
	Output high limit (Cool)	14859	3A0B	31243	7A0B					1	

Chapter 10. MAINTENANCE AND TROUBLESHOOTING

■ Maintenance

● Cleaning

When removing the dirt from the measuring instrument, wipe it off with a soft cloth rag. At this time, do not use any organic solvent, such as paint thinner or benzene.

● Part replacement

Do not replace any parts of this unit.

● Fuse replacement

When replacing the fuse connected to the electric wiring, always use the specified standard fuse.

Standard	IEC127
Shut-down speed	Slow-action type (T)
Rated voltage	250V
Rated current	200mA

■ Alarm displays and corrective action

The following Table shows the alarm displays and corrective actions if any failure occurs in this unit:

Alarm code	Failure name	Cause	Corrective action
<i>AL01</i>	PV input failure (Over-range)	Sensor burnout, incorrect wiring, incorrect PV input type setting	Check the wiring. Check the PV input type setting.
<i>AL02</i>	PV input failure (Under-range)	Sensor burnout, incorrect wiring, incorrect PV input type setting	
<i>AL03</i>	CJ failure	Terminal temperature is faulty (thermocouple).	Use the unit at an ambient temperature meeting the operating conditions stated in the specification.
	PV input failure	Sensor burnout, incorrect wiring (RTD)	Check the wiring.
<i>AL70</i>	A/D conversion failure	A/D converter is faulty.	It is thought that the main body needs to be replaced. Contact Yamatake or its dealer.
<i>AL95</i>	Set data failure	Data is corrupted by noise. Power is shut-down while the data is being set.	Turn ON the power again. If the same alarm occurs after that, set the data (set data for AL95/97 and adjustment data for AL96/98) and turn ON the power again. If the same alarm occurs again even after the above steps have been taken, the main body needs to be replaced. Contact Yamatake or its dealer.
<i>AL96</i>	Adjustment data failure	Power is shut-down while the data is being set. Data is corrupted by noise.	
<i>AL97</i>	Set data failure (RAM area)	Data is corrupted by noise.	
<i>AL98</i>	Adjustment data failure (RAM area)	Data is corrupted by noise.	
<i>AL99</i>	ROM failure	ROM (memory) is faulty.	Turn ON the power again. If the same alarm occurs again, the main body needs to be replaced. Contact Yamatake or its dealer.

■ **Operation in case of PV input failure**

(1) AL01, 02, or 03 occurs.

Control output: It is possible to make the settings so that the operation is continued or not continued.

Other operation: Operation is continued.

(2) AL occurs in cases other than those shown above.

All operations are continued.

The following Table shows the indications and alarms of this unit by the sensor type if PV input failure occurs:

● **Thermocouple**

Failure status	Range No.	Indication value	Alarm code
Sensor burnout		Upscale (110%FS)	AL01
CJ failure		PV having incorrect cold contact compensation	AL03
Over-range, burnout	19 (PLII)	1365°C (105%FS)	AL01

● **RTD**

Failure status	Range No.	Indication value	Alarm code
RTD burnout		Upscale (110%FS)	AL01
A-wire burnout		Upscale (110%FS)	AL01
B-wire burnout		Upscale (110%FS)	AL01, AL03
C-wire burnout		Upscale (110%FS)	AL01, AL03
2- or 3-wire burnout		Upscale (110%FS)	AL01, AL03
A- and B-wire short-circuit		Downscale (-10%FS)	AL02
A- and C-wire short-circuit		Downscale (-10%FS)	AL02
A- and B-wire/A- and C-wire short-circuit	41 (Pt100)	-235°C (-5%FS)	AL02
A- and B-wire/A- and C-wire short-circuit	42 (JPt100)	-235°C (-5%FS)	AL02

● **DC voltage/DC current**

Failure status	Range No.	Indication value	Alarm code
Burnout	84 (0 to 1V)	Downscale (-3%FS)	AL02
	86 (1 to 5V)	Downscale (-10%FS)	AL02
	87 (0 to 5V)	Downscale (-3%FS)	AL02
	88 (0 to 10V)	Downscale (0%FS)	None
	89 (0 to 20mA)	Unknown (around 0%FS)	None
	90 (4 to 20mA)	Downscale (-10%FS)	AL02

Chapter 11. CALIBRATION

CAUTION



Do not change the mode to the calibration mode while the control object is being operated.
When this unit is put in the calibration mode, the control output and event output enter the fixed status and they do not function. Always start the calibration by considering this point carefully.

Handling Precautions

It may be required to disconnect and reconnect the wiring for calibration. At this time, strictly observe the warnings and cautions about wiring stated in Chapter 4, WIRING.

This chapter describes how to calibrate this unit.

To calibrate this unit, Smart Loader Package SLP-C35 is required.

■ Starting the calibration

Start up the Smart Loader Package SLP-C35. On the menu screen that appears when the Smart Loader Package SLP-C35 is started up, select [Calibration (J)] from the [Menu (M)] pull-down menu. The [Calibrate] confirmation screen will appear.

On this screen, select [OK]. The Calibration screen will appear and this unit also enters the calibration mode.

When this unit is in the calibration mode, “tEst” will appear on the lower display. However, note that another message appears when inspecting the LED.

Handling Precautions

- Yamatake shall not be held responsible for any defects arising from improper calibration made by the customer.
- To return the unit to the calibration status of the default settings before shipment during calibration, follow the steps below. From the pull-down menu, select [Command] → [Data retrieval]. The data, which has been calibrated, is disposed of and the data is then returned to the default settings before shipment. If this operation is performed accidentally during calibration, all contents, which have been calibrated by the customer, will be lost.

■ Exiting the calibration

To exit the calibration, perform either of the following operations:

- (1) On the Calibration screen of the Smart Loader Package, select [Quit (Q)] from the [File (F)] pull-down menu.
- (2) Click [X] at the upper right corner of the Calibration screen to close the screen. The screen will be returned to the menu screen and the unit also returns to the normal mode.

Handling Precautions

If the loader cable is disconnected before starting the calibration exit operation with the Smart Loader Package, this unit is continuously kept in the calibration mode. At this time, turn OFF the power, and turn it ON again. The unit will return to the normal mode.

■ Cautions before starting the calibration

When calibrating the unit, strictly observe the following cautions. Failure to do so may cause faulty accuracy:

- Before starting the calibration, supply the power to this unit for at least 1 hr.
- The ambient temperature of the calibration place must conform the standard conditions specified in the unit specifications.
- Do not calibrate the unit in a place where it is in contact with the wind or the ambient temperature fluctuates.
- Do not calibrate the unit with the measuring instruments having lower specifications stated in the next section, **■ Measuring instruments required for calibration**.

■ Measuring instruments required for calibration

Measuring instrument	Specifications
Reference current/voltage generator	Accuracy: $\pm 0.1\%$ or less, Minimum resolution: 100 μV or less (voltage), Minimum resolution: 100 μA or less (current)
Resistor	Accuracy: $\pm 0.1\%$ or less, Minimum resolution: 0.1 Ω or less
Ammeter	Accuracy: $\pm 0.1\%$ or less, Minimum resolution: 1 μA or less
Thermometer	Accuracy: $\pm 0.1^\circ\text{C}$ or less, Minimum resolution: 0.1 $^\circ\text{C}$ or less

■ Calibration procedures

● I/O check

- (1) Select the [I/O Check] tab.
- (2) Select a desired item from the check contents.
- (3) Click [Execute].

The input system (key and digital input) is shown on the personal computer screen while the input status (ON/OFF) of this unit is being read continuously.

For the output system (control output and event output), the status (ON/OFF) you have checked on desired check boxes is output from the output terminal of this unit.

● PV input calibration

- (1) Select the [PV Calibration] tab.
- (2) Select the gain No. in the ascending order and perform the operation from step (3).
- (3) Click [Read].
- (4) Apply the voltage, current, and resistance values written next to the gain No. to the PV input terminal.

For details about how to connect measuring instruments in the apply status, refer

- The PV input type is T (thermocouple).

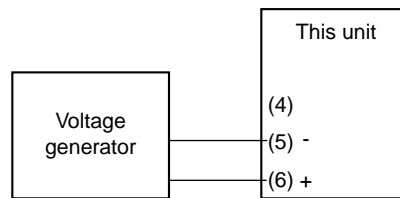

- The PV input type is R (RTD).

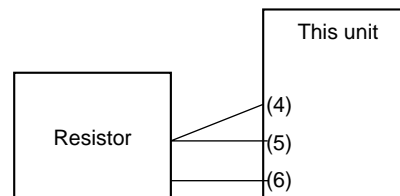

- The PV input type is L (DC voltage/DC current).

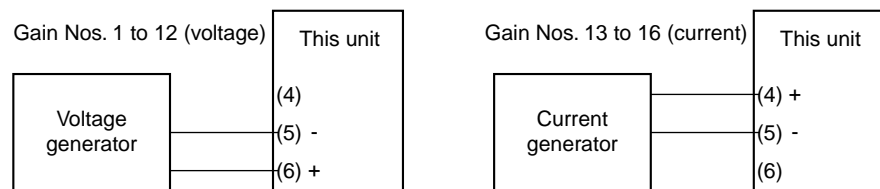

- (5) Keep the apply status for approximately 30 sec.
- (6) Click [Write].
- (7) Return to step (2) until the final gain No. is completed.

Handling Precautions

- In the PV input calibration, always adjust all gains.
- Do not leave the PV input terminal open during heat-up between power ON of this unit and starting of calibration. When the input type is thermocouple or DC voltage, put the unit in the 0V-input (or terminals are short-circuited) status. When the input type is RTD, put the unit in the 100 Ω -input (or terminals are short-circuited) status.

● **CT (Current Transformer) input calibration**

- (1) Select the [CT input calibration] tab.
- (2) Select a desired channel to be calibrated.
- (3) Select [Zero] from the zero span selection items.
(When selecting a channel, perform the [Zero] calibration first, and then perform the [Span] calibration next since “Zero/Span” is set for one channel.)
- (4) Click [Read].
- (5) A current value of “0” is applied to the CT input terminal of the channel you have selected and keep the apply status for approximately 30 sec. For details about how to connect measuring instruments in the apply status, refer to the following Figures:

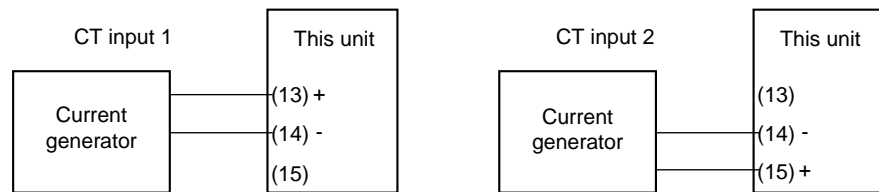

- (6) Click [Write].
- (7) Select [Span] from the zero span selection items.
- (8) Click [Read].
- (9) Apply a span current value to the CT input terminal of the channel you have selected and keep the apply status for approximately 30 sec.
- (10) Click [Write].
- (11) If any channels to be calibrated remain, return to operation step (2).

! Handling Precautions

To calibrate the CT input, connect the DC current (mA) to the input terminal.

● Current output calibration

- (1) Select the [Analog Output Calibration] tab.
- (2) Select a desired channel to be calibrated.
Select [ch1] for control output 1 and [ch2] for control output 2.
- (3) Select [Zero] from the zero span selection items.
(When selecting a channel, perform the [Zero] calibration first, and then perform the [Span] calibration next since “Zero/Span” is set for one channel.)
- (4) When clicking [Read], the zero calibration current is output to the output terminal of the channel you have selected.
For details about how to connect measuring instruments, refer to the following Figures:

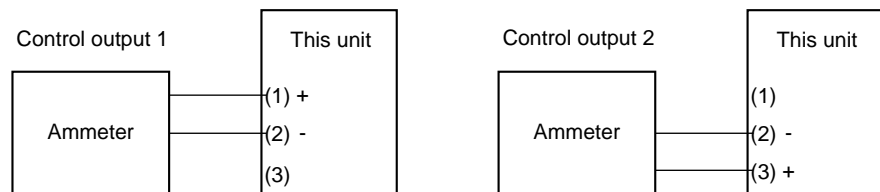

- (5) Keep this status for approximately 30 sec.
- (6) Read the current value in units of 0.001 mA from the ammeter, input it in [Current (mA)/Voltage (V)], and click [Write].
- (7) Select [Span] from the zero span selection items.
- (8) When clicking [Read], the span calibration current is output to the output terminal of the channel you have selected.
- (9) Keep this status for approximately 30 sec.
- (10) Read the current value in units of 0.001 mA from the ammeter, input it in [Current (mA)/Voltage (V)], and click [Write].
- (11) If any channels to be calibrated remain, return to operation step (2).

Chapter 12. DISPOSAL

When disposing of this unit, dispose of the unit properly as industrial waste according to the applicable laws and regulations specified by the local governmental office.

Chapter 13. SPECIFICATIONS

■ Specifications

● PV input

Input type:	Thermocouple K, J, E, T, R, S, B, N (JIS C1602-1995) PL II (Engelhard Industries data(ITS90)) WRe5-26 (ASTM E988-96(Reapproved 2002)) DIN U, DIN L (DIN43710-1985) RTD Pt100 (JIS C1604-1997), JPt100 (JIS C1604-1989) DC voltage 0 to 1Vdc, 1 to 5Vdc, 0 to 5Vdc, 0 to 10Vdc DC current 0 to 20mAdc, 4 to 20mAdc
Sampling cycle time:	500ms
Indication accuracy:	$\pm 0.5\%FS \pm 1$ digit, $\pm 1\%FS \pm 1$ digit in the negative area of the thermocouple (Specified by the input conversion at an ambient temperature of $23 \pm 2^\circ C$) However, the accuracy of the B-thermocouple is $\pm 5\%FS$ at a temperature of $260^\circ C$ or less and $\pm 1\%FS$ at a temperature of 260 to $800^\circ C$.
PV bias:	-1999 to +9999 or -199.9 to +999.9

• Thermocouple (T/C) input

Input bias current:	$+0.2\mu A$ (Flowed from the A terminal.)
Burnout indication:	Upscale + AL01

• Resistance temperature detector (RTD) input

Input bias current:	Approx. $+1mA$ (Flowed from the A terminal.)
Burnout indication:	RTD burnout or A-wire burnout Upscale + AL01 B-wire burnout or C-wire burnout Upscale + AL01, AL03 2 or more wires burnout Upscale + AL01, AL03
Allowable wiring resistance:	Max. 10Ω at range No.51 to 64, max. 85Ω the other ranges.
Influence of wiring resistance:	Max. $\pm 0.05\% FS/\Omega$ Max. 10Ω at range No.51 to 64, max. 85Ω the other ranges.

• DC voltage input

Input impedance:	Min. $1M\Omega$
Input bias current:	0 to 1V range $1\mu A$ (sucked to the A terminal) 0 to 5V, 1 to 5V range $3.5\mu A$ (sucked to the A terminal) 0 to 10V range $7\mu A$ (sucked to the A terminal)
Burnout indication:	Downscale + AL02 However, the burnout cannot be detected in a range of 0 to 10V.

• DC current input

Input impedance:	Max. 100Ω
Burnout indication:	Downscale + AL02 However, the burnout cannot be detected in a range of 0 to 20mA.

● Control output

• Relay output

Contact rating:	Control output 1 NO side 250Vac/30Vdc, 3A (resistance load) Control output 2 NC side 250Vac/30Vdc, 1A (resistance load)
Life:	50,000 cycles or more on NO side 100,000 cycles or more on NC side
Min. open/close specifications:	5V, 100mA
Min. open time/close times	250ms

• **Voltage pulse output (For SSR drive)**

Open voltage:	19Vdc±15%
Internal resistance:	82Ω±0.5%
Allowable current:	Max. 24mAdc
OFF leak current:	Max. 100μA
Min. OFF time/ ON time:	1ms when the time proportional cycle time is less than 10s. 250ms when the time proportional cycle time is more than 10s.

• **Current output**

Output type:	0 to 20mAdc or 4 to 20mAdc (current output)
Allowance load resistance:	Max. 600Ω
Output accuracy:	±0.5%FS (under standard conditions) However, ±1.0%FS in a range of 0 to 1mA.

● **Digital input**

Number of input points:	2 points
Input type:	No-voltage contact or open collector
Allowable ON contact resistance:	Max. 250Ω
Allowable OFF contact resistance:	Min.100 kΩ
Allowable ON-state residual voltage:	Max. 1.0V
Open terminal voltage:	5.5Vdc ± 1V
ON terminal voltage:	Approx. 7.5mA (at short-circuit), Approx. 5.0mA (at contact resistance of 250Ω)
Minimum hold time:	1s or more

● **Current transformer input**

Number of input points:	2 points
Input object:	Number of current transformer windings 800 turns Optional unit Model No.: QN206A (Hole diameter: 5.8 mm) Optional unit Model No.: QN212A (Hole diameter: 12mm)
Measurement current range:	0.4 to 50A
Max. measurement current:	70A
Display range:	0.0 to 70.0A
Display accuracy:	±5%FS
Display resolution:	0.1A

● **Event relay output**

Number of output points:	0 to 3 points (This may vary depending on the model.)
Output type:	SPST contact 3 points, Common 2 points, Each individual point
Output rating:	250Vac/30Vdc, 2A (Resistance load)
Service life:	100,000 cycles or more
Min. open/close specifications:	5V, 10mA (Reference value)

- **RS-485 communication**

Transmission line:	3-wire method
Transmission speed:	4800, 9600, 19200, 38400 bps
Communication distance:	Max. 500m
CPL/MODBUS: Communication protocol:	Half duplex, start/stop synchronization method
Number of connection units:	In conformity with CPL and MODBUS
Terminating resistor:	Max. 31 units
	Connection prohibited.

- **Loader communication**

Transmission line:	3-wire method
Transmission speed:	Fixed at 19200 bps.
Recommended cable:	Specially designed cable, 2m Model No.: 81440793-001

- **Isolation between input and output**

Portions enclosed by solid lines are insulated from other signals.

Power supply	Internal circuit	Control output 1
PV input		Control output 2
CT input 1		Event output 1 *
CT input 2		
Loader communication		
Digital input 1		Event output 2 *
Digital input 2		
RS-485 communication		
		Event output 3

Whether or not inputs and outputs are provided may vary depending on the model.

* In case of the independent contacts, the output 1 and the output 2 are isolated.

- **Environment conditions**

- **Standard conditions**

Ambient temperature:	23±2°C
Ambient humidity:	60±5%RH
Power supply voltage:	AC power model, 105Vac±1%, 50/60Hz±1Hz
	DC power model, 24Vac±1%, 50/60Hz±1Hz
	24Vdc±5%
Vibration:	0m/s ²
Shock:	0m/s ²
Mounting angle:	(Reference plane) ±3°

- **Operating conditions**

Ambient temperature:	0 to 50°C (0 to 40°C for tight-mounting)
Ambient humidity:	10 to 90%RH (No condensation allowed.)
Power supply voltage:	AC power model, 85 to 264Vac, 50/60Hz±2Hz
	(Rating: 100 to 240Vac, 50/60Hz)
	DC power model, 21.6 to 26AVac, 50/60Hz±2Hz/21.6 to 52.8Vdc
	(Rating: 24Vac, 50/60Hz 24 to 48Vdc)
Vibration:	0 to 2m/s ² (10 to 60Hz for 2 hrs. in each of the X-, Y-, and Z-direction)
Shock:	0 to 10m/s ²
Mounting angle:	(Reference plane) ±10°

- **Transportation conditions**

Ambient temperature:	-20 to +70°C
Ambient humidity:	10 to 95%RH (No condensation allowed.)

● **Other specifications**

- Dust-proof and drip-proof performance: Front panel of the unit conforms to IP66/NEMA 4X.
(Individual panel mounting with attached gaskets)
- Power consumption: AC power model, Max. 12VA (8VA at 100Vac and 12VA at 264Vac)
(When using the functions similar to those of Yamatake's SDC10, the power consumption is 6VA at 100Vac and 9VA at 264Vac.)
DC power model, Max. 7VA (24Vac), Max. 5W (24 to 48Vdc)
- Altitude: 2000m or less
- Insulation resistance: Between power supply terminal and secondary terminal, 500Vdc, 10MΩ or more
- Dielectric strength: AC power model, Between power supply terminal and secondary terminal, 1500Vac for 1 min.
DC power model, Between power supply terminal and secondary terminal, 500Vac for 1min.
- Inrush current at power ON: AC power model, Max. 20A
DC power model, Max. 20A
- Mass: Panel mounting type Approx. 150g (including mounting bracket)
Socket mounting type Approx. 200g (including socket)
- Terminal screw tightening torque: Panel mounting type 0.4 to 0.6N·m
Socket mounting type 0.78 to 0.98N·m or less
- Applicable standards: CE; EN61010-1, EN61326-1
UL; File No. E96090
- Over-voltage category: Category II (IEC60364-4-443, IEC60664-1)
- Allowable pollution degree: Pollution degree 2
- Decoration sheet material/color: Polyester film/Dark gray (DK546)
- Case material/color: Reformed PPE/Light gray (DIC650)

■ **Accessories and optional parts**

Name	Model No.
Mounting bracket (For C15T)	81446403-001 (Accessory)
Gasket	81409657-001 (Accessory)
Current transformer (Hole diameter: 5.8mm)	QN206A
Current transformer (Hole diameter: 12mm)	QN212A
Socket (For C15S)	81446391-001
Hard cover	81446442-001
Soft cover	81446443-001
Terminal cover	81446898-001
Smart Loader Package	SLP-C35J50
L-shaped plug adaptor	81441057-001

Appendix

Glossary

Abbreviations are used in the descriptions, tables, and figures in this manual. The following shows the main abbreviations:

AT	Auto Tuning
CT	Current Transformer
DI	Digital Input
DO	Digital Output (Control outputs of relay and voltage pulse, and event output)
EV	Event
LSP	Local Set Point. The meaning of LSP and SP is same in case of the SDC15.
MFB	Motor Feed Back. This indicates the feed back of motor opening which is used for position proportional control. (This controller does not have MFB function.)
MV	Manipulated Variable
PV	Process Variable
RSP	Remote Set Point. This is the set point which is set by the analog input from an external device. (This controller does not have RSP function.)
SP	Set Point
ST	Self-Tuning
U	Unit. This indicates the minimum digit of the selected PV input range with industrial unit (°C, Pa, l/min., etc.). 1U = 1°C in a range of -200 to +200°C. 1U = 0.1°C in a range of 0.0 to 200.0°C. Additionally, 1U = 0.01 when the DC voltage input is scaled to 0.00 to 10.00. Furthermore, 0.1U means 1/10 of 1U.

Index

-Number-

- 3-wire system..... 4-5
- 5-wire system..... 4-6

-A-

- Accessories..... 1-3
- Alarm code..... 10-1
- Alarm..... 5-44
- Application example..... 5-59
- Application layer..... 7-5, 7-3
- AT progress display..... 6-1
- AT start..... 5-21
- AT Stop/Start..... 5-8
- Auto tuning..... 5-18, 5-21
- AUTO/MANUAL mode..... 5-7

-C-

- Calibration..... 11-1
- CE marking..... 1-1
- Checksum..... 7-4
- Cold junction compensation (T/C)..... 5-1, 5-3
- Command..... 7-5
- Communication DI..... 5-8
- Communication lock..... 5-80
- Communication mode..... 7-1
- Communication monitor display..... 5-75
- Communications function..... 7-1
- Communications procedures..... 7-2
- Connection of communication cable..... 4-5
- Console display..... 5-70
- Console..... 1-4
- Console..... 2-2
- Constant current type..... 4-7
- Continuous data read..... 7-6
- Continuous data write..... 7-7
- Continuous output..... 5-66
- Control action (Direct)..... 5-44
- Control action..... 5-12
- Control method..... 5-11
- Control output type..... 1-1
- Control output..... 2-1
- Control subject of interference system..... 5-26
- Controller alarm OR..... 5-47
- CPL communications..... 7-1
- CR filter..... 4-9
- Crimp type terminal..... 4-4

- CT (current transformer) input..... 2-1, 5-68
- CT display setup..... 5-75
- CT input calibration..... 11-4
- CT measurement wait time..... 5-69
- CT operation type..... 5-69
- CT output..... 5-69
- Current output calibration..... 11-5
- Current output..... 5-66
- Current transformer input..... 2-1
- Current transformer..... 1-3

-D-

- Data format..... 7-1
- Data link layer..... 7-3
- Data setting procedures..... 2-6
- Decimal point position..... 5-1, 5-4
- Delay unit..... 5-47
- Derivative time..... 5-14
- Deviation high limit..... 5-39
- Deviation high/low limit..... 5-39
- Deviation low limit..... 5-39
- Device ID code..... 7-3, 7-4
- DI..... 5-32
- Digital input..... 2-1, 4-5, 5-8, 5-32
- Digital output..... 5-51
- DIN rail..... 3-6
- DISPOSAL..... 12-1
- DO..... 5-51
- During AT..... 5-44
- During SP ramp..... 5-44

-E-

- EV display setup..... 5-74
- Event output..... 2-1
- Event..... 5-38
- External dimensions..... 3-2
- External disturbance..... 5-26
- External resistors..... 4-8

-F-

- Fixed length continuous data read..... 7-8
- Fixed length continuous data write..... 7-9
- Fixed length random data read..... 7-10
- Fixed length random data write..... 7-11
- Fixed PID..... 5-10

-G-

Gain adjustment	11-3
Gang-mounting	3-2
Gasket	3-3, 1-3

-H-

Hard cover	1-3, 3-4
Heat/Cool control dead zone	5-15
Heat/Cool control	5-12, 5-15
Heater burnout	5-40
Heater short-circuit	5-40
High function configuration	2-8
Host device	7-1
Hysteresis	5-48

-I-

I/O check	11-2
IEC directive	1-1
Input assign	5-35
Input bit function	5-32, 5-34
Input types	1-1
Installation place	3-1
Integration time	5-14
Internal contact	5-32, 5-33, 5-35
Internal Event Operation type	5-45
Internal Event	5-32
Isolation	13-3

-J-

Just-FiTTER	1-1, 5-20
-------------------	-----------

-K-

Key lock	5-80
Key operation type	5-70

-L-

Latch	5-57
Line filter	4-9
Loader connector	1-5
Loader lock	5-80
Local SP	5-27
Loop diagnosis	5-41, 5-42, 5-43
Lower display	1-5, 2-3, 2-5
L-shaped plug adaptor	1-3
LSP	5-27, 5-28
LSP system group	5-27, 5-28

-M-

Main setting	5-48
Maintenance	10-1
MANUAL	5-44
Master station	7-1
Message Structure	7-3
MODBUS ASCII	8-3
MODBUS communications	8-1
MODBUS RTU	8-4
MODE display setup	5-71
Mode indicators	1-5
[mode] key function	5-70
[mode] key operating procedures	2-7
Model selection table	1-2
Mounting bracket	3-3
Mounting procedures	3-3
MV display setup	5-73
MV high limit	5-40
MV high/low limit	5-40
MV low limit	5-40
MV process	5-52
MV	5-14

-N-

Noise Preventive Measures	4-9
Number of connectable units	4-7, 4-8
Numeric representation	7-13

-O-

OFF delay	5-49
ON delay	5-49
ON/OFF control	5-9, 5-13
Operation Modes	2-9
Optional parts	1-3
Output assign	5-54
Output at PV alarm	5-12
Output at READY	5-12
Output operation at changing Auto/Manual	5-13
Output range	5-66
Output scaling	5-67
Output type	5-66
Over-voltage category	13-4

-P-

Panel mount type	1-2, 3-2
Password	5-81
Phase angle control	4-2

PID control	5-14
Polarity of function	5-36, 5-57
Polarity of input assign	5-36
Polarity of output assign	5-56
Preset MANUAL value	5-13
Proportional band	5-14
PV bias	5-5
PV filter	5-6
PV high limit alarm	5-6
PV high limit	5-6
PV high limit	5-39
PV high/low limit	5-39
PV hold	5-6
PV input calibration	11-2
PV input calibration RTD input	11-3
PV input calibration Thermocouple input	11-3
PV input failure	10-2
PV input range high limit	5-5
PV input range low limit	5-5
PV input range type	5-1, 5-2
PV input	2-1, 5-1
PV low limit alarm	5-6
PV low limit	5-6
PV low limit	5-39
PV range table	5-2
PV ratio	5-5
PV square root extraction	5-1
PV square root extraction dropout	5-3
PV/SP display setup	5-72

-R-

RationalLOOP	1-1, 5-20
RD command	7-8
Read command	8-6
READY	5-44
Reception and transmission timing	7-15
Relay independent contact	4-3
Release all DO latches	5-8
Remote SP	5-27
Resistor type	4-8
Response monitor time	7-15
Response start conditions	7-3
RS command	7-6
RS command	7-6
RS-485 driver control timing	7-15
RTD	5-1

RU command	7-10
RU command	7-10
RUN/READY mode	5-7

-S-

Sample program	7-16
Sampling cycle	13-1
Scaling	5-1
Self-tuning	5-17
Sensor type	5-2
Simple configuration	2-1
Socket mount type	1-2, 3-2
Socket part	1-6
Socket	1-3, 3-2
Soft cover	1-3, 3-5
SP down ramp	5-30
SP high limit	5-27, 5-30
SP high limit	5-40
SP high/low limit	5-40
SP lag	5-20
SP low limit	5-27, 5-30
SP low limit	5-40
SP ramp	5-27, 5-30
SP up ramp	5-30
SP	5-27
Special OFF setup	5-47
Special type	2-2, 2-4
SSR	4-7
ST	5-10
ST (Self-tuning) Function	5-24
ST (Self-tuning) Function	5-24
ST hunting settling width	5-17
ST settling wait	5-44
ST start	5-25
ST step execution resolution width	5-17
ST step ramp change	5-17
ST step settling width	5-17
Stand-alone mounting	3-2
Standard type	2-2
Station address	7-1, 7-4
Stopper	3-2
Sub setting	5-48
Sub-address	7-3, 7-4

-T-

Temperature unit	5-1, 5-3
------------------	----------

Terminal assignment label	4-2
Terminal cover	1-3, 4-2
Terminal part	1-6
Terminating resistor.....	4-2, 4-6
Termination code	7-14
Thermocouple	5-1
Tightening torque.....	13-4
Time proportional cycle mode	5-52
Time proportional cycle	5-52
Timer remain time display setup	5-74
Timer	5-44
Transition	2-9
Transmission speed	7-1
Transmission start time.....	7-15

-U-

Upper display	1-5, 2-3, 2-5
User function.....	5-76
User level	2-8, 5-75

-V-

Voltage between terminals.....	4-7
--------------------------------	-----

-W-

Waterproof mounting.....	3-3
WD command	7-9
WD command	7-9
Word address	7-3, 7-12, 8-11
Write command (10H).....	8-8
WS command.....	7-7
WS command.....	7-7
WU command	7-11
WU command	7-11

Revision History

Printed Date	Manual Number	Edition	Revised pages	Description
03-11	CP-SP-1148E	1st Edition		
04-09		2nd Edition	1-6, 4-2 5-2 5-26 5-34, 6-17,6-18 5-40, 5-41 7-4 13-1 13-4	<p>The tightening torque of the terminal screw 0.4N•m→0.4 to 0.6N•m changed.</p> <p>Handling Precautions 1 item added.</p> <p>●When PV alarm occurrence and recovery are frequently repeated: added.</p> <p>Event channel def. Contents corrected.</p> <p>0:Invalid→Every Internal Event 1 to 5: Internal Event number added.</p> <p>Operation type Heater 1(2) burnout/Over-current Heater 1(2) short- circuit, an annotation(*) added.</p> <p>●List of data link layer data definitions Sub-address Character code "00"(30H, 30H) corrected.</p> <p>•Resistance temperature detector(RTD) input Allowable wiring resistance and Influence of wiring resistance added.</p> <p>•DC voltage input Input impedanse added.</p> <p>●Other specifications Over-voltage category EN664-1→IEC60664-4 changed</p>

YAMATAKE

Yamatake Corporation
Advanced Automation Company

Totate International Building
2-12-19 Shibuya Shibuya-ku
Tokyo 150-8316 Japan
URL: <http://www.yamatake.com>

This has been printed on recycled paper. (02)

Specifications are subject to change without notice.

Printed in Japan.
1st Edition: Issued in Nov., 2003(A)
2nd Edition: Issued in Sep., 2004(E)