

### 1/16 DIN Timer with Easy-to-use Functions

- Nine output modes accommodate a wide variety of applications.
- All parameters set by scroll-through menus accessed from the front panel.
- Field-selectable time ranges from 0.001 second to 9999 hours.
- High visibility LCD display with built-in backlight.
- Precision control possible to 0.001 second.
- Four levels of key protection provided.
- Selectable elapsed time (UP) and remaining time (DOWN) display.
- Model H5CR-S only 64 mm deep.
- Conforms to EMC standards.
- Six-language instruction manual provided.



### Ordering Information

Functions		9 field selectable					
Contact type		SPDT relay			Solid-state open collector		
Unit Depth		Basic (78 mm)	Standard (100 mm)	Short body (64 mm)	Basic (78 mm)	Standard (100 mm)	Short body (64 mm)
Display	Backlit	---	H5CR-B	H5CR-S	---	H5CR-BS	H5CR-SS
	Not backlit	H5CR-L	---	---	H5CR-LS	---	---
Supply voltages	AC	24/100 to 240 V, 50/60 Hz	24/100 to 240 V, 50/60 Hz	---	24/100 to 240 V, 50/60 Hz	24/100 to 240 V, 50/60 Hz	---
	DC	12 to 24 V	---	12 to 24 V	12 to 24 V	---	12 to 24 V

**Note:** Add the supply voltage to the part number when ordering.

#### ■ Model Legend

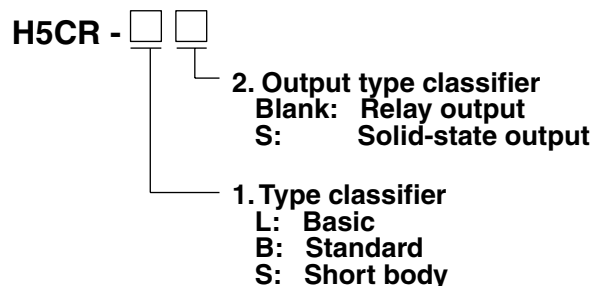

**Note:** Models with a finger safe terminal cover can be ordered by adding "-500" to the end of the model number. (Except for H5CR-L□)  
 e.g., H5CR-B-500 (100 to 240 VDC, 50/60 Hz)  
 The finger safe terminal cover provides finger protection conforming to VDE0106/P100.

## ■ Accessories (Order Separately)

Name		Model
Hard cover		Y92A-48
Soft cover		Y92A-48F1
Track Mounting/Front Connecting Socket (for H5CR-L□ only)	---	P2CF-08
	Finger safe type	P2CF-08-E
Back Connecting Socket (for H5CR-L□ only)	---	P3G-08
	Finger safe type	P3G-08 with Y92A-48G (see note 1)
Finger Safe Terminal Cover for H5CR-B□/-S□		Y92A-48T
Flush Mounting Adapter (see note 2)		Y92F-30

- Note:**
1. Y92A-48G is a finger safe terminal cover which is attached to the P3G-08 Socket.
  2. Supplied with each Unit.

## Specifications

Model	H5CR-L (Basic type)	H5CR-B (Standard type)	H5CR-S (Short body type)
<b>Classification</b>	Digital timer		
<b>Mounting</b>	Flush or Surface mounting	Flush mounting	
<b>External connections</b>	8P socket	Screw terminals (M3.5 screw)	
<b>Enclosure ratings</b>	IP40	IP54 (panel surface)	
<b>Display modes</b>	Elapsed time (UP), remaining time (DOWN)		
<b>Output modes</b>	A, A-1, A-2, A-3, b, b-1, d, E, F		
<b>Reset system</b>	Power reset (except A-3, b-1, and F modes), External, manual, automatic resets (internal according to A-1, b, b-1, d, and E mode operation)		
<b>Input signals</b>	Start, reset inputs	Start, reset, gate, key protect inputs	
<b>Input method</b>	No-voltage input: Via opening and closing of contact		
<b>Control outputs</b>	SPDT contact output and transistor output (NPN open collector)		
<b>Display</b>	LCD without backlight	LCD with backlight	
<b>Digits</b>	4 digits		
<b>Max. time settings</b>	9.999 s (0.001 s units), 99.99 s (0.01 s units), 999.9 s (0.1 s unit), 9999 s (1 s unit), 99 min 59 s (1 s unit), 999.9 min (0.1 min unit), 9999 min (1 min unit), 99 hr 59 min (1 min unit), 999.9 hr (0.1 hr unit), 9999 hr (1 hr unit)		
<b>Memory backup</b>	Backup time for power interruption: Approx. 10 years at 20°C		
<b>Mounting method</b>	DIN track mounting, surface mounting, and flush mounting	Flush mounting	
<b>Approved standards</b>	UL508, CSA C22.2 No. 14 Conforms to EN61010-1		

## ■ Ratings

Model	H5CR-L (Basic type)	H5CR-B (Standard type)	H5CR-S (Short body type)
Rated supply voltage	100 to 240 VAC (50/60 Hz) 24 VAC (50/60 Hz) 12 to 24 VDC (permissible ripple: 20% max.)	100 to 240 VAC (50/60 Hz) 24 VAC (50/60 Hz)	12 to 24 VDC (permissible ripple: 20% max.)
Operating voltage range	85% to 110% of rated voltage		
Power consumption	Approx. 3 VA at 50 Hz, 240 VAC; approx. 1 W at 24 VDC	Approx. 5 VA at 50 Hz, 240 VAC	Approx. 2 W at 24 VDC
Reset and control signals	Min. pulse width 1 ms/20ms selectable		
Gate	---	Min. pulse width: Approx. 20 ms	
Key protect	---	Response time: 1 s	
One-shot time	0.1 to 20 s (select from 7 kinds) or sustained		
Power reset (except A-3, b-1, and F mode)	Min. power opening time: 0.5 s		
Signal, reset, gate inputs	No-voltage input ON impedance: 1 k $\Omega$ max. (Approx. 2 mA when 0 $\Omega$ ) ON residual voltage: 2 V max. OFF impedance: 100 k $\Omega$ min.		
Key protect input	---	No-voltage input ON impedance: 1 k $\Omega$ max. (Approx. 2 mA when 0 $\Omega$ ) ON residual voltage: 1 V max. OFF impedance: 100 k $\Omega$ min.	
Control outputs	Contacts: 5 A at 250 VAC, resistance load ( $\cos \phi = 1$ ) Transistor output: Open collector 100mA at 30 VDC max. residual voltage 2 V max. (Approx. 1 V)		
Ambient temperature	-10°C to 55°C (with no icing)		
Storage temperature	-25°C to 65°C (with no icing)		
Ambient humidity	35% to 85%		
Case	Light gray		

## ■ Characteristics

Repeat accuracy (including temperature and voltage effects)	Power start: $\pm 0.01\% \pm 0.05$ s max. Control signal start: $\pm 0.005\% \pm 0.03$ s max. *(rate for set value)	
Insulation resistance	100 M $\Omega$ min. (at 500 VDC) (between current-carrying terminal and exposed non-current-carrying metal parts, and between non-continuous contacts)	
Dielectric strength	2,000 VAC, 50/60 Hz for 1 min (between current-carrying terminal and exposed non-current-carrying metal parts) for 100 to 240 VAC type 1,000 VAC for 24VAC/12 to 24 VDC transistor output type	
Surge voltage	3 kV (between power terminals) for 100 to 240 VAC type, 1 kV for 24 VAC/12 to 24 VDC type 4.5 kV (between current-carrying terminal and exposed non-current-carrying metal parts) for 100 to 240 VAC type, 1.5 kV for 24 VAC/12 to 24 VDC type	
Noise immunity	$\pm 2$ kV (between power terminals)( $\pm 480$ V for 12 to 24 VDC) and $\pm 600$ V (between input terminals), square-wave noise by noise simulator (pulse width: 100 ns/1 $\mu$ s, 1-ns rise)	
Static immunity	Malfunction: 8 kV; destruction: 15 kV	
Vibration	Destruction	10 to 55 Hz with 0.75-mm single amplitude each in three directions
	Malfunction	10 to 55 Hz with 0.5-mm single amplitude each in three directions
Shock	Destruction	294 m/s <sup>2</sup> (30G) each in three directions
	Malfunction	98 m/s <sup>2</sup> (10G) each in three directions
Life expectancy	Mechanical	10 million operations min.
	Electrical	100,000 operations min. (5 A at 250 VAC in load resistance)
EMC	(EMI): EN50081-2 Emission Enclosure: EN55011 Group 1 class A Emission AC Mains: EN55011 Group 1 class A (EMS): EN50082-2 Immunity ESD: EN61000-4-2: 4 kV contact discharge (level 2) 8 kV air discharge (level 3) Immunity RF-interference: ENV50140: 10 V/m (80 MHz to 1 GHz) (level 3) Immunity Conducted Disturbance: ENV50141: 10 V (0.15 to 80 MHz) (level 3) Immunity Burst: EN61000-4-4: 2 kV power-line (level 3) 2 kV I/O signal-line (level 4)	
Weight	H5CR-L: Approx. 105 g, H5CR-B: Approx. 160 g, H5CR-S: Approx. 120 g	

# Nomenclature

## Display

1. Power indicator
2. Signal input indicator
3. Reset indicator
4. Gate indicator  
(not included in the H5CR-L)
5. Key protection indicator  
(not included in the H5CR-L)
6. Control output indicator
7. Present value  
(character height: 8 mm)  
(Non-significant zeroes suppressed)
8. Set value  
(character height: 4 mm)  
(Indicates value in set function mode)
9. Mode indicator
10. Timing indicator

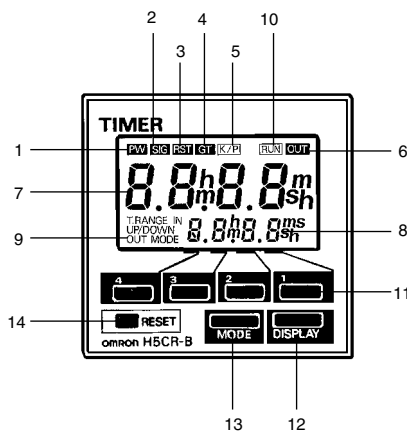

## Operation key

11. Increment keys (1 to 4)  
(Used to change the corresponding digit of the set value. Used to change data in the set mode.)
12. Display key  
(Switches to the present value display.)
13. Mode key  
(Switches from run mode to set mode. Changes items in the set mode.)
14. Reset key  
(Resets timing and outputs.)

## ■ Factory Settings

The following table shows the timer settings when it is shipped. Please change the settings as necessary to suit the system before operation. Settings and the display receive power from the internal battery and are therefore unaffected by external power interruptions.

Model	H5CR-B (Standard)/H5CR-S (Short body)	H5CR-L (Basic)
Time range	- - - s	
Present value	0.00 s	
Presets	0.00 s	
UP/DOWN mode	UP	
Output mode	A: Signal on delay (I)	
Output time	Sustained	
Input signal time	20 ms	
Key protect level	KP-1	---

**Note:** With the initial settings, there will be no output even if the power supply is connected. External inputs and outputs cannot be used without a power supply.

# Operation

## ■ Block Diagram

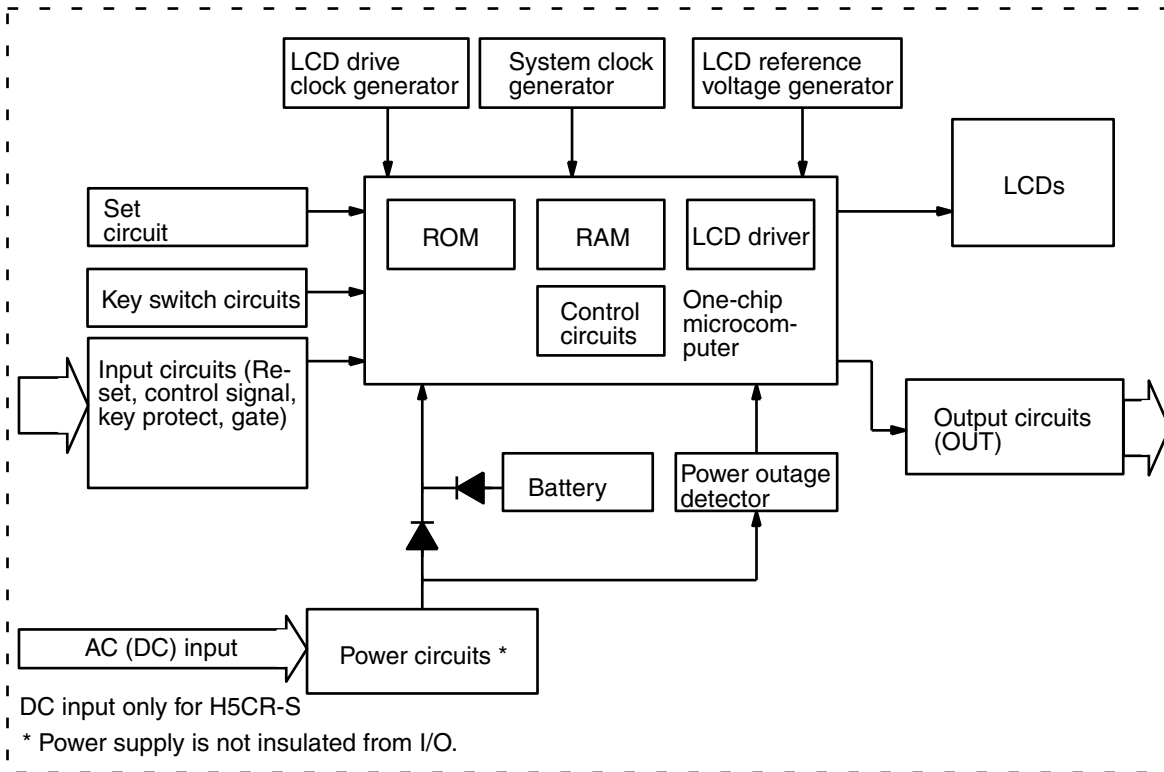

## ■ I/O Functions

<b>Inputs</b>	<b>Start signal</b>	Stops timing in A-2 and A-3 (power on delay) modes. Starts timing in other modes.
	<b>Reset</b>	Resets present value (to zero in UP modes, to preset in DOWN mode). Count inputs are not accepted while reset input is ON. Reset indicator lit while reset input is ON.
	<b>Gate</b>	Inhibits timer operation.
	<b>Key protect</b>	Makes keys inoperative according to key protect level. Key protected indicator lit while key protect input is ON. Effective when power supply is turned off. Effective when protect terminals are shorted.
<b>Outputs</b>	<b>Control output (OUT)</b>	Outputs made according to designated output mode when corresponding preset is reached.

### Operational Overview

This flowchart shows operation common to all H5CR models. Refer to the following Setting Item Table for details on the operation of specific models.

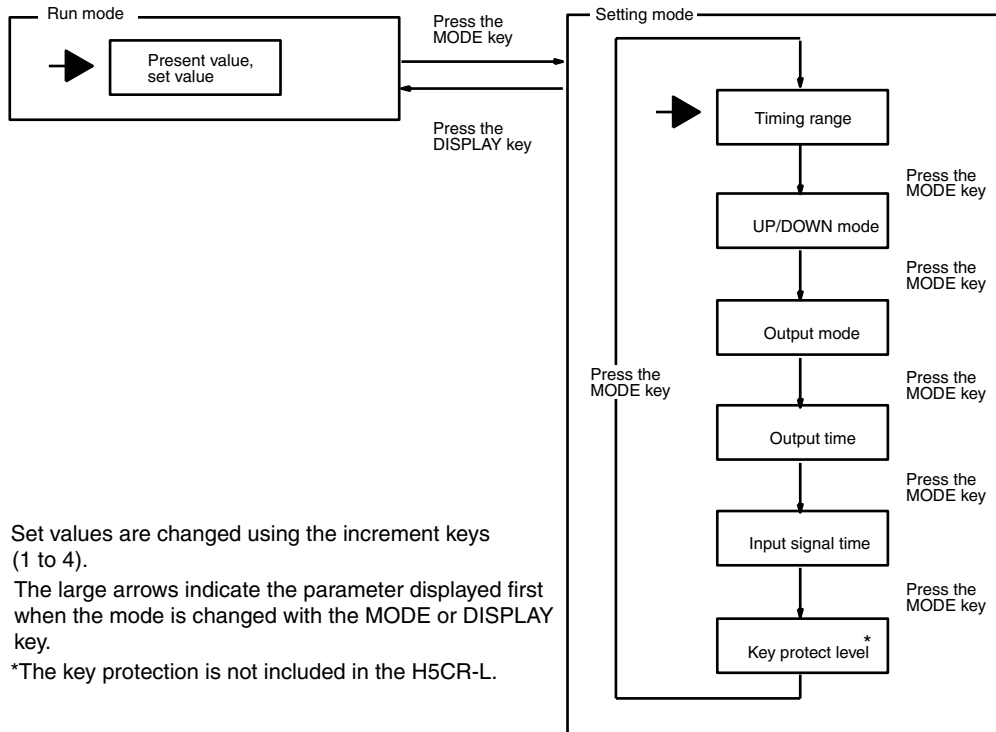

- Note:
1. Set values are changed using the increment keys (1 to 4).
  2. The large arrows indicate the parameter displayed first when the mode is changed with the MODE or DISPLAY key.
  3. \*The key protection is not included in the H5CR-L.

■ Setting Item Table

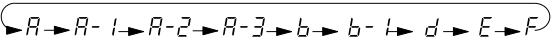
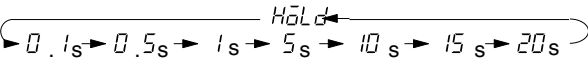
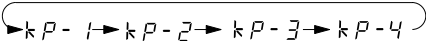
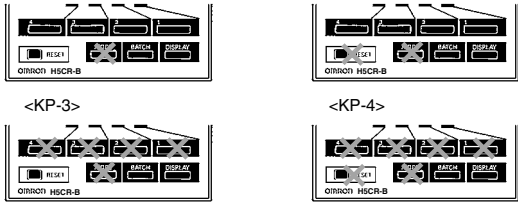
Mode	Setting item	Discription	Setting procedure
Run mode	Set value	Compared to the present value. Determines the timing of the control output according to the output mode.	Sequence when changing a digit using the increment keys (1 to 4). 
Setting mode	Time range*	Determines the timing range.	Change the timing range with the increment keys (1 to 4).
	UP/DOWN mode	Selects	Select UP/DOWN with the increment keys (1 to 4). (UP) $U \leftrightarrow d$ (DOWN)
	Output mode	Determines the form of the control output. (Refer to the present value vs. output diagrams on pages 9 to 11.)	Sequence when changing the mode using the increment keys (1 to 4). 
	Output time	Determines the duration of the control output. Will be displayed when the output mode is A, A-1, A-2, A-3, b, or b-1. Will not be displayed when the output mode is d, E, or F.	Change the output time with the increment keys (1 to 4) 
	Input signal time	Changes the duration of the control and reset input signals.	Change the duration with the increment keys (1 to 4). (1 ms) $1 \leftrightarrow 20$ (20 ms)
	Key protect level	Locks certain keys to prevent accidental operation. The key protection level, kP-1 to kP-4, determines which keys are locked when the key protection input is ON. The locked keys are crossed out in the diagram on the right.	Sequence when changing the key protect level using the increment keys (1 to 4).  

- Note:**
1. Changes made in setting mode become effective when run mode is entered.
  2. The time range setting appears first when setting mode is entered.
  3. \*The key protection function is not included in the H5CR-L.

## Examples

### Run Mode

#### Changing the Set Value

To change the set value from 3 hr 5 min to 4 hr 5 min, press the 3 key so that the number 4 appears in the hour's place.

- Pressing keys 1 through 4 increments the corresponding column by 1.
- The columns can be changed in any order, but the output will be turned ON if the set value is less than the present value.
- Nonsignificant zeros are suppressed on the set value display.

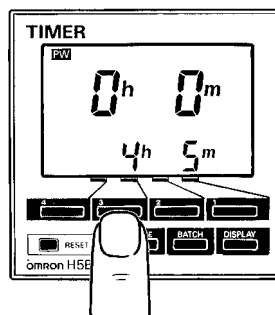

**Note:** Read *Changing Set Values* in the *Precautions* section, page 16, before changing the Timer set value during operation.

### Setting Mode

#### Changing Settings in the Set Mode

1. Press the MODE key to switch from run mode to set mode.
  - The Timer will continue operation if switched from run mode to set mode during operation.
  - The MODE key will be locked if the key protection function is enabled.
  - Settings changed in the set mode are not effective until run mode is entered. As the operating conditions will change in this case, always reset operation with the RESET key or a reset input.
2. Press the MODE key to scroll successively through the items that can be set.

3. Changing the selected item
  - Press the MODE key until the desired item appears.

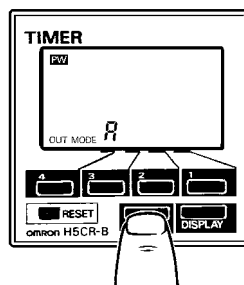

- Change the item setting by pressing keys 1 through 4. (Press the DISPLAY key to switch back from set mode to run mode.)

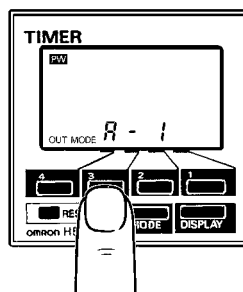
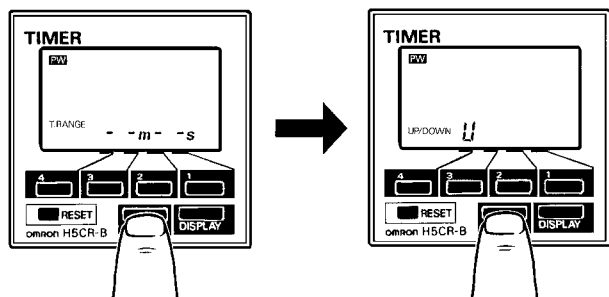



### ■ Timing Charts

The gate input is not included in the H5CR-L.

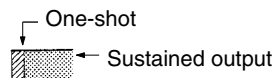

One-shot outputs can be set to 0.1 s, 0.5 s, 1 s, 5 s, 10 s, 20 s.

<b>Output mode A: Signal ON delay 1 (Timer resets when power comes ON.)</b>	
	<p>Timing starts when the start signal goes ON.</p> <p>While the start signal is ON, the timer starts when the power comes ON or when the reset input goes OFF.</p> <p>The control output is controlled using a sustained or one-shot time period.</p> <p><b>Basic Operation</b></p> <p>* Output is instantaneous when setting is 0. ** Start signal input is disabled during timing.</p>
<b>Output mode A-1: Signal ON delay 2 (Timer resets when power comes ON.)</b>	
	<p>Timing starts when the start signal goes ON, and is reset when the start signal goes OFF.</p> <p>While the start signal is ON, the timer starts when the power comes ON or when the reset input goes OFF.</p> <p>The control output is controlled using a sustained or one-shot time period.</p> <p><b>Basic Operation</b></p> <p>*Output is instantaneous when setting is 0.</p>
<b>Output mode A-2: Power ON delay 1 (Timer resets when power comes ON.)</b>	
	<p>Timing starts when the reset input goes OFF.</p> <p>The start signal disables the timing function (i.e., same function as the gate input).</p> <p>The control output is controlled using a sustained or one-shot time period.</p> <p><b>Basic Operation</b></p> <p>*Output is instantaneous when setting is 0.</p>
<b>Output mode A-3: Power ON delay 2 (Timer does not reset when power comes ON.)</b>	
	<p>Timing starts when the reset input goes OFF.</p> <p>The start signal disables the timing function (i.e., same function as the gate input).</p> <p>The control output is controlled using a sustained or one-shot time period.</p> <p><b>Basic Operation</b></p> <p>*Output is instantaneous when setting is 0.</p>

**Output mode b: Repeat cycle 1 (Timer resets when power comes ON.)**

**Sustained Output**

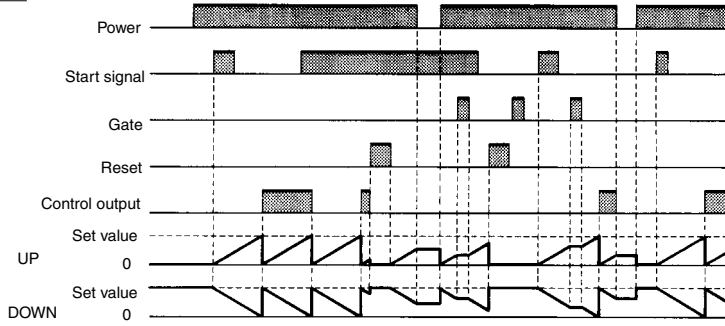

Timing starts when the start signal goes ON.  
The status of the control output is reversed when time is up (OFF at start).  
While the start signal is ON, the timer starts when the power comes ON or when the reset input goes OFF.

**Basic Operation**

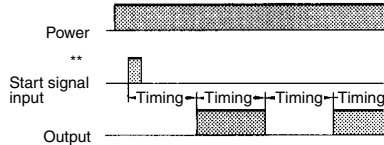

\* Normal output operation will not be possible if the set time is too short. Set the value to at least 100 ms (contact output type).  
\*\* Start signal input is disabled during timing.

**One-shot Output**

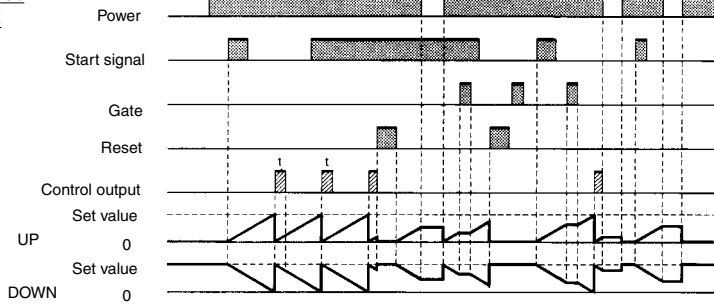

Timing starts when the start signal goes ON.  
The control output is turned ON when time is up.  
While the start signal is ON, the timer starts when the power comes ON or when the reset input goes OFF.

**Basic Operation**

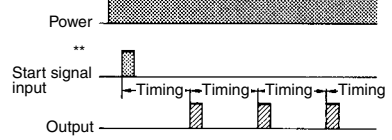

\* Normal output operation will not be possible if the set time is too short. Set the value to at least 100 ms (contact output type).  
\*\* Start signal input is disabled during timing.

**Output mode b-1: Repeat cycle 2 (Timer does not reset when power comes ON.)**

**Sustained Output**



Timing starts when the start signal goes ON.  
The status of the control output is reversed when time is up (OFF at start).  
While the start signal is ON, the timer starts when the power comes ON or when the reset input goes OFF.

**Basic Operation**

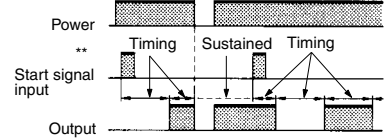

\* Normal output operation will not be possible if the set time is too short. Set the value to at least 100 ms (contact output type).  
\*\* Start signal input is disabled during timing.

**One-shot Output**

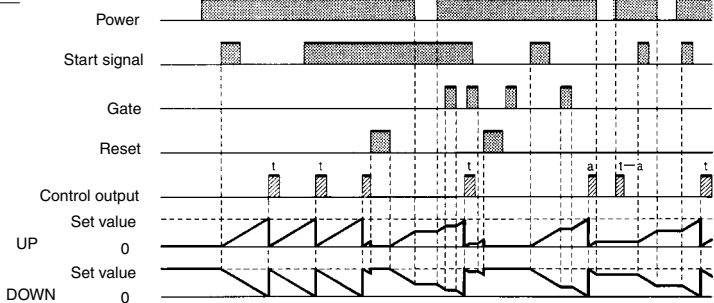

Timing starts when the start signal goes ON.  
The control output comes ON when time is up.  
While the start signal is ON, the timer starts when power comes ON or when the reset input goes OFF.

**Basic Operation**

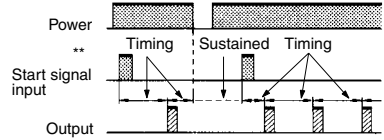

\* Normal output operation will not be possible if the set time is too short. Set the value to at least 100 ms (contact output type).  
\*\* Start signal input is disabled during timing.

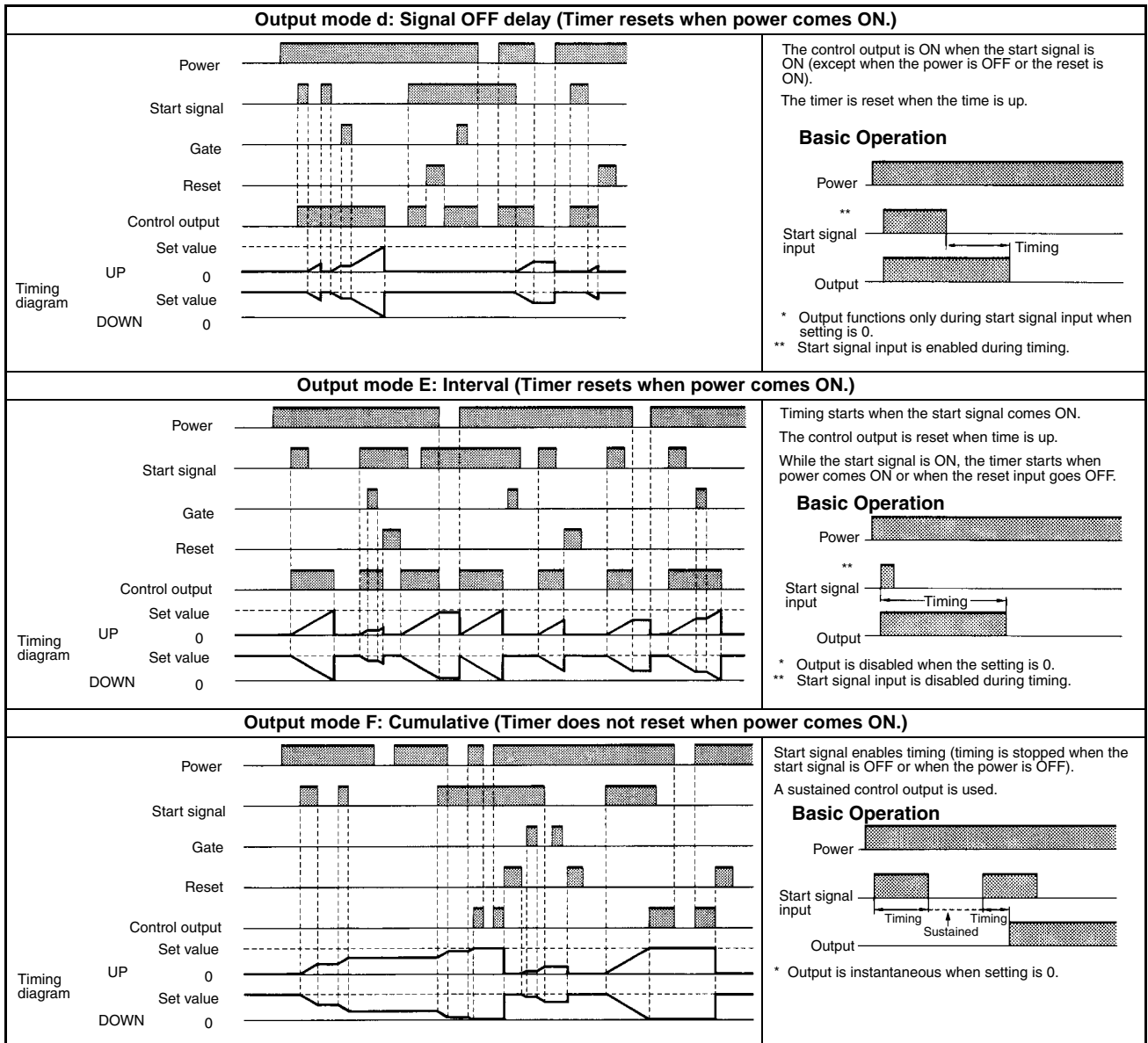

**Note:** A twin timer can be created by using one of the repeat modes. For example, if the set value is 60 s and the one shot time is 10 s in repeat mode, the control output will turn OFF for 50 s and ON for 10 s. (In the first cycle, however, the control output will turn OFF for 60 s.) In this way, the work of two timers can be performed by a single timer.

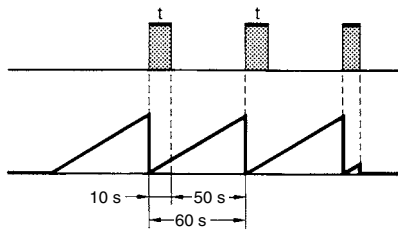

# Dimensions

**Note:** All units are in millimeters unless otherwise indicated.

## H5CR-L

Surface/Flush Mounting

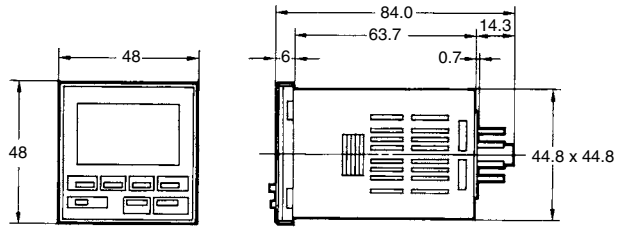
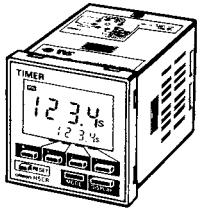

## H5CR-B

Flush Mounting

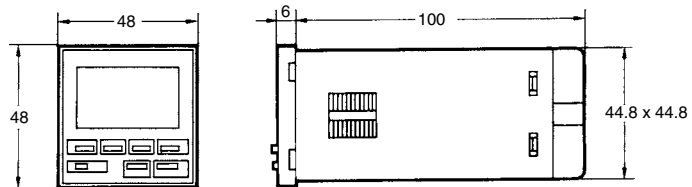
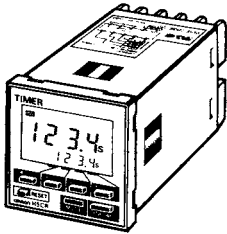

## H5CR-S

Flush Mounting

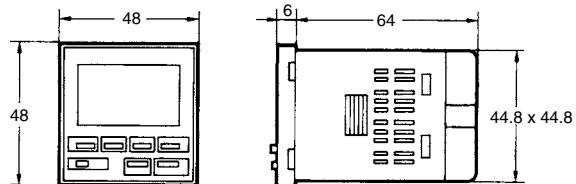
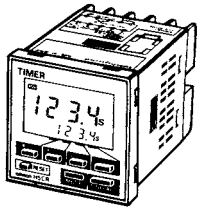

■ Dimensions with Y92F-30 Flush Mounting Adapter

H5CR-L

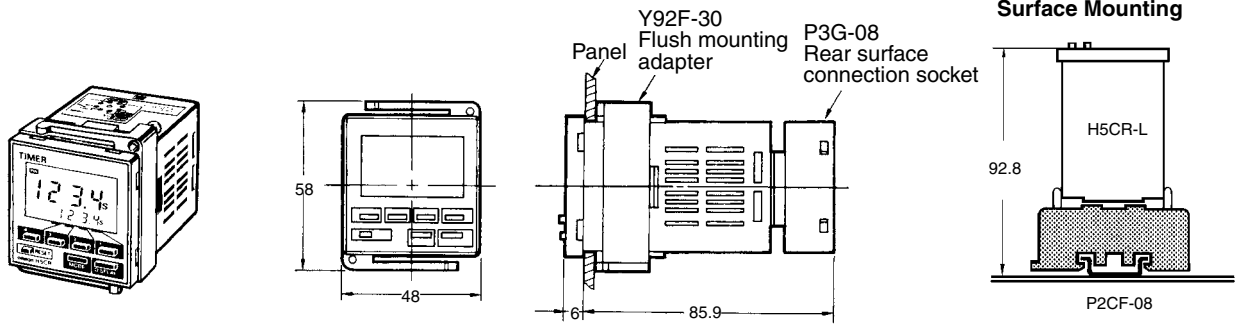

H5CR-B

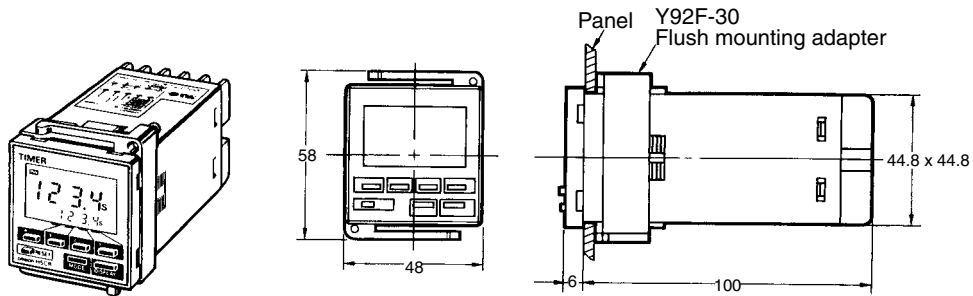

H5CR-S

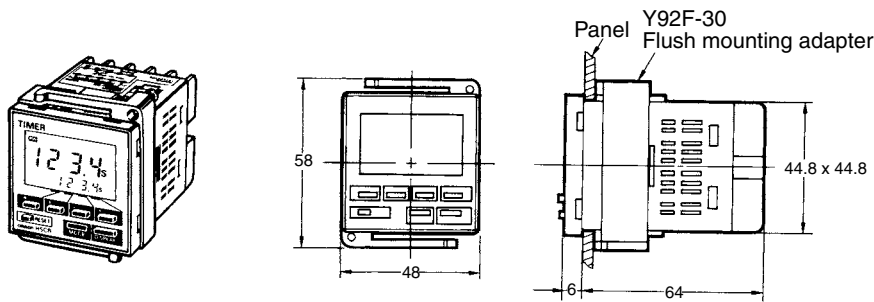

Panel Cutouts

Panel cutouts are as shown below. (according to DIN43700).

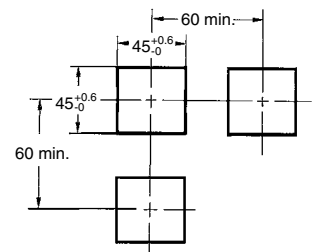

- Note
1. The mounting panel thickness should be 1 to 4 mm.
  2. It is possible to mount timers side by side, but only horizontally.

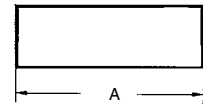

With Y92A-48F1 attached.

$$A = \{48n - 2.5 + (n-1) \times 4\}_0^{+1}$$

With Y92A-48 attached.

$$A = \{51n - 5.5\}_0^{+1}$$

■ Accessories (Order Separately)

**Track Mounting/Front Connecting Socket**

**P2CF-08**

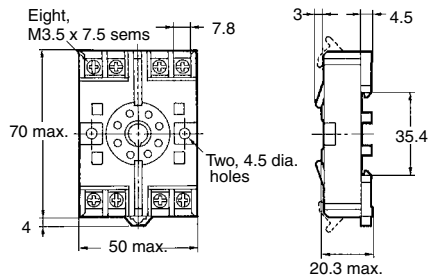
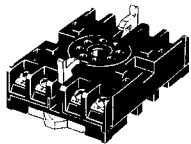

**Terminal Arrangement/  
Internal Connections  
(Top View)**

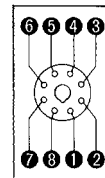

**Surface Mounting Holes**

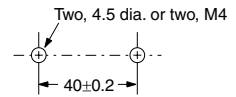

**P2CF-08-E (Finger Safe Terminal Type)**

Conforming to VDE0106/P100

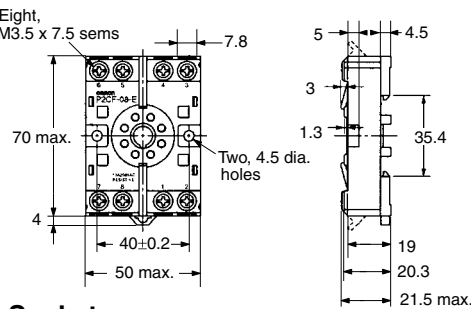
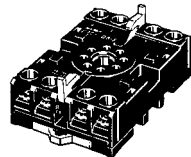

**Terminal Arrangement/  
Internal Connections  
(Bottom View)**

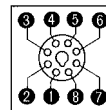

**Back Connecting Socket**

**P3G-08**

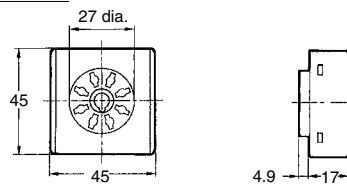
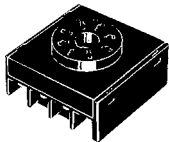

**Terminal Arrangement/  
Internal Connections  
(Bottom View)**

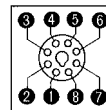

**Finger Safe Terminal Cover**

Conforming to VDE0106/P100

**Y92A-48G**

(Attachment for P3G-08 Socket)

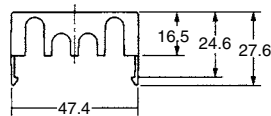
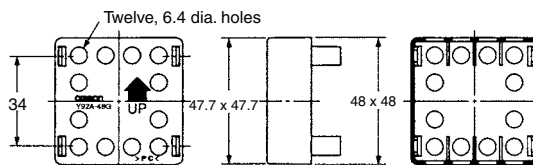
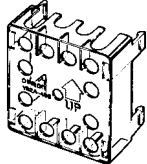

**Y92A-48T**

(Attachment for H5CR-B□/-S□)

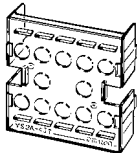

**Hard Cover**

**Y92A-48**

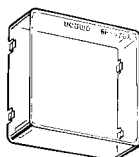

**Soft Cover**

**Y92A-48F1**

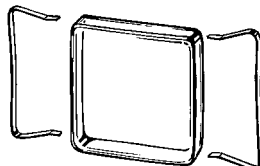

# Installation

## ■ Terminal Arrangement

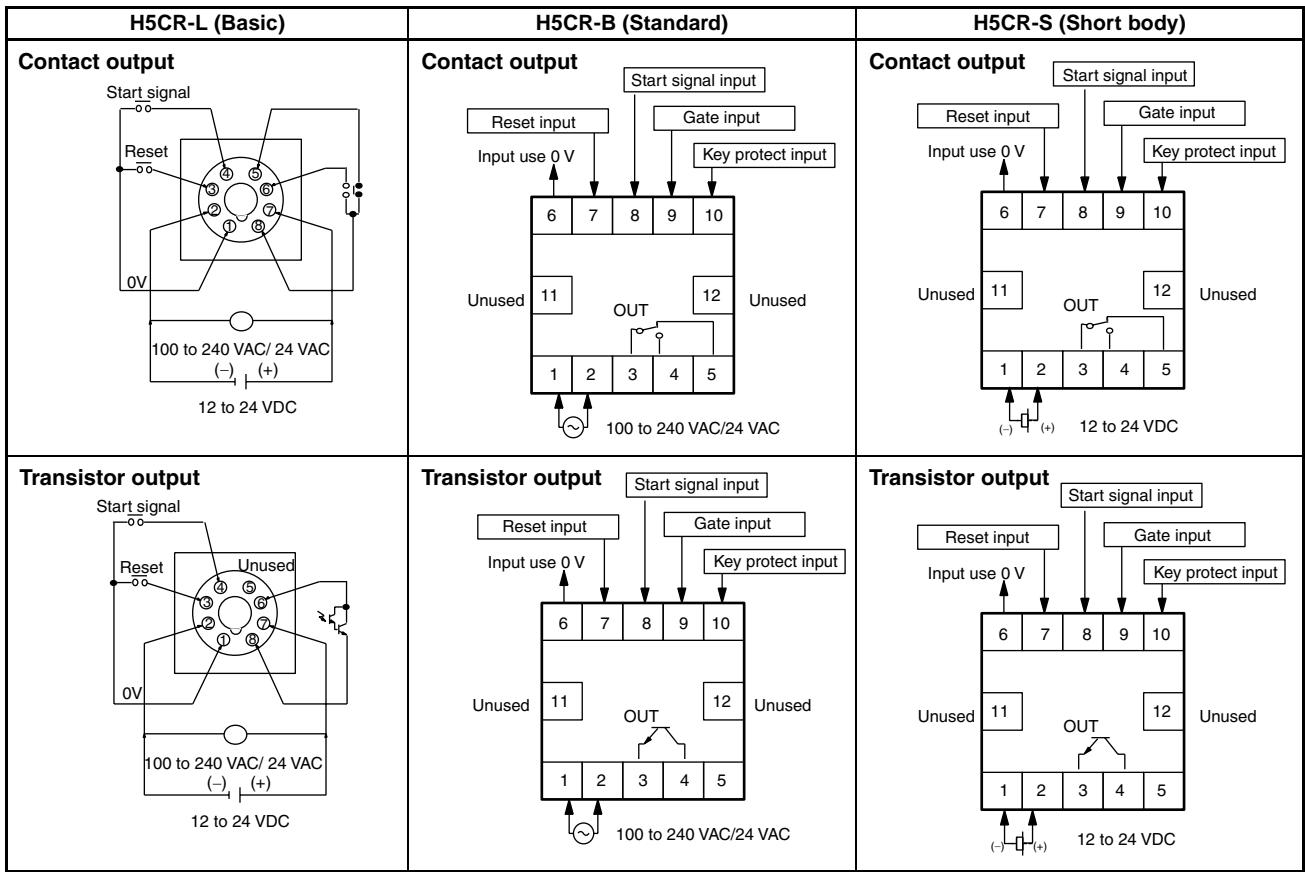

**Note:** Do not connect unused terminals.

## ■ Connections

The inputs of the H5CR are no-voltage (short circuit or open) inputs.

### No-contact Input (NPN Transistor)

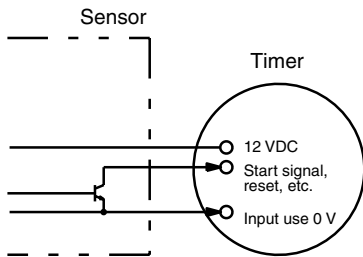

High: transistor ON

### Contact Input

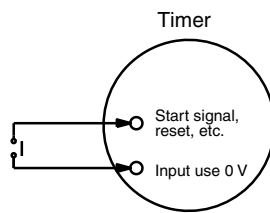

High: contact ON

### No-contact Input

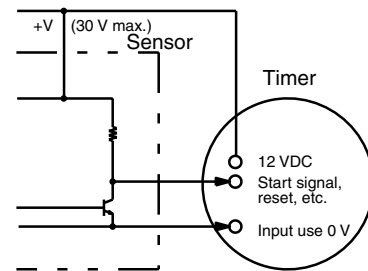

High: transistor ON

### No-voltage Input Signal Levels

No-contact input	1. High level Transistor ON Residual voltage: 2 V max. Impedance when ON: 1 kΩ max.
	2. Low level Transistor OFF Impedance when OFF: 100 kΩ min.
Contact input	Use contacts which can adequately switch 2 mA at 5 V

## Precautions

### ■ Power Supplies

- The input circuit is not insulated from the power supply circuit. The internal circuit might be damaged by a surrounding AC circuit, so use an insulated AC power supply with equipment connected to the input circuit.
- If power is interrupted for less than 10 ms, operation will continue normally. If power is interrupted for between 10 and 500 ms, operation will be inconsistent, and timing may stop or reset, depending on the mode.
- Connect the power supply voltage through a relay or switch in such a way that the voltage reaches a fixed value immediately.
- Depending on switching frequency, current surges may degrade relay contacts; relays with a capacity greater than 10 A are recommended.

### ■ Input and Output

- Do not use external sources to increase the voltage of input signals (control signal, reset, gate, and key protection).
- Be sure that the load of the control output (contact, transistor) is less than the maximum values indicated in the specifications. If the output load exceeds the recommended value, the life span of the contact output type will be shortened dramatically, and the transistor of the transistor output type will be damaged.
- The transistor output is insulated from the internal circuitry by a photocoupler, so either NPN or PNP transistors can be used.

### ■ Self-diagnostic Function

- The following displays will appear if an error occurs. The present value and output enter the same status as after pressing the RESET key.

Display	Error	Output status	Correction	Set
E1	CPU	OFF	Press RESET key	No change
E2	Memory			Set at the factory

### ■ Changing Set Values

- The Timer set value can be changed while the timer is operating, so a high value can be set temporarily to inactivate the timer, or a low value can be set to activate the timer more quickly. (If the set value is changed accidentally during operation, the timer might be activated. Therefore, turn the key protection input ON unless the set value is being changed.)
- To avoid changing the output when changing the set value, it is recommended to begin changing the set value by entering a larger number in the higher digit.

### ■ Operation with a Set Value of 0

- Operation with a set value of 0 will vary depending on the output mode. For details, refer to *Timing Charts*.

### ■ Operating Environment

- When using the Timer in an area with much electronic noise, separate the Timer, wiring, and the equipment which generates the input signals as far as possible from the noise sources. It is also recommended to shield the input signal wiring to prevent electronic interference.
- Organic solvents (such as paint thinner), as well as very acidic or basic solutions might damage the outer casing of the Timer.

### ■ Other

- When the Timer is installed in a control box and tests are conducted which may damage the Timer's internal circuitry (for example, a test measuring the maximum voltage difference between the control circuit and metal components), remove the Timer from the control box or short circuit the terminals.

#### ⚠ Caution

This product contains a lithium battery. Lithium batteries explode if incinerated. Dispose of the Digital Timer as a non-combustible item.

**ALL DIMENSIONS SHOWN ARE IN MILLIMETERS.**

To convert millimeters into inches, multiply by 0.03937. To convert grams into ounces, multiply by 0.03527.

Cat. No. L035-E1-4B **In the interest of product improvement, specifications are subject to change without notice.**

## OMRON Corporation

Industrial Automation Company

Measuring and Supervisory Controls Department  
Shiohara, Shimogyo-ku  
Kyoto, 600-8530 Japan  
Tel: (81)75-344-7108/Fax: (81)75-344-7189

Printed in Japan  
0401-1.5C