

# Operating Instructions

## Memosens COS81D

Hygienic, optical sensor for measuring oxygen







## Table of contents









<b>1</b>	<b>About this document</b> .....	<b>4</b>	10.3	Cleaning the exterior of the sensor .....	29
1.1	Warnings .....	4	10.4	Cleaning the sensor optics .....	29
1.2	Symbols .....	4	10.5	Wear parts and consumables .....	30
<b>2</b>	<b>Basic safety instructions</b> .....	<b>5</b>	10.6	Checking the measurement function .....	33
2.1	Requirements for personnel .....	5	<b>11</b>	<b>Accessories</b> .....	<b>34</b>
2.2	Designated use .....	5	11.1	Assemblies (selection) .....	34
2.3	Workplace safety .....	5	11.2	Measuring cable .....	35
2.4	Operational safety .....	6	11.3	Zero-point gel .....	35
2.5	Product safety .....	6	<b>12</b>	<b>Repair</b> .....	<b>36</b>
<b>3</b>	<b>Device description, function</b> .....	<b>8</b>	12.1	Spare parts and consumables .....	36
3.1	Optical measuring principle .....	8	12.2	Return .....	36
3.2	Sensor design .....	9	12.3	Disposal .....	36
3.3	Memosens technology .....	9	<b>13</b>	<b>Technical data</b> .....	<b>37</b>
3.4	Spot cap .....	10	13.1	Input .....	37
3.5	Stabilization time .....	10	13.2	Performance characteristics .....	37
<b>4</b>	<b>Incoming acceptance and product identification</b> .....	<b>11</b>	13.3	Environment .....	37
4.1	Incoming acceptance .....	11	13.4	Process .....	38
4.2	Product identification .....	11	13.5	Mechanical construction .....	38
4.3	Scope of delivery .....	12	<b>14</b>	<b>Appendices</b> .....	<b>41</b>
4.4	Certificates and approvals .....	12	<b>Index</b> .....	<b>42</b>	
<b>5</b>	<b>Installation</b> .....	<b>15</b>			
5.1	Installation conditions .....	15			
5.2	Mounting the sensor .....	16			
5.3	Installation examples .....	17			
5.4	Post-installation checks .....	20			
<b>6</b>	<b>Electrical connection</b> .....	<b>21</b>			
6.1	Connecting the sensor .....	21			
6.2	Ensuring the degree of protection .....	21			
6.3	Post-connection check .....	21			
<b>7</b>	<b>Calibration and adjustment</b> .....	<b>22</b>			
7.1	Types of calibration .....	22			
7.2	Zero point calibration .....	22			
7.3	Calibration in oxygen with 100% rH .....	23			
7.4	Calculation example for the calibration value ..	23			
<b>8</b>	<b>Commissioning</b> .....	<b>26</b>			
<b>9</b>	<b>Troubleshooting</b> .....	<b>27</b>			
<b>10</b>	<b>Maintenance</b> .....	<b>28</b>			
10.1	Maintenance schedule .....	28			
10.2	Maintenance work .....	28			

# 1 About this document



## 1.1 Warnings

Structure of information	Meaning
 <b>DANGER</b> <b>Causes (/consequences)</b> If necessary, Consequences of non-compliance (if applicable) ▶ Corrective action	This symbol alerts you to a dangerous situation. Failure to avoid the dangerous situation <b>will</b> result in a fatal or serious injury.
 <b>WARNING</b> <b>Causes (/consequences)</b> If necessary, Consequences of non-compliance (if applicable) ▶ Corrective action	This symbol alerts you to a dangerous situation. Failure to avoid the dangerous situation <b>can</b> result in a fatal or serious injury.
 <b>CAUTION</b> <b>Causes (/consequences)</b> If necessary, Consequences of non-compliance (if applicable) ▶ Corrective action	This symbol alerts you to a dangerous situation. Failure to avoid this situation can result in minor or more serious injuries.
<b>NOTICE</b> <b>Cause/situation</b> If necessary, Consequences of non-compliance (if applicable) ▶ Action/note	This symbol alerts you to situations which may result in damage to property.

## 1.2 Symbols

	Additional information, tips
	Permitted
	Recommended
	Forbidden or not recommended
	Reference to device documentation
	Reference to page
	Reference to graphic
	Result of a step

### 1.2.1 Symbols on the device

	Reference to device documentation
	Do not dispose of products bearing this marking as unsorted municipal waste. Instead, return them to the manufacturer for disposal under the applicable conditions.

## 2 Basic safety instructions

### 2.1 Requirements for personnel

- Installation, commissioning, operation and maintenance of the measuring system may be carried out only by specially trained technical personnel.
- The technical personnel must be authorized by the plant operator to carry out the specified activities.
- The electrical connection may be performed only by an electrical technician.
- The technical personnel must have read and understood these Operating Instructions and must follow the instructions contained therein.
- Faults at the measuring point may only be rectified by authorized and specially trained personnel.

 Repairs not described in the Operating Instructions provided must be carried out only directly at the manufacturer's site or by the service organization.

### 2.2 Designated use

The sensor is designed for continuous measurement of dissolved oxygen in water and aqueous solutions, and also for continuous measurement of oxygen in gases.

The sensor is particularly suitable for:

- Monitoring inertization equipment in the food industry
- Monitoring, measuring and regulating the oxygen content in chemical processes
- Monitoring of fermentation processes

#### NOTICE

##### Halogen-containing solvents, ketones and toluene

Halogen-containing solvents (dichloromethane, chloroform), ketones (e.g. acetone, pentanone) and toluene have a cross-sensitive effect and result in decreased measured values or, at worst, in the complete failure of the sensor!

- ▶ Use the sensor only in media that are free from halogens, ketones and toluene.

For non-contact digital data transmission, the sensor must be connected to the digital input of the Liquiline transmitter using the CYK10 measuring cable.

Use of the device for any purpose other than that described, poses a threat to the safety of people and of the entire measuring system and is therefore not permitted.

The manufacturer is not liable for damage caused by improper or non-designated use.

### 2.3 Workplace safety

As the user, you are responsible for complying with the following safety conditions:

- Installation guidelines
- Local standards and regulations
- Regulations for explosion protection

##### Electromagnetic compatibility

- The product has been tested for electromagnetic compatibility in accordance with the applicable international standards for industrial applications.
- The electromagnetic compatibility indicated applies only to a product that has been connected in accordance with these Operating Instructions.

## 2.4 Operational safety

### Before commissioning the entire measuring point:

1. Verify that all connections are correct.
2. Ensure that electrical cables and hose connections are undamaged.
3. Do not operate damaged products, and protect them against unintentional operation.
4. Label damaged products as defective.

### During operation:

- ▶ If faults cannot be rectified:  
products must be taken out of service and protected against unintentional operation.

## 2.5 Product safety

### 2.5.1 State of the art

The product is designed to meet state-of-the-art safety requirements, has been tested, and left the factory in a condition in which it is safe to operate. The relevant regulations and international standards have been observed.

### 2.5.2 Electrical equipment in explosive atmospheres

#### ATEX II 1G / IECEx Ex ia IIC T3/T4/T6 Ga

The Memosens inductive sensor cable connection system, consisting of:

- oxygen sensor Oxymax COS81D and
- measuring cable CYK10/CYK20
- A maximum ambient temperature of 90 °C (194 °F) must not be exceeded at the sensor head.
- The certified Oxymax COS81D oxygen sensor, in conjunction with the CYK10 measuring cable, may be connected only to certified, intrinsically safe, digital sensor circuits of the Liquiline M CM42 transmitter. The electrical connection must be made according to the wiring diagram.
- Oxygen sensors for use in the Ex area have a special conductive O-ring. The electrical connection of the metallic sensor shaft to the conductive mounting location (such as a metallic assembly) is via the O-ring.
- You must connect the assembly or the installation location to ground according to the Ex guidelines.
- The sensors must not be operated under electrostatically critical process conditions. Avoid strong steam or dust currents that act directly on the connection system.
- Hazardous area versions of digital sensors with Memosens technology are indicated by a red-orange ring in the plug-in head.
- The maximum permitted cable length between the sensor and transmitter is 100 m (330 ft).
- Full compliance with regulations for electrical systems in hazardous locations (EN/IEC 60079-14) is mandatory when using the devices and sensors.

#### CSA C/ US: Class I, Zone 0 AEx ia IIC T6...T4 Ga and IS Class I, Division 1, Groups A, B, C and D T6...T4

 Pay attention to the XA and control drawing for the transmitter used.

The relevant XA with the control drawing is available in the Download Area of the product page under [www.endress.com](http://www.endress.com).

**Temperature classes ATEX, IECEx, CSA C/ US and NEPSI**

*ATEX II 1G Ex ia IIC T3/T4/T6 Ga*

Type	Medium temperature $T_a$ for temperature class ( $T_n$ )
COS81D - BA****13	-10 °C ≤ $T_a$ ≤ 130 °C (T3) -10 °C ≤ $T_a$ ≤ 120 °C (T4) -10 °C ≤ $T_a$ ≤ 70 °C (T6)
COS81D - BA****33	0 °C ≤ $T_a$ ≤ 130 °C (T3) 0 °C ≤ $T_a$ ≤ 120 °C (T4) 0 °C ≤ $T_a$ ≤ 70 °C (T6)

*IECEx Ex ia IIC T3/T4/T6 Ga*

Type	Medium temperature $T_a$ for temperature class ( $T_n$ )
COS81D - IA****13	-10 °C ≤ $T_a$ ≤ 130 °C (T3) -10 °C ≤ $T_a$ ≤ 120 °C (T4) -10 °C ≤ $T_a$ ≤ 70 °C (T6)
COS81D - IA****33	0 °C ≤ $T_a$ ≤ 130 °C (T3) 0 °C ≤ $T_a$ ≤ 120 °C (T4) 0 °C ≤ $T_a$ ≤ 70 °C (T6)

*CSA C/ US: Class I, Zone 0 AEx ia IIC T6...T4 Ga and IS Class I, Division 1, Groups A, B, C and D T6...T4*

Type	Medium temperature $T_a$ for temperature class ( $T_n$ )
COS81D -C3****13	-10 °C ≤ $T_a$ ≤ 120 °C (T4) -10 °C ≤ $T_a$ ≤ 70 °C (T6)
COS81D - C3****33	0 °C ≤ $T_a$ ≤ 120 °C (T4) 0 °C ≤ $T_a$ ≤ 70 °C (T6)

*NEPSI Ex ia IIC T3/T4/T6 Ga*

Type	Medium temperature $T_a$ for temperature class ( $T_n$ )
COS81D - NA****13	-10 °C ≤ $T_a$ ≤ 130 °C (T3) -10 °C ≤ $T_a$ ≤ 120 °C (T4) -10 °C ≤ $T_a$ ≤ 70 °C (T6)
COS81D - NA****33	0 °C ≤ $T_a$ ≤ 130 °C (T3) 0 °C ≤ $T_a$ ≤ 120 °C (T4) 0 °C ≤ $T_a$ ≤ 70 °C (T6)

## 3 Device description, function

### 3.1 Optical measuring principle

#### Sensor structure

Oxygen-sensitive molecules (markers) are integrated into the optically active layer (luminescence layer).

The luminescence layer, an optical insulating layer and a cover layer are applied on top of one another on the carrier. The cover layer is in direct contact with the medium.

The sensor optics are directed at the rear of the carrier and therefore at the luminescence layer.

#### Measurement process (principle of fluorescence quenching)

If the sensor is immersed in the medium, an equilibrium is very quickly established between the oxygen partial pressure in the medium and the luminescence layer.

1. The sensor optics send orange light pulses to the luminescence layer
2. The markers "respond" (luminesce) with darkred light pulses.
  - ↳ The decay time and intensity of the response signals are directly dependent on the oxygen content and oxygen partial pressure.

If the medium is free from oxygen, the decay time is long and the signal is very intense.

Any oxygen molecules present mask the marker molecules. As a result, the decay time is shorter and the signals are less intense.

#### Measurement result

- ▶ The sensor calculates the measurement result on the basis of the signal intensity and decay time using the Stern-Volmer equation.

The sensor provides measured values for temperature and partial pressure as well as a raw measured value. This value corresponds to the luminescence decay time and is approx. 14  $\mu$ s in air and approx. 56  $\mu$ s in oxygen-free media.

#### For optimum measurement results

1. During calibration, enter the current air pressure at the transmitter.
2. If the measurement is not performed at **Air 100% rh**:  
Enter the current humidity.
3. In the case of saline media:  
Enter the salinity.
4. For measurements in the units %Vol or %SAT:  
Also enter the current operating pressure in the measuring mode.



- Operating Instructions for Memosens, BA01245C  
For all transmitters, analyzers and samplers in the Liquiline CM44x/P/R, Liquiline System CA80XX and Liquistation CSFxx product families
- Operating Instructions for Liquiline CM42, BA00381C and BA00382C



### 3.2 Sensor design

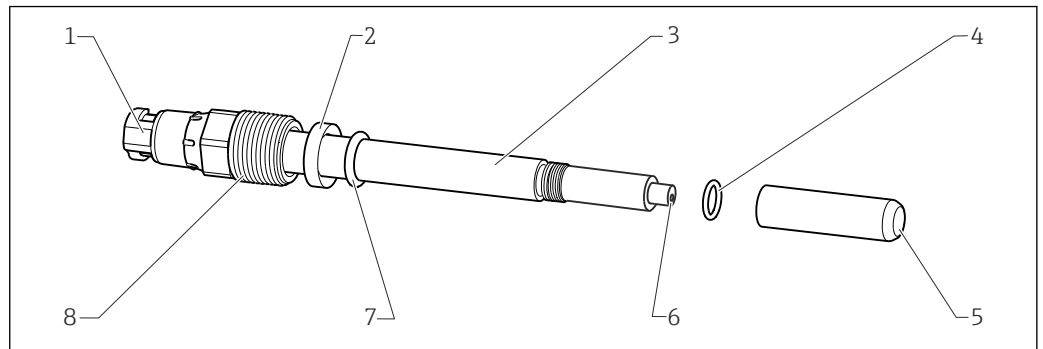

1 Memosens COS81D

- |   |  |   |   |
|---|--|---|---|
| 1 | Memosens plug-in head with optics assembly | 5 | Spot cap                                  |
| 2 | Thrust collar                              | 6 | Optical waveguide with temperature sensor |
| 3 | Sensor shaft                               | 7 | Process seal 10.77 x 2.62 mm              |
| 4 | O-ring sensor shaft                        | 8 | Process connection Pg 13.5                |

**i** The suitability of the selected materials for use in the process must be assessed during the product configuration.

Process conditions that go beyond the resistance range of the materials may shorten the operating life of the materials and make maintenance necessary.

The sensor's spot cap can have either a c-shaped or u-shaped design.

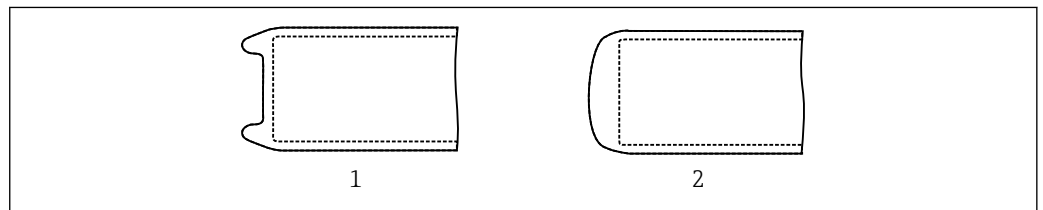

2 Design of spot cap

- |   |          |
|---|----------|
| 1 | u-shaped |
| 2 | c-shaped |

The sensor consists of the following functional units:

- Sensor shaft
- Sensor head with optics (emitter and detector)
- Fluorescence cap
- Protection guard

As an alternative to the standard protection guard, other protection guard models and a cleaning unit can be used. The cleaning unit is suitable for immersion operation.

### 3.3 Memosens technology

Sensors with Memosens protocol have an integrated electronics unit that stores calibration data and other information. Once the sensor has been connected, the sensor data are transferred automatically to the transmitter and used to calculate the measured value.

- ▶ Call up the sensor data via the corresponding DIAG menu.

Digital sensors can store measuring system data in the sensor. These include the following:

- Manufacturer data
  - Serial number
  - Order code
  - Date of manufacture
- Calibration data
  - Calibration date
  - Calibration values
  - Number of calibrations
  - Serial number of the transmitter used to perform the last calibration or adjustment
- Operating data
  - Temperature application range
  - Date of initial commissioning
  - Hours of operation under extreme conditions

### **3.4 Spot cap**

The oxygen dissolved in the medium is diffused to the luminescence layer of the spot cap. A suitable flow is not required, as no oxygen is consumed during measurement. However, flow improves the speed at which the measuring system reacts and ensures a more representative measured value compared to a measurement in a static medium.

The spot is permeable for dissolved gases only. Other substances dissolved in the liquid phase, such as ionic substances, will not penetrate through the membrane. Therefore, medium conductivity has no impact on the measuring signal.

### **3.5 Stabilization time**

The measuring method used by the sensor is temperature-dependent. For this reason, the temperature of the sensor must be adapted to the medium temperature during commissioning. You obtain reliable measured values once a stable temperature value is reached.

The temperature usually adapts very quickly in aqueous media. Temperature adaptation can take several minutes in gaseous media.

## 4 Incoming acceptance and product identification

### 4.1 Incoming acceptance

1. Verify that the packaging is undamaged.
  - ↳ Notify the supplier of any damage to the packaging.  
Keep the damaged packaging until the issue has been resolved.
2. Verify that the contents are undamaged.
  - ↳ Notify the supplier of any damage to the delivery contents.  
Keep the damaged goods until the issue has been resolved.
3. Check that the delivery is complete and nothing is missing.
  - ↳ Compare the shipping documents with your order.
4. Pack the product for storage and transportation in such a way that it is protected against impact and moisture.
  - ↳ The original packaging offers the best protection.  
Make sure to comply with the permitted ambient conditions.

If you have any questions, please contact your supplier or your local Sales Center.

### 4.2 Product identification

#### 4.2.1 Nameplate

The nameplate provides you with the following information on your device:

- Manufacturer identification
  - Order code
  - Extended order code
  - Serial number
  - Safety information and warnings
  - Certificate information
- ▶ Compare the information on the nameplate with the order.

#### 4.2.2 Identifying the product

##### Product page

[www.endress.com/cos81d](http://www.endress.com/cos81d)

##### Interpreting the order code

The order code and serial number of your product can be found in the following locations:

- On the nameplate
- In the delivery papers

##### Obtaining information on the product

1. Go to [www.endress.com](http://www.endress.com).
2. Page search (magnifying glass symbol): Enter valid serial number.
3. Search (magnifying glass).
  - ↳ The product structure is displayed in a popup window.

4. Click the product overview.
  - ↳ A new window opens. Here you fill information pertaining to your device, including the product documentation.

#### **Manufacturer's address**

Endress+Hauser Conducta GmbH+Co. KG  
Dieselstraße 24  
70839 Gerlingen  
Germany

### **4.3 Scope of delivery**

#### **Scope of delivery of sensor**

- Oxygen sensor with protection cap
- Brief Operating Instructions
- Certificate

#### **Scope of delivery of the Memosens COV81 maintenance kit is based on the configuration**

- Spot cap
- O-ring mounting tool
- Cleaning cloth for optics
- O-rings
- Certificate

### **4.4 Certificates and approvals**

A list of all the approvals is provided below. The approvals that are valid for this product depend on the device version ordered.

#### **4.4.1 CE mark**

##### **Declaration of conformity**

The product meets the requirements of the harmonized European standards. As such, it complies with the legal specifications of the EU directives. The manufacturer confirms successful testing of the product by affixing to it the **CE** mark.

#### **4.4.2 EAC**

The product has been certified according to guidelines TP TC 004/2011 and TP TC 020/2011 which apply in the European Economic Area (EEA). The EAC conformity mark is affixed to the product.

#### **4.4.3 Ex approvals**

##### **Version COS81D-BA**

ATEX II 1G Ex ia IIC T3/T4/T6 Ga

##### **Version COS81D-IA**

IECEx Ex ia IIC T3/T4/T6 Ga

##### **Version COS81D-C3**

CSA C/ US Class I, Zone 0 AEx ia IIC T6...T4 Ga and IS Class I, Division 1, Groups A, B, C and D T6...T4

##### **Version COS81D-NA**

NEPSI Ex ia IIC T3/T4/T6 Ga

#### 4.4.4 Certification body Certification center

##### DEKRA Testing and Certification GmbH

Bochum

##### ООО "НАИО ЦСБЭ"

Russian Federation

#### 4.4.5 Material certificates

##### Manufacturer declaration of FDA compatibility

All parts (seals) in contact with the medium comply with the relevant regulations of the U.S. Food and Drug Administration (FDA).

Certified in the FDA Declaration of Conformity and Pharma CoC (→ Product Configurator on the product page)

Product	FDA certificate for
COS81D-*****1	O-rings, process seal, spot layer in contact with medium

##### Hazardous area versions

For operation in FDA processes, another FDA-approved seal must be installed before the process seal (for example CPA442). Doing so will sufficiently separate the process from the Ex connection.

##### Material test certificate

A test certificate 3.1 in accordance with EN 10204 is supplied depending on the version (→ Product Configurator on the product page).

This certificate certifies the traceability of the materials used including the pipe material.

#### 4.4.6 EHEDG

##### COS81D-\*\*\*\*\*1\* only

Compliance with EHEDG's criteria for hygienic design

- Technical University of Munich, Research Center for Brewing and Food Quality, Freising-Weihenstephan
- Certificate type: Type EL Class I

The use of an EHEDG-certified assembly is a prerequisite for the easy-to-clean installation of a 12-mm sensor in accordance with EHEDG requirements. Furthermore, the instructions regarding the hygienic installation and operation of the assembly in the relevant Operating Instructions must be adhered to.

#### 4.4.7 ASME BPE

##### Only COS81D-\*\*\*\*C\*1\*

Designed in accordance with the criteria of ASME (American Society of Mechanical Engineers) BPE (Bioprocessing Equipment)

Ensure a suitable assembly is used.

#### 4.4.8 Regulation (EC) No. 1935/2004

Meets the requirements of Regulation (EC) No. 1935/2004

The sensor therefore meets the requirements for materials that come into contact with food.

#### **4.4.9 Biological reactivity test**

Certificate of Compliance for biological reactivity tests as per USP (United States Pharmacopeia) part<87> and part <88> class VI with batch traceability of materials in contact with product (O-rings, spot layer in contact with medium).

#### **4.4.10 Marine approvals**

A selection of sensors have type approval for marine applications, issued by the following classification societies: ABS (American Bureau of Shipping), BV (Bureau Veritas), DNV-GL (Det Norske Veritas-Germanische Lloyd) and LR (Lloyd's Register). Details of the order codes of the approved sensors, and the installation and ambient conditions, are provided in the relevant certificates for marine applications on the product page on the Internet.

#### **4.4.11 CRN approval**

As the assembly can be operated at a nominal pressure greater than 15 psi (approx. 1 bar), it has been registered according to CSA B51 ("Boiler, pressure vessel, and pressure piping code"; category F) with a CRN (Canadian Registration Number) in all Canadian provinces.

## 5 Installation

### 5.1 Installation conditions

#### 5.1.1 Orientation

##### COS81D-\*\*\*\*C\*\*\* (c-shaped)

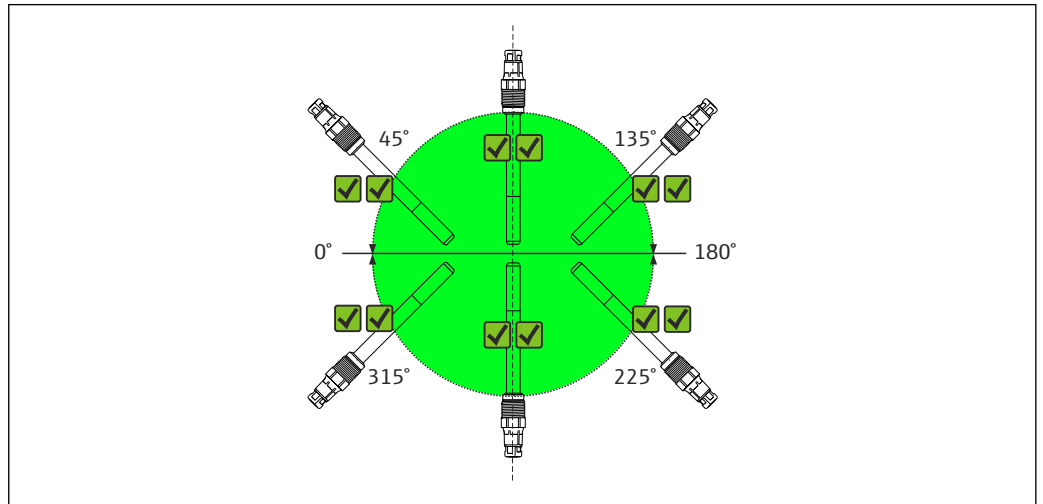

- 3 Installation angle Memosens COS81D-\*\*\*\*C\*\*\* (c-shaped spot cap)  
 The sensor can be installed at any installation angle (0 to 360°).  
 Recommended installation angle

##### COS81D-\*\*\*\*U\*\*\* (u-shaped)

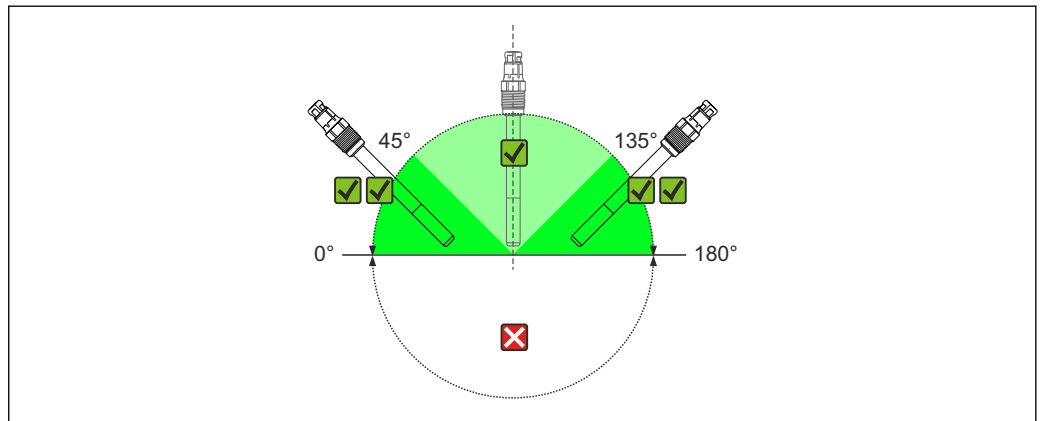

- 4 Installation angle Memosens COS81D-\*\*\*\*U\*\*\* (u-shaped spot cap)  
 Recommended installation angle  
 Possible installation angle  
 Inadmissible installation angle

Install the sensor at an angle of inclination of 10° to 170° of 0° to 180° in an assembly, holder or suitable process connection.

- Recommended angle: 0° to 45° or 135° to 180° to prevent the attachment of air bubbles.
- At angles of inclination of 45° to 135°, air bubbles at the oxygen-sensitive membrane may result in higher readings than expected.

Inclination angles other than those mentioned are not permitted. In order to avoid buildup and condensation on the spot, do **not** install the COS81D-\*\*\*U \*\*\*sensor upside down.



Follow the instructions for installing sensors in the Operating Instructions for the assembly used.

### 5.1.2 Installation location

1. Choose a mounting location that is easy to access.
2. Ensure that upright posts and assemblies are fully secured and vibration-free.
3. Choose a mounting location with an oxygen concentration that is typical for the application.

## 5.2 Mounting the sensor

### 5.2.1 Measuring system

A complete measuring system comprises:

- a Memosens COS81D oxygen sensor
- Measuring cable CYK10
- a transmitter, e.g. Liquiline CM42, Liquiline CM44x/R, Liquiline CM44P, Liquiline Compact CM72/82, Liquiline Mobile CML18
- Optional: an assembly, e.g. permanent installation assembly CPA842, flow assembly or retractable assembly CPA875

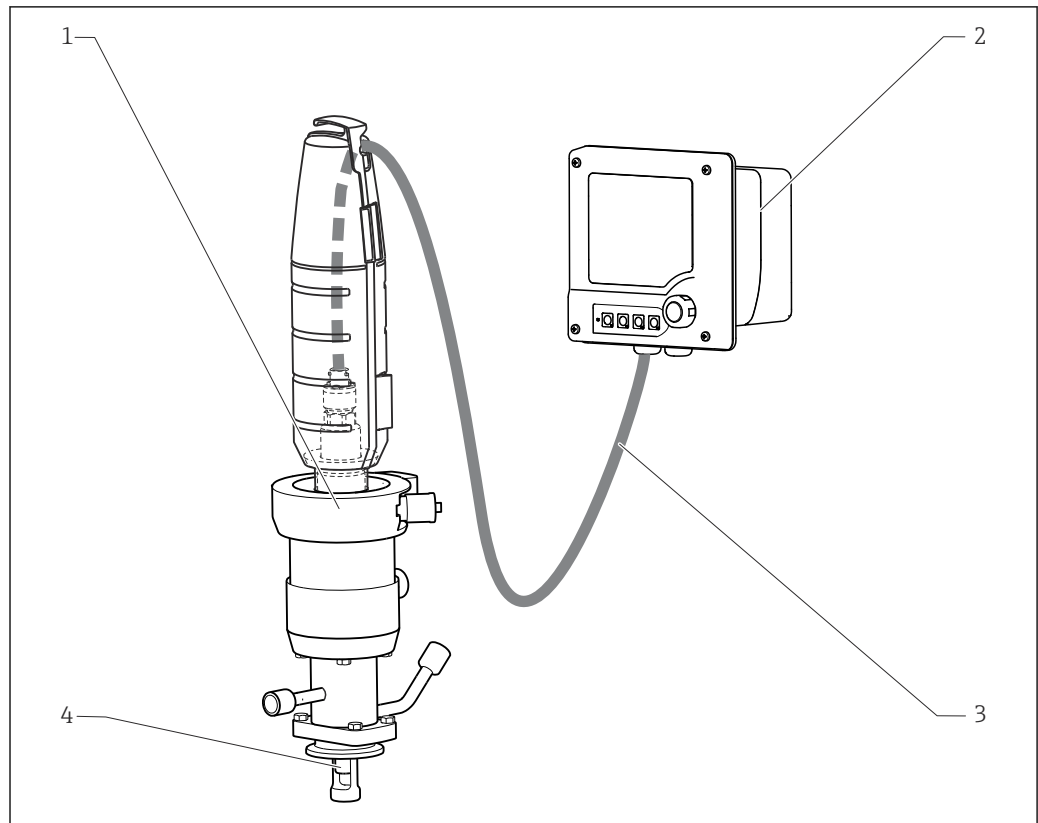

5 Example of a measuring system with Memosens COS81D

- 1 Retractable assembly CPA875
- 2 Liquiline CM42 transmitter
- 3 Measuring cable CYK10
- 4 Memosens COS81D oxygen sensor

A0029064



## 5.2.2 Installing at a measuring point

Must be installed in a suitable assembly (depending on the application).

### WARNING

#### Electrical voltage

In the event of a fault, non-grounded metallic assemblies may be live and as such are not safe to touch!

- ▶ When using metallic assemblies and installation equipment, national grounding provisions must be observed.

For complete installation of a measuring point, proceed as follows:

1. Install the retractable assembly or flow assembly (if used) into the process
2. Connect the water supply to the rinse connections (if you are using an assembly with a cleaning function)
3. Install and connect the oxygen sensor

### NOTICE

#### Installation errors

Cable breakage, loss of sensor due to cable separation, unscrewing of spot cap!

- ▶ Do not install the sensor freely suspended from the cable!
- ▶ Screw the sensor into the assembly, ensuring that the cable is not twisted.
- ▶ Hold the sensor body steady during installation or removal. Turn **only at the hexagonal nut** of the armored coupling. Otherwise the spot cap might be unscrewed. This will then remain in the assembly or process.
- ▶ Avoid exerting excessive tensile force on the cable (e.g. through jerky pulling movements).
- ▶ Choose an installation location that is easy to access for later calibrations.
- ▶ Follow the instructions for installing sensors in the Operating Instructions for the assembly used.

## 5.3 Installation examples

### 5.3.1 Permanent installation (CPA842)

The permanent installation assembly CPA842 enables easy adaptation of a sensor to nearly any process connections from Ingold nozzles to Varivent or Tri-Clamp connections. This kind of installation is very well suited for tanks and larger pipes. This enables a defined immersion depth of the sensor into the medium in the simplest way.

### 5.3.2 Flow assembly

#### Flow assembly CYA680

The flow assembly is available in various nominal diameters and materials. It can be installed both in horizontal and vertical pipes. The assembly can be operated with 1 or 2 sensors.

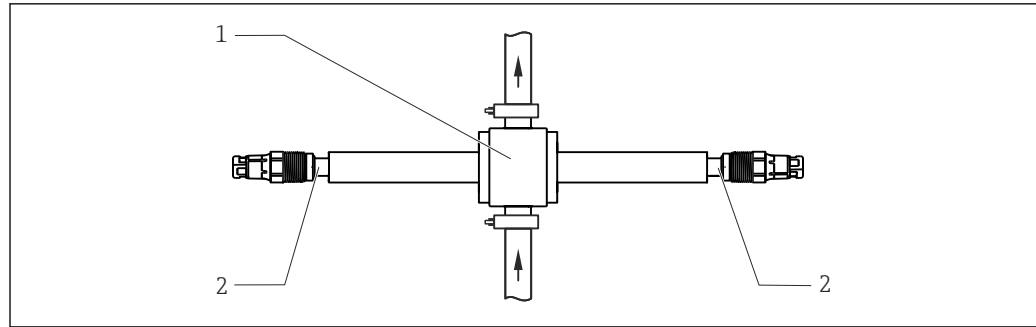

A0042963

6 Flow assembly CYA680

- 1 Flow chamber of assembly
- 2 Installed sensor Memosens COS81D

### Flow assembly CYA21 for water treatment and processes

The compact stainless steel assembly offers space for a 12 mm sensor with a length of 120 mm. The assembly has a low sampling volume and, with the 6-mm connections, it is best suited for residual oxygen measurement in water treatments and boiler feedwater. The flow comes from below.

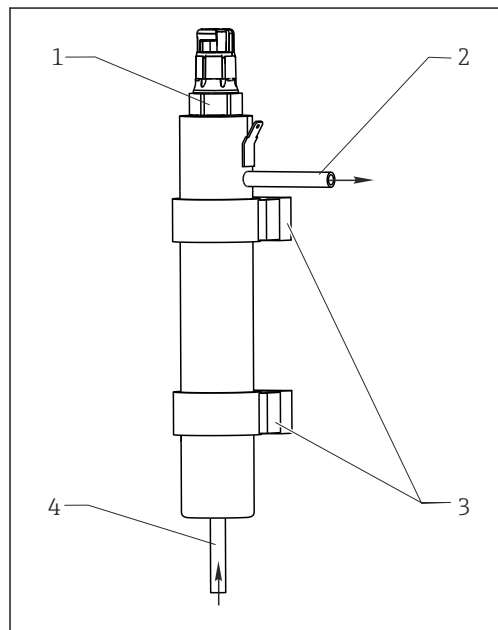

A0014081

7 Flow assembly CYA21

- 1 Installed Memosens COS81D sensor
- 2 Drain
- 3 Wall mount (clamp D29)
- 4 Inflow

### 5.3.3 Retractable assembly (CPA875 or CPA450)

The assembly is designed for installation on vessels and pipes. Suitable process connections must be available for this.

Install the assembly in a place with uniform flow conditions. The minimum pipe diameter is DN 80.

**Installation position for COS81D-\*\*\*\*U\*\*\* (with u-shaped spot cap)**

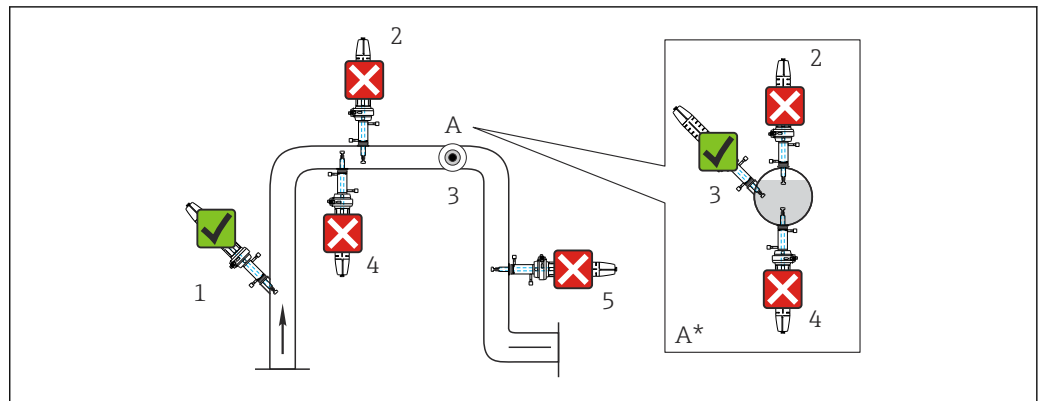

8 Permissible and impermissible installation positions for Memosens COS81D with u-shaped spot cap and retractable assembly

- 1 Ascending pipe, best position
- 2 Horizontal pipe, sensor top down, impermissible due to air cushion or foam bubble forming
- 3 Horizontal pipe, lateral installation, with suitable installation angle
- 4 Upside-down installation, unsuitable
- 5 Down pipe, impermissible
- A Detail A (top view)
- A\* Detail A, turned by 90° (side view)

- ✓ Possible installation angle
- ✗ Inadmissible installation angle

**Installation position for COS81D-\*\*\*\*C\*\*\* (with c-shaped spot cap)**

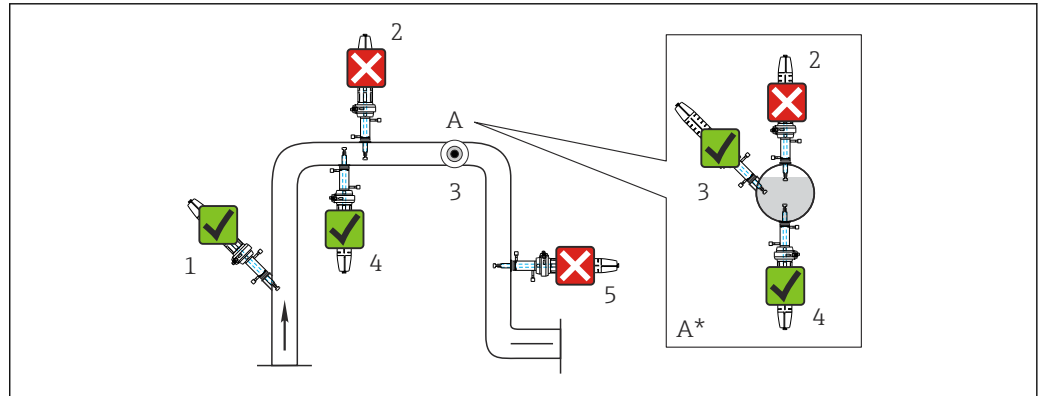

9 Suitable and unsuitable installation positions for Memosens COS81D with c-shaped spot cap and retractable assembly

- 1 Ascending pipe, best position
- 2 Horizontal pipe, sensor top down, impermissible due to air cushion or foam bubble forming
- 3 Horizontal pipe, lateral installation with permissible installation angle (acc. to sensor version)
- 4 Upside-down installation, only in conjunction with c-shaped spot cap
- 5 Down pipe, impermissible

- ✓ Possible installation angle
- ✗ Inadmissible installation angle

**NOTICE**

**Sensor not completely in the medium, deposits, upside-down installation**

These can all cause incorrect measurements!

- ▶ Do not install the assembly at points where air pockets or bubbles may form.
- ▶ Avoid or regularly remove buildup on the spot cap.
- ▶ Do not install the sensor COS81D-\*\*\*\*U (u-shaped) upside down.

## 5.4 Post-installation checks

1. Are the sensor and cable undamaged?
2. Is the orientation correct?
3. Is the sensor installed in an assembly and is not suspended from the cable?
4. Avoid the penetration of moisture.

## 6 Electrical connection

### **⚠ WARNING**

#### Device is live!

Incorrect connection may result in injury or death!

- ▶ The electrical connection may be performed only by an electrical technician.
- ▶ The electrical technician must have read and understood these Operating Instructions and must follow the instructions contained therein.
- ▶ **Prior** to commencing connection work, ensure that no voltage is present on any cable.

### 6.1 Connecting the sensor

The electrical connection of the sensor to the transmitter is established using the measuring cable CYK10.

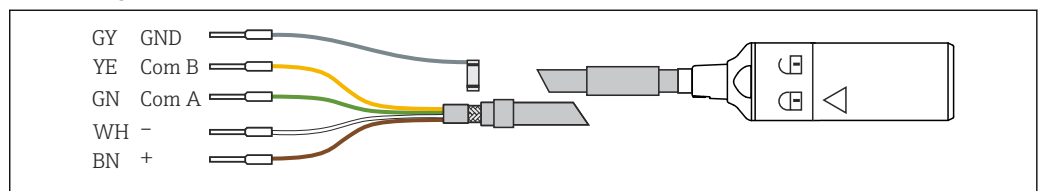

10 Measuring cable CYK10

A0024019

### 6.2 Ensuring the degree of protection

Only the mechanical and electrical connections which are described in these instructions and which are necessary for the required, designated use, may be carried out on the device delivered.

- ▶ Exercise care when carrying out the work.

Otherwise, the individual types of protection (Ingress Protection (IP), electrical safety, EMC interference immunity) agreed for this product can no longer be guaranteed due, for example to covers being left off or cable (ends) that are loose or insufficiently secured.

### 6.3 Post-connection check

Device health and specifications	Action
Is the outside of the sensor, assembly or cable free from damage?	▶ Perform a visual inspection.
Electrical connection	Action
Are the mounted cables strain-relieved and not twisted?	▶ Perform a visual inspection. ▶ Untwist the cables.
Is a sufficient length of the cable cores stripped, and are the cores positioned in the terminal correctly?	▶ Perform a visual inspection. ▶ Pull gently to check they are seated correctly.
Are the power supply and signal lines connected correctly?	▶ Use the transmitter wiring diagram.
Are all screw terminals tightened?	▶ Tighten the screw terminals.
Are all cable entries mounted, firmly tightened and leak-tight?	▶ Perform a visual inspection. In the case of lateral cable entries:
Are all cable entries mounted on the side or pointing downwards?	▶ Point cable loops downward so that water can drip off.

## 7 Calibration and adjustment

The sensor is calibrated and adjusted in the factory prior to delivery and is therefore ready for immediate use.

A recalibration or readjustment is required in the following situations:

- Changes due to process conditions, e.g. for Cleaning in Place (CIP), Sterilization in Place (SIP) and autoclaving
- Changes due to stress: temperature and/or chemicals (cleaning)
- Following a spot cap replacement

### Recommended procedure after replacing a spot cap

First calibrate and adjust the sensor at the zero point and then in the presence of oxygen.

Calibration and adjustment can also be monitored or renewed cyclically (at typical time intervals, depending on operating experience), e.g. within the context of system monitoring.

### 7.1 Types of calibration

The following types of calibration are possible:

- Zero point
  - Single-point calibration in nitrogen or zero-point gel COY8
  - Data entry
- Point at oxygen
  - Air, water vapor-saturated (recommended)
  - Air-saturated water
  - Air, variable
  - Test gas calibration
  - Data entry
  - Sample calibration
- Fermenter scaling
- Temperature adjustment

### 7.2 Zero point calibration

The zero point is not so important when working with relatively high concentrations of oxygen. In these types of application, a zero point calibration is required only after the spot cap has been replaced.

However, once oxygen sensors are used at low concentrations and in the trace range, they must also be calibrated at the zero point.

Zero point calibrations are demanding as the ambient medium - usually air - already has a high oxygen content. This oxygen must be excluded for zero point calibration of the sensor.



A calibration with the COY8 zero-point gel can be used for this purpose:

The COY8(→  35) oxygen-depleting gel creates an oxygen-free medium for zero point calibration.

Prior to sensor zero point calibration, check the following:

- Is the sensor signal stable?
- Has the adjustment time of 30 min - 40 min for the COY8 zero-point gel elapsed?
- Is the value displayed plausible?

1. If the sensor signal is stable:  
Calibrate the zero point.
2. If necessary:  
Adjust the sensor by accepting the calibration data.

-  If the oxygen sensor is calibrated too early, this can result in an incorrect zero point.  
Rule of thumb: operate the sensor for at least 30 min in the COY8 zero-point gel.
-  Follow the instructions in the kit documentation enclosed with the COY8 zero-point gel.

### 7.3 Calibration in oxygen with 100% rH

1. Remove the sensor from the medium.
  2. Clean the outside of the sensor carefully with a damp cloth.
  3. Suspend the sensor just above the surface of the water.  
Do not immerse the sensor.
  4. Allow a temperature compensation time of approx. 20 minutes for the sensor in the ambient air. Make sure that the sensor is not exposed to any direct ambient effects (direct sunlight, drafts) during this time.
  5. Is the measured value display on the transmitter stable:  
Perform the calibration in accordance with the Operating Instructions for the transmitter. Pay particular attention to the software settings for the stability criteria for calibration and for the ambient pressure.
  6. Where necessary:  
Adjust the sensor by accepting the calibration data.
  7. Then place the sensor back into the medium.
  8. Deactivate the hold status at the transmitter.
- Follow the calibration instructions in the Operating Instructions for the transmitter used.
-  The constants  $K_{sv}$  and  $\tau_0$  of the Stern-Volmer equation are determined at both calibration points (point in oxygen and zero point). The calibration quality index provides an indication of the quality of the calibration in relation to the first reference calibration of the spot cap. Therefore it is important to run the **Change sensor cap** command in the calibration menu of the transmitter before every initial calibration of a spot cap.

### 7.4 Calculation example for the calibration value

As a check, you can calculate the expected calibration value (transmitter display) as shown in the following example (salinity is 0).

1. Determine the following:
  - Ambient temperature for the sensor (air temperature for **Air 100% rh** or **Air variable** calibration types, water temperature for **H2O air-saturated** calibration type)
  - The altitude above sea level
  - The current air pressure (= relative air pressure based on sea level) at the time of calibration. (If indeterminable, use 1013 hPa.)
2. Determine the following:
  - The saturation value S acc. to Table 1
  - The altitude factor K acc. to Table 2

Table 1

T [°C (°F)]	S [mg/l=ppm]	T [°C (°F)]	S [mg/l=ppm]	T [°C (°F)]	S [mg/l=ppm]	T [°C (°F)]	S [mg/l=ppm]
0 (32)	14.64	11 (52)	10.99	21 (70)	8.90	31 (88)	7.42
1 (34)	14.23	12 (54)	10.75	22 (72)	8.73	32 (90)	7.30
2 (36)	13.83	13 (55)	10.51	23 (73)	8.57	33 (91)	7.18
3 (37)	13.45	14 (57)	10.28	24 (75)	8.41	34 (93)	7.06
4 (39)	13.09	15 (59)	10.06	25 (77)	8.25	35 (95)	6.94
5 (41)	12.75	16 (61)	9.85	26 (79)	8.11	36 (97)	6.83
6 (43)	12.42	17 (63)	9.64	27 (81)	7.96	37 (99)	6.72
7 (45)	12.11	18 (64)	9.45	28 (82)	7.82	38 (100)	6.61
8 (46)	11.81	19 (66)	9.26	29 (84)	7.69	39 (102)	6.51
9 (48)	11.53	20 (68)	9.08	30 (86)	7.55	40 (104)	6.41
10 (50)	11.25						

Table 2

Height [m (ft)]	K	Height [m (ft)]	K	Height [m (ft)]	K	Height [m (ft)]	K
0 (0)	1.000	550 (1800)	0.938	1050 (3450)	0.885	1550 (5090)	0.834
50 (160)	0.994	600 (1980)	0.932	1100 (3610)	0.879	1600 (5250)	0.830
100 (330)	0.988	650 (2130)	0.927	1150 (3770)	0.874	1650 (5410)	0.825
150 (490)	0.982	700 (2300)	0.922	1200 (3940)	0.869	1700 (5580)	0.820
200 (660)	0.977	750 (2460)	0.916	1250 (4100)	0.864	1750 (5740)	0.815
250 (820)	0.971	800 (2620)	0.911	1300 (4270)	0.859	1800 (5910)	0.810
300 (980)	0.966	850 (2790)	0.905	1350 (4430)	0.854	1850 (6070)	0.805
350 (1150)	0.960	900 (2950)	0.900	1400 (4600)	0.849	1900 (6230)	0.801
400 (1320)	0.954	950 (3120)	0.895	1450 (4760)	0.844	1950 (6400)	0.796
450 (1480)	0.949	1000 (3300)	0.890	1500 (4920)	0.839	2000 (6560)	0.792
500 (1650)	0.943						

3. Calculate factor **L**:

$$L = \frac{\text{Relative air pressure at calibration}}{1013 \text{ hPa}}$$

4. Determine the **M** factor:

- **M** = 1.02 (for **Air 100% rh** calibration type)
- **M** = 1.00 (for **H2O air-saturated** calibration type)

5. Calculate calibration value **C**:

$$C = S \cdot K \cdot L \cdot M$$



**Example**

- Air calibration at 18 °C (64 °F), altitude 500 m (1650 ft) above sea level, current air pressure 1009 hPa
- $S = 9.45 \text{ mg/l}$ ,  $K = 0.943$ ,  $L = 0.996$ ,  $M = 1.02$
- Calibration value  $C = 9.05 \text{ mg/l}$ .



Factor K in the table is not required if the measuring device returns the absolute air pressure  $L_{\text{abs}}$  (air pressure depending on altitude) as the measured value. The formula for calculation is then:  $C = S \cdot L_{\text{abs}}$ .

## 8 Commissioning

Prior to initial commissioning, ensure that:

- The sensor is correctly installed
- The electrical connection is correct

If using an assembly with automatic cleaning function:

- ▶ Check that the cleaning medium (water or air, for example) is connected correctly.

### **WARNING**

#### **Escaping process medium**

Risk of injury from high pressure, high temperatures or chemical hazards!

- ▶ Before applying pressure to an assembly with cleaning system, ensure that the system has been connected correctly.
- ▶ If you cannot reliably establish the correct connection, do not install the assembly in the process.

1. At the transmitter, enter all the settings specific to the parameters and measuring point. These include the air pressure during calibration and measurement or the salinity, for instance.
2. Check whether a calibration/adjustment is necessary.

The oxygen measuring point is then ready to measure.

- ▶ Following commissioning, service the sensor at regular intervals.

A reliable measurement is guaranteed.



 Operating Instructions for the transmitter used, such as BA01245C if using the Liquiline CM44x or CM44xR.

## 9 Troubleshooting

- ▶ If one of the following problems is present:  
Check the measuring system in the order shown.

Problem	Check	Remedy
Blank display, no sensor reaction	Power supplied to the transmitter?	▶ Establish the power supply.
	Sensor cable connected correctly?	▶ Establish correct connection.
	Deposit buildup on the spot cap?	▶ Clean the sensor cap or fluorescence layer carefully with a damp cloth.
Displayed value too high	Is sensor calibrated/adjusted? Measured value in air not $100 \pm 2$ %SAT?	▶ Recalibrate/readjust. ↳ When calibrating, enter the current air pressure at the transmitter.
	Displayed temperature clearly too low?	▶ Check sensor, if necessary send sensor in for repair.
	For TOP68 plug-in connection: moisture or dirt in the plug?	▶ Clean and dry the plug-in connection.
	Has salinity been taken into account?	▶ Enter salinity value on transmitter.
Displayed value too low	Is sensor calibrated/adjusted? Measured value in air not $100 \pm 2$ %SAT?	▶ Recalibrate/readjust. ↳ When calibrating, enter the current air pressure at the transmitter.
	Displayed temperature clearly too high?	▶ Check sensor, if necessary send sensor in for repair.
	Medium flow present?	▶ Create medium flow.
	Is the fluorescence cap worn?	▶ Replace the fluorescence cap.
	Buildup on the fluorescence layer?	▶ Clean the sensor carefully with a soft cloth.
Fluctuations in measured value	Are there air bubbles on the spot cap?	<ol style="list-style-type: none"> <li>1. Change the installation angle.</li> <li>2. If necessary, change the cap type from a u-shaped to a c-shaped cap.</li> </ol>
Display in Vol% or %SAT not plausible	Medium pressure not taken into account	▶ Enter medium pressure on transmitter.

1. Pay attention to the troubleshooting information in the Operating Instructions for the transmitter.
2. Check the transmitter if necessary.

## 10 Maintenance

Take all the necessary precautions in time to ensure the operational safety and reliability of the entire measuring system.

### NOTICE

#### Effects on process and process control!

- ▶ When carrying out any work on the system, bear in mind any potential impact this could have on the process control system and the process itself.
- ▶ For your own safety, only use genuine accessories. With genuine parts, the function, accuracy and reliability are also ensured after maintenance work.

### 10.1 Maintenance schedule

Maintenance cycles depend to a great extent on the operating conditions.

The following rule of thumb applies:

- Constant conditions, e.g. power plant = long cycles (1/2 year)
- Widely varying conditions, e.g. daily CIP or SIP cleaning, fluctuating process pressure = short cycles (1 month and shorter)

The following method helps determine the necessary intervals:

1. Inspect the sensor one month after commissioning. To do so, remove the sensor from the medium and dry it carefully.
2. Visually check the spot cap.
  - ↳ There should be no green coloration or air bubbles visible on the exterior. Otherwise, replace the spot cap.
3. After 10 minutes, measure the oxygen saturation index in air.
  - ↳ Decide using the results:
    - a) Measured value not  $100 \pm 2$  %SAT? → Service the sensor.
    - b) Measured value =  $100 \pm 2$  %SAT? → Double the length of time to the next inspection.
4. Proceed as indicated in Step 1 after two, four and eight months.
  - ↳ This allows you to determine the optimum maintenance interval for your sensor.

### NOTICE



#### Implausible sensor behavior

Damage to the luminescence layer even within a maintenance cycle.

- ▶ Check the cable connection.
- ▶ Send sensor in for repair.

### 10.2 Maintenance work

The following tasks must be performed:

1. Clean the sensor spot cap . →  29
2. Replace wear parts or consumables. →  30
3. Check measurement function. →  33
4. Recalibrate (if desired or necessary).
  - ↳ Follow the Operating Instructions for the transmitter.

### 10.3 Cleaning the exterior of the sensor

The measurement can be corrupted by sensor fouling or malfunction due to the following, for example:

Deposit buildup on the spot cap

↳ This results in a longer response time

For reliable measurement, the sensor must be cleaned at regular intervals. The frequency and intensity of the cleaning operation depend on the medium.

Clean the sensor:

- Before every calibration
- Before returning it for repairs



Type of contamination	Cleaning
Salt deposits	<ol style="list-style-type: none"> <li>1. Immerse the sensor in drinking water.</li> <li>2. Then rinse it with copious amounts of water.</li> </ol>
Dirt particles on the sensor shaft and shaft sleeve ( <b>not spot cap!</b> )	▶ Clean sensor shaft and sleeve with water and a suitable sponge.
Dirt particles on spot cap	▶ Clean the spot cap with water. No mechanical cleaning.

- ▶ After cleaning:  
Rinse with copious amounts of clean water.

### 10.4 Cleaning the sensor optics

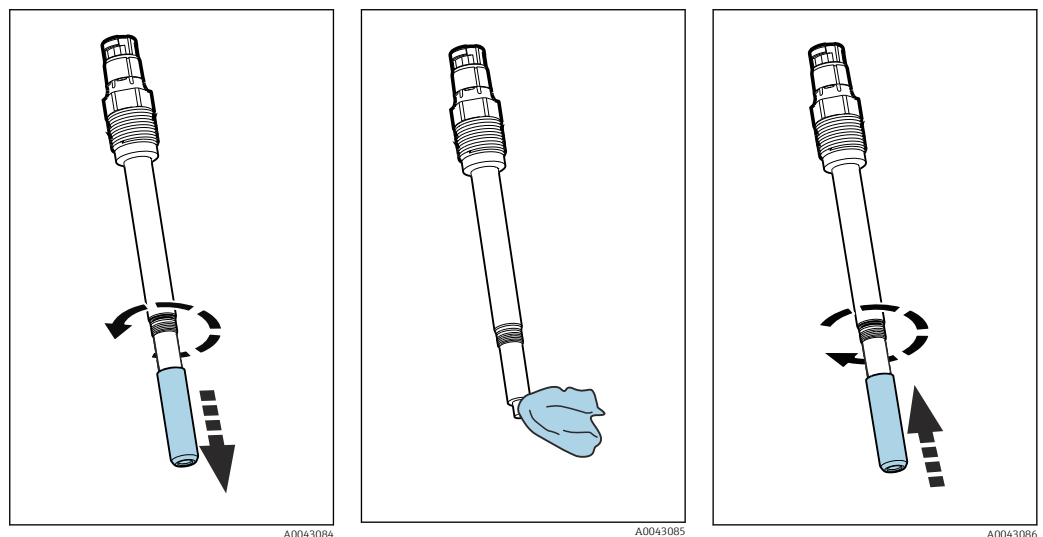
The optics need to be cleaned only if there is visible buildup on the optical waveguide or boundary area.



1. Unscrew the spot cap from the sensor head.
2. Carefully clean the optical surface (→  1,  9, item 8) with a soft cloth (preferably the cleaning cloth supplied with the COV81 maintenance kit) until the buildup is fully removed.
3. Wipe the optical surface with a soft cloth that is wetted with drinking water or distilled water.
4. Dry the optical surface and screw on a functional spot cap.
5. At the transmitter, execute the **Sensor cap change** command and then perform the necessary calibrations.

**NOTICE**

**Damage, scratches on optical surface**

Distorted measured values

- ▶ Make sure that the optical surface is not scratched or damaged in any other way.

## 10.5 Wear parts and consumables

Parts of the sensor are subject to wear during operation. By taking suitable measures, you can restore the normal operating function.

Action required	Reason
Replace process seals	Visible damage to a process seal
Replace spot cap , including O-rings.	<ul style="list-style-type: none"> <li>■ Fluorescence layer</li> <li>■ Visible damage to the O-ring</li> </ul>

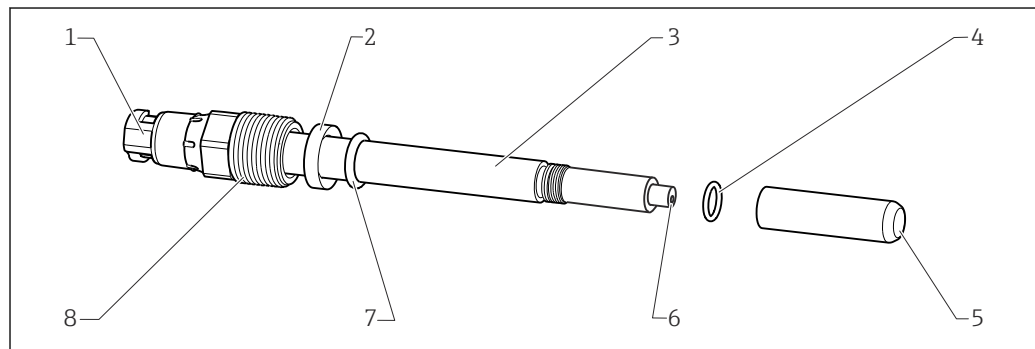

11 Memosens COS81D

- |  |   |
|--|---|
| 1 Memosens plug-in head with optics assembly | 5 Spot cap                                  |
| 2 Thrust collar                              | 6 Optical waveguide with temperature sensor |
| 3 Sensor shaft                               | 7 Process seal 10.77 x 2.62 mm              |
| 4 O-ring sensor shaft                        | 8 Process connection Pg 13.5                |

**i** The suitability of the selected materials for use in the process must be assessed during the product configuration.

Process conditions that go beyond the resistance range of the materials may shorten the operating life of the materials and make maintenance necessary.

The sensor's spot cap can have either a c-shaped or u-shaped design.

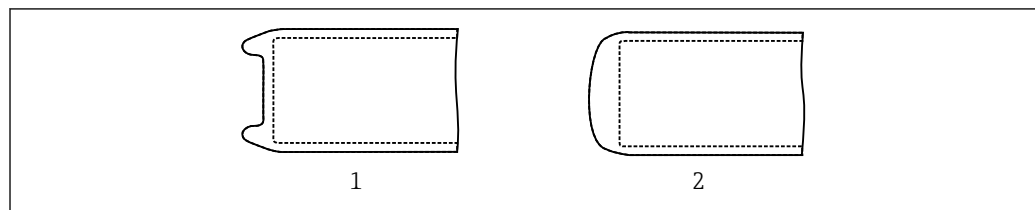



12 Design of spot cap

- 1 u-shaped
- 2 c-shaped

### 10.5.1 Replacing sealing rings

The replacement of the sealing ring is essential if visibly damaged and recommended if replacing the spot cap. Use only original sealing rings.

The following O-rings can be replaced:

- Sealing ring for shaft sleeve: item 4 →  30 →  1,  9
- Sealing ring to process (conductive for Ex): item 7

**Replacing the sealing ring for the shaft sleeve**

1.

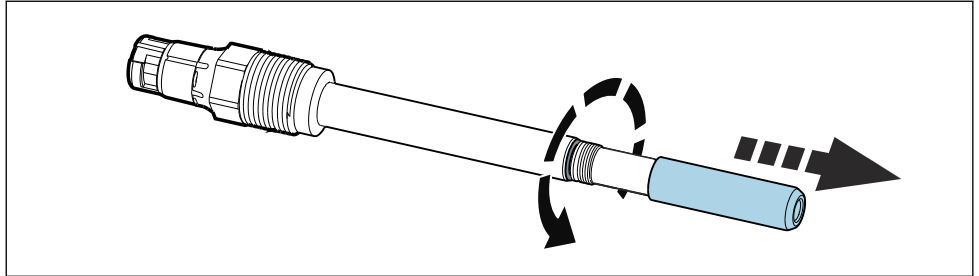

A0043010

Unscrew the spot cap.

2.

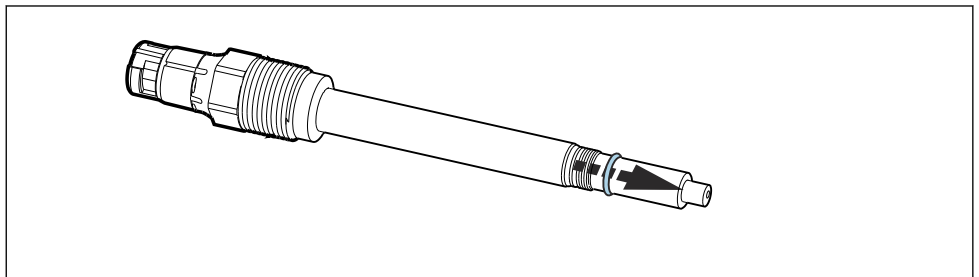

A0034713

Remove the old O-ring above the thread on the shaft.

3.

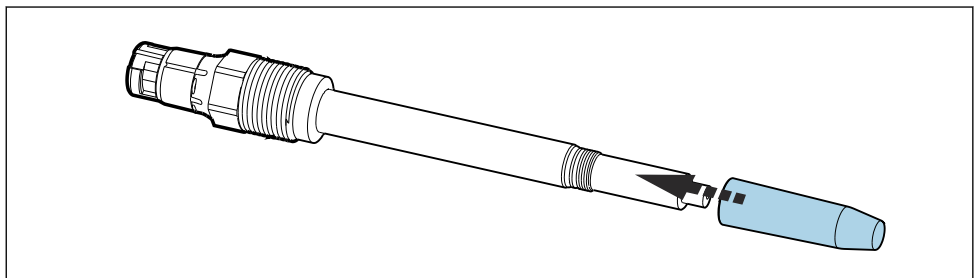

A0034715

Push the mounting tool from below onto the shaft until it sits over the thread.

4.

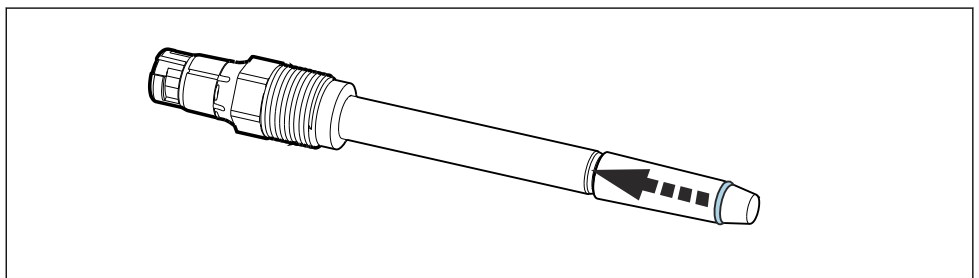

A0034717

Slide the new O-ring over the mounting tool into the position above the thread.

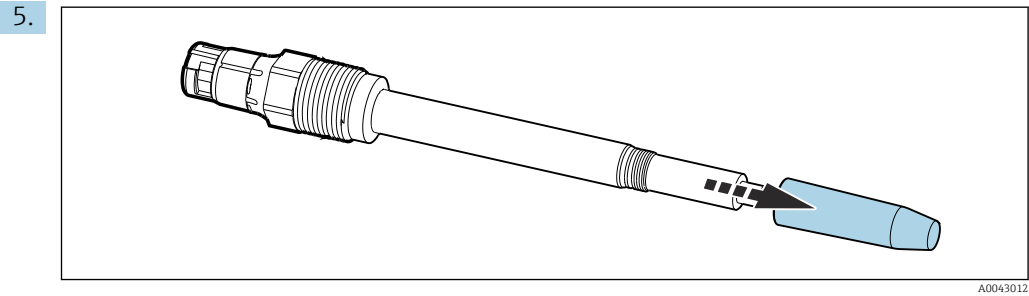

Remove the mounting tool.

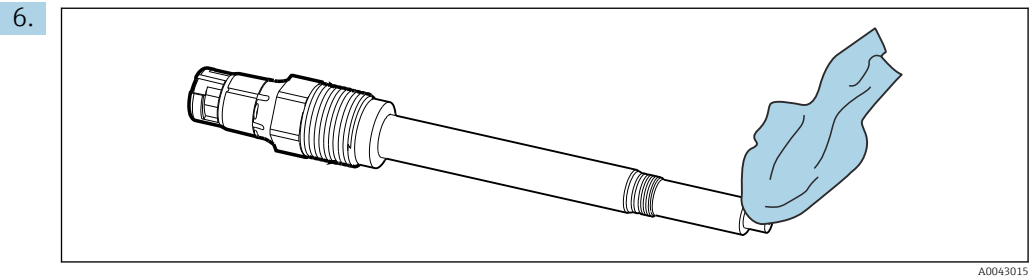

Clean the sensor optics carefully using the cloth provided.

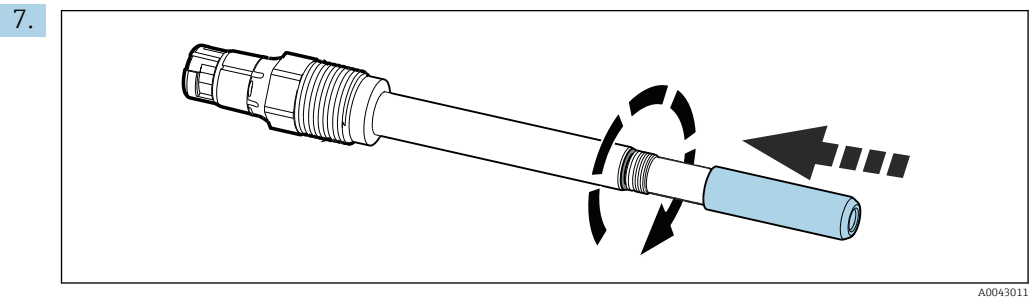

Screw on the spot cap.

**Replacing the sealing ring towards the process**

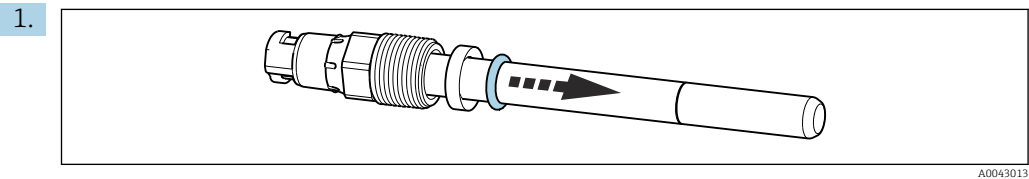

Remove the old O-ring on the process connection in the direction of the spot cap.

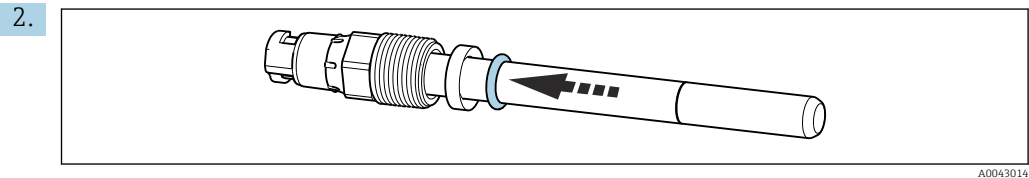

Fit the new O-ring over the spot cap and push it as far as the process connection.

**10.5.2 Replacing the spot cap**

The spot cap must be replaced if it is visibly damaged or the sensor measurement quality is not sufficient. Only use original spot caps.



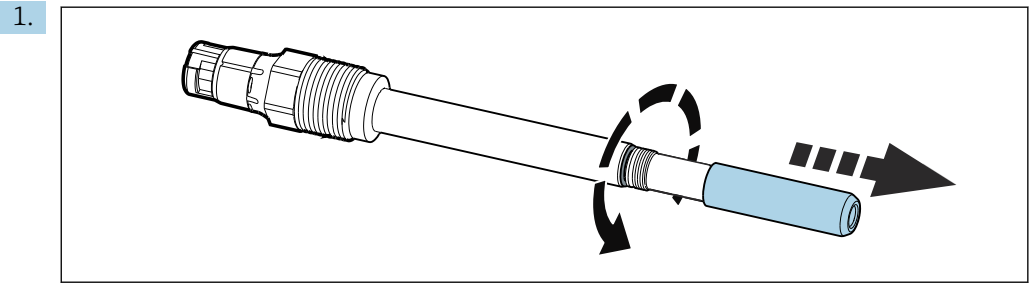

Unscrew the old spot cap and remove.

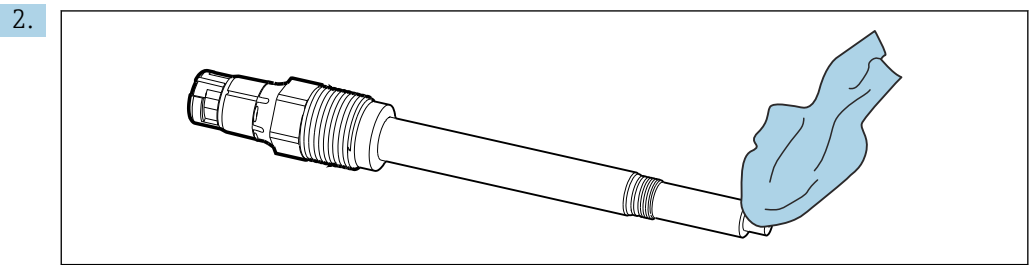

Clean the sensor optics carefully using the cloth provided.

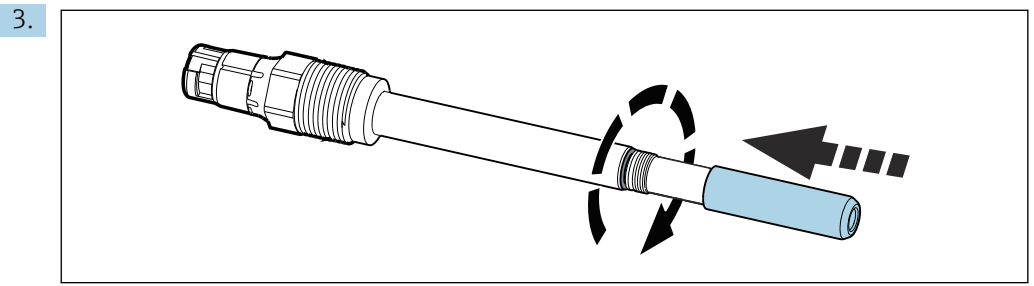

Screw on the new spot cap.

4. Calibrate the sensor and check the measurement function. → 22

## 10.6 Checking the measurement function

1. Remove the sensor from the medium.
2. Clean and dry the spot cap.
3. Adjust the process pressure at the transmitter if it differs from the atmospheric pressure; otherwise, a comparison will not be possible.
4. After about 10 minutes, measure the oxygen saturation index in air (without recalibration).
  - ↳ The measured value should be at  $100 \pm 2$  %SAT.

## 11 Accessories

The following are the most important accessories available at the time this documentation was issued.

Listed accessories are technically compatible with the product in the instructions.

1. Application-specific restrictions of the product combination are possible. Ensure conformity of the measuring point to the application. This is the responsibility of the operator of the measuring point.
2. Pay attention to the information in the instructions for all products, particularly the technical data.
3. For accessories not listed here, please contact your Service or Sales Center.

### 11.1 Assemblies (selection)

 COS81D with 220 mm length is suitable for all assemblies requiring an installation length of 225 mm.

#### Cleanfit CPA875

- Retractable process assembly for sterile and hygienic applications
- For in-line measurement with standard sensors with 12 mm diameter, e.g. for pH, ORP, oxygen
- Product Configurator on the product page: [www.endress.com/cpa875](http://www.endress.com/cpa875)

 Technical Information TI01168C

#### Unifit CPA842

- Installation assembly for food, biotechnology and pharmaceuticals
- With EHEDG and 3A certificate
- Product Configurator on the product page: [www.endress.com/cpa842](http://www.endress.com/cpa842)

 Technical Information TI00306C

#### Cleanfit CPA450

- Manual retractable assembly for installing sensors with a diameter of 12 mm and a length of 120 mm in tanks and pipes
- Product Configurator on the product page: [www.endress.com/cpa450](http://www.endress.com/cpa450)

 Technical Information TI00183C

#### Flow assembly

- For sensors with Ø 12 mm and length 120 mm
- Compact stainless steel assembly with low sampling volume
- Order No.: 71042404

#### Flowfit CYA21

- Universal assembly for analysis systems in industrial utilities
- Product Configurator on the product page: [www.endress.com/CYA21](http://www.endress.com/CYA21)

 Technical Information TI01441C

#### CYA680

- Flow assembly for hygienic sensors
- For sensor installation in pipes
- Suitable for cleaning in place (CIP) and sterilization in place (SIP)
- Certified biocompatibility as per USP Class VI, FDA-listed seals and hygienic, electropolished surfaces Ra=0.38 µm (15 µinch)
- Product Configurator on the product page: [www.endress.com/cya680](http://www.endress.com/cya680)

 Technical Information TI01295C

## 11.2 Measuring cable

### Memosens data cable CYK10

- For digital sensors with Memosens technology
- Product Configurator on the product page: [www.endress.com/cyk10](http://www.endress.com/cyk10)



Technical Information TI00118C

### Memosens data cable CYK11

- Extension cable for digital sensors with Memosens protocol
- Product Configurator on the product page: [www.endress.com/cyk11](http://www.endress.com/cyk11)



Technical Information TI00118C

### Memosens laboratory cable CYK20

- For digital sensors with Memosens technology
- Product Configurator on the product page: [www.endress.com/cyk20](http://www.endress.com/cyk20)

## 11.3 Zero-point gel

### COY8

Zero-point gel for oxygen and disinfection sensors

- Disinfectant-free gel for the verification, zero point calibration and adjustment of oxygen and disinfection measuring points
- Product Configurator on the product page: [www.endress.com/coy8](http://www.endress.com/coy8)



Technical Information TI01244C

## 12 Repair

### 12.1 Spare parts and consumables

#### Memosens COV81

- Maintenance kit for COS81D
- Ordering information: [www.endress.com/cos81d](http://www.endress.com/cos81d) under "Accessories/spare parts"

### 12.2 Return

The product must be returned if repairs or a factory calibration are required, or if the wrong product was ordered or delivered. As an ISO-certified company and also due to legal regulations, Endress+Hauser is obliged to follow certain procedures when handling any returned products that have been in contact with medium.

To ensure the swift, safe and professional return of the device:

- ▶ Refer to the website [www.endress.com/support/return-material](http://www.endress.com/support/return-material) for information on the procedure and conditions for returning devices.

### 12.3 Disposal



If required by the Directive 2012/19/EU on waste electrical and electronic equipment (WEEE), the product is marked with the depicted symbol in order to minimize the disposal of WEEE as unsorted municipal waste. Do not dispose of products bearing this marking as unsorted municipal waste. Instead, return them to the manufacturer for disposal under the applicable conditions.

## 13 Technical data

### 13.1 Input

Measured variables	Dissolved oxygen [mg/l, µg/l, ppm, ppb, %SAT] Oxygen (gaseous) [hPa or %Vol] Temperature [°C, °F]
--------------------	---

Measuring ranges Measuring ranges apply for 25 °C (77 °F) and 1013 hPa (15 psi)

c-shaped	u-shaped
0.004 to 26 mg/l 0.05 to 285 %SAT 0.1 to 600 hPa	0.004 to 30 mg/l 0.05 to 330 %SAT 0.1 to 700 hPa

### 13.2 Performance characteristics

Response time	From air to nitrogen at reference operating conditions: <ul style="list-style-type: none"> <li>■ <math>t_{90}</math> : &lt; 10 s</li> <li>■ <math>t_{98}</math> : &lt; 20 s</li> </ul>
---------------	--

Reference conditions	Reference temperature: 25 °C (77 °F)
	Reference pressure: 1013 hPa (15 psi)

Maximum measured error<sup>1)</sup> At 25 °C (77 °F)

Measured value [mg/l]	Maximum measured error [mg/l]	Measured value [hPa]	Maximum measured error [hPa]
0.04	±0.008	1	±0.2
0.8	±0.017	20	±0.4
9.1	±0.1	210	±2
26	±0.5	600	±12

### 13.3 Environment

Ambient temperature range	-5 to +100 °C (23 to 212 °F)
---------------------------	------------------------------

Storage temperature range	-25 to 50 °C (-13 to 122 °F) at 95% relative humidity, non-condensing
---------------------------	--

Degree of protection	IP68 (10 m (33 ft) water column at 25 °C (77 °F) over 28 days)
----------------------	--

1) In accordance with IEC 60746-1 under rated operating conditions

IP69K (test in accordance with DIN 40050-9)

### 13.4 Process

Process temperature	Sensor	General	Oxygen measurement
	COS81D-****1* (EPDM)	-10 to +140 °C (15 to 280 °F)	
	COS81D-****3* (FFKM)	0 to +140 °C (32 to 280 °F)	
	COS81D-**C*** (c-shaped)		0 to 60 °C (32 to 140 °F)
	COS81D-**U*** (u-shaped)		0 to 80 °C (32 to 175 °F)

Process pressure 0.02 to 13 bar (0 to 190 psi) abs.

Temperature/pressure ratings

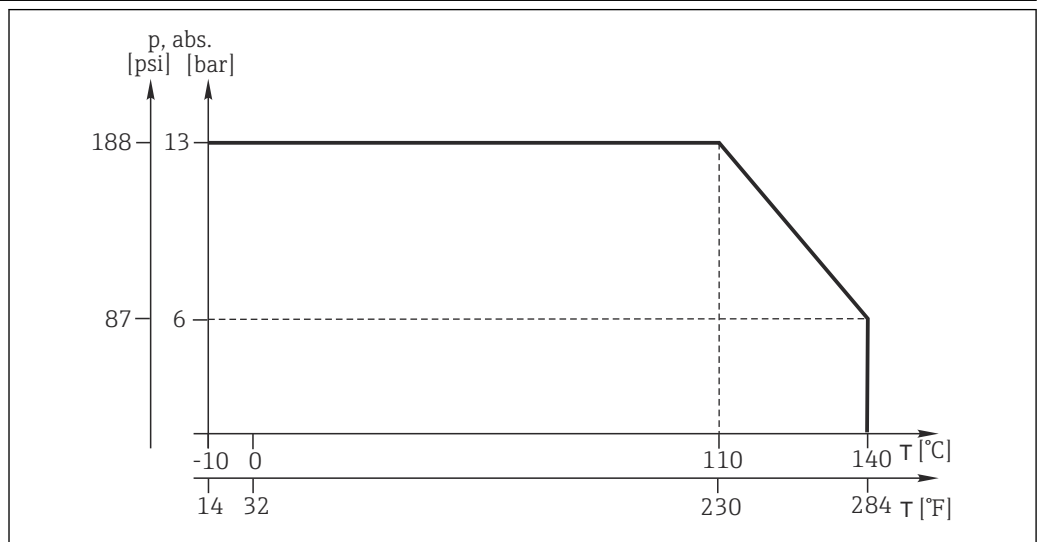

A0045731

Chemical resistance

**NOTICE**

**Halogen-containing solvents, ketones and toluene**

Halogen-containing solvents (dichloromethane, chloroform), ketones (e.g. acetone, pentanone) and toluene have a cross-sensitive effect and result in decreased measured values or, at worst, in the complete failure of the sensor!

- Use the sensor only in media that are free from halogens, ketones and toluene.

CIP compatibility Yes

SIP compatibility Yes, max. 140 °C (284 °F)

Autoclavability Yes, max. 140 °C (284 °F)

### 13.5 Mechanical construction

Device type The sensor's spot cap can have either a c-shaped or u-shaped design.

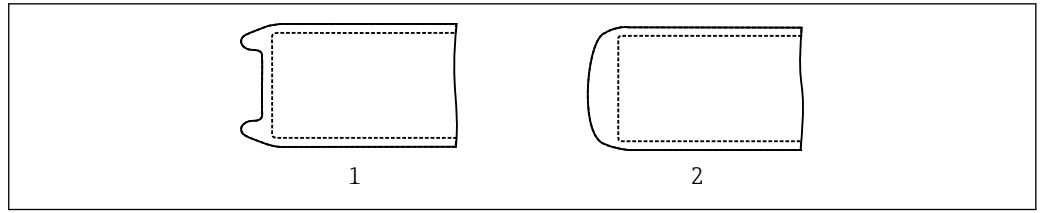

13 Design of spot cap

- 1 u-shaped
- 2 c-shaped

A0034733

Dimensions

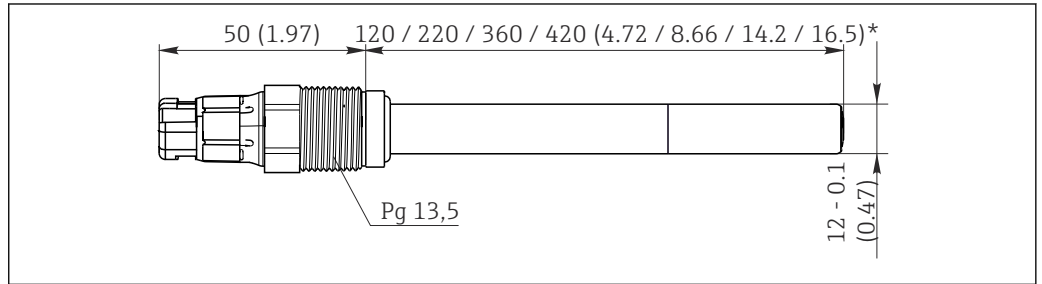

14 Dimensions in mm (inch)

A0034910

Flow assembly CYA21 for sensors with Ø 12 mm (accessory)

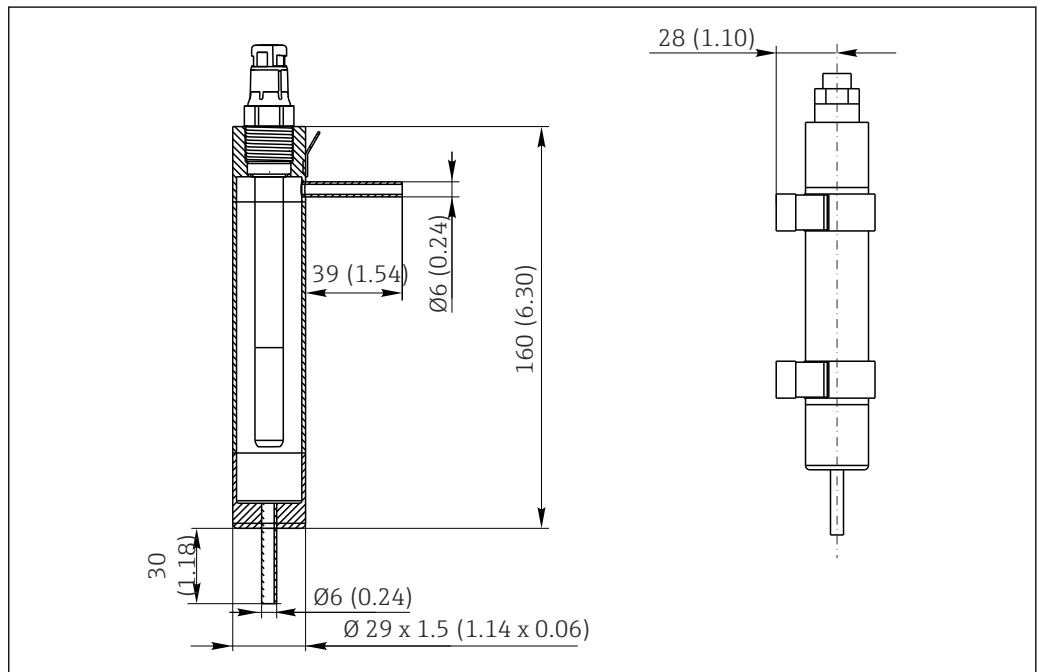

15 Dimensions in mm (inch)

A0043025

Weight

Depending on the design (length)  
 Example: 0.1 kg (0.20 lbs) for version with 120 mm length

Materials

**Parts in contact with medium**

Sensor shaft	Stainless steel 1.4435 (AISI 316L)
Process seal	FKM (USP<87>, <88> Class VI and FDA)
Process seal for Ex versions	FKM (not FDA-compliant)

---

Seals/O-rings	EPDM, FFKM (USP<87>, <88> Class VI and FDA)
Spot layer	Silicone (USP<87>, <88> Class VI and FDA)

---

Process connection	Pg 13.5 Torque max. 3 Nm
--------------------	-----------------------------

---

Surface roughness	$R_a < 0.38 \mu\text{m}$
-------------------	--------------------------

---

Temperature sensor	Pt1000 (Class A according to DIN IEC 60751)
--------------------	---

---



# 14 Appendices

<p><b>EU-Konformitätserklärung</b>  <b>EU-Declaration of Conformity</b>  <b>Déclaration UE de Conformité</b></p>		<p><b>Endress+Hauser</b>                   People for Process Automation</p>															
																	
<b>Company</b>	<p><b>Endress+Hauser Conducta GmbH+Co. KG</b>                  Dieselstraße 24, 70839 Gerlingen, Germany                  erklärt als Hersteller in alleiniger Verantwortung, dass das Produkt                  declares as manufacturer under sole responsibility, that the product                  déclare sous sa seule responsabilité en qualité de fabricant que le produit</p>																
<b>Product</b>	<p><b>Oxymax H</b>                  COS81D-BA*****3</p>																
<b>Regulations</b>	<p>den folgenden Europäischen Richtlinien entspricht:                  conforms to following European Directives:                  est conforme aux prescription des Directives Européennes suivantes :</p> <p>EMC 2014/30/EU (L96/79)                  ATEX 2014/34/EU (L96/309)                  RoHS 2011/65/EU (L174/88)</p>																
<b>Standards</b>	<p>angewandte harmonisierte Normen oder normative Dokumente:                  applied harmonized standards or normative documents:                  normes harmonisées ou documents normatifs appliqués :</p> <table border="0"> <tr> <td>EN 61326-1</td> <td>(2013)</td> <td>EN 60079-0</td> <td>(2012)</td> <td>A11:2013</td> </tr> <tr> <td>EN 61326-2-3</td> <td>(2013)</td> <td>EN 60079-11</td> <td>(2012)</td> <td></td> </tr> <tr> <td>EN 50581</td> <td>(2012)</td> <td></td> <td></td> <td></td> </tr> </table>		EN 61326-1	(2013)	EN 60079-0	(2012)	A11:2013	EN 61326-2-3	(2013)	EN 60079-11	(2012)		EN 50581	(2012)			
EN 61326-1	(2013)	EN 60079-0	(2012)	A11:2013													
EN 61326-2-3	(2013)	EN 60079-11	(2012)														
EN 50581	(2012)																
<b>Certification</b>	<table border="0"> <tr> <td>EG-Baumusterprüfbescheinigung Nr.</td> <td>BVS 12 ATEX E 121 X</td> </tr> <tr> <td>EC-Type Examination Certificate No.</td> <td></td> </tr> <tr> <td>Numéro de l'attestation d'examen CE de type</td> <td></td> </tr> <tr> <td>Ausgestellt von/Issued by/délivré par</td> <td>DEKRA EXAM GmbH (0158)</td> </tr> <tr> <td>Qualitätssicherung/Quality assurance/Système d'assurance qualité</td> <td>DEKRA EXAM GmbH (0158)</td> </tr> </table>		EG-Baumusterprüfbescheinigung Nr.	BVS 12 ATEX E 121 X	EC-Type Examination Certificate No.		Numéro de l'attestation d'examen CE de type		Ausgestellt von/Issued by/délivré par	DEKRA EXAM GmbH (0158)	Qualitätssicherung/Quality assurance/Système d'assurance qualité	DEKRA EXAM GmbH (0158)					
EG-Baumusterprüfbescheinigung Nr.	BVS 12 ATEX E 121 X																
EC-Type Examination Certificate No.																	
Numéro de l'attestation d'examen CE de type																	
Ausgestellt von/Issued by/délivré par	DEKRA EXAM GmbH (0158)																
Qualitätssicherung/Quality assurance/Système d'assurance qualité	DEKRA EXAM GmbH (0158)																
<p>Gerlingen, 03.08.2017                  Endress+Hauser Conducta GmbH+Co. KG</p>																	
	 i. V. Jörg-Martin Müller Technology	 i. V. Sven-Matthias Scheibe Technology Certifications and Approvals															
<p>EC_00577_01.17</p>																	

# Index

## A

Accessories . . . . .	34
Adjustment . . . . .	22
Ambient temperature range . . . . .	37
Approvals	
Marine . . . . .	14
ASME BPE . . . . .	13
Assemblies . . . . .	34
Autoclavability . . . . .	38

## B

Biological reactivity test . . . . .	14
--------------------------------------	----

## C

Calibration	
Calculation example . . . . .	23
In air . . . . .	23
Types of calibration . . . . .	22
Zero point calibration . . . . .	22
CE mark . . . . .	12
Certification body . . . . .	13
Check	
Connection . . . . .	21
Installation . . . . .	20
Chemical resistance . . . . .	38
CIP compatibility . . . . .	38
Cleaning	
Sensor . . . . .	29
Sensor optics . . . . .	29
Cleaning the sensor optics . . . . .	29
Connection	
Check . . . . .	21
Ensuring the degree of protection . . . . .	21

## D

Declaration of conformity . . . . .	12
Degree of protection	
Degree of protection . . . . .	37
Ensuring . . . . .	21
Design . . . . .	38
Designated use . . . . .	5
Device description . . . . .	8
Device type . . . . .	38
Dimensions . . . . .	39
Disposal . . . . .	36

## E

EHEDG . . . . .	13
Electrical connection . . . . .	21
Environment . . . . .	37
Ex approvals . . . . .	12
Explosive atmospheres . . . . .	6

## F

FDA compatibility . . . . .	13
Function . . . . .	8

## I

Identifying the product . . . . .	11
Incoming acceptance . . . . .	11
Installation	
Check . . . . .	20
Examples . . . . .	17
Orientation . . . . .	15
Sensor . . . . .	16
Installation instructions . . . . .	15

## M

Maintenance schedule . . . . .	28
Maintenance work . . . . .	28
Manufacturer's address . . . . .	12
Marine . . . . .	14
Material test certificate . . . . .	13
Materials . . . . .	39
Measured error . . . . .	37
Measured variables . . . . .	37
Measurement function . . . . .	33
Measuring cable . . . . .	35
Measuring point . . . . .	17
Measuring principle . . . . .	8
Measuring ranges . . . . .	37
Measuring system . . . . .	16

## N

Nameplate . . . . .	11
---------------------	----

## O

Operational safety . . . . .	6
Optical measuring principle . . . . .	8
Orientation . . . . .	15

## P

Performance characteristics . . . . .	37
Pressure/temperature ratings . . . . .	38
Process . . . . .	38
Process connection . . . . .	40
Process pressure . . . . .	38
Process temperature . . . . .	38
Product safety . . . . .	6

## R

Reference conditions . . . . .	37
Regulation 1935/2004 . . . . .	13
Repair . . . . .	36
Replacing sealing rings . . . . .	30
Response time . . . . .	37
Return . . . . .	36

## S

Safety	
Electrical equipment in explosive atmospheres . . . . .	6
Operation . . . . .	6
Product . . . . .	6
Workplace safety . . . . .	5

Safety instructions . . . . .	5
Scope of delivery . . . . .	12
Sensor	
Cleaning . . . . .	29
Connecting . . . . .	21
Design . . . . .	9
Installing . . . . .	16
Sensor design . . . . .	9
SIP compatibility . . . . .	38
Spare parts . . . . .	36
Spot cap . . . . .	10, 29
Stabilization time . . . . .	10
State of the art . . . . .	6
Storage temperature range . . . . .	37
Surface roughness . . . . .	40
Symbols . . . . .	4

## T

Technical data	
Environment . . . . .	37
Input . . . . .	37
Mechanical construction . . . . .	38
Performance characteristics . . . . .	37
Process . . . . .	38
Temperature sensor . . . . .	40
Temperature/pressure ratings . . . . .	38
Troubleshooting . . . . .	27

## U

Use . . . . .	5
---------------	---

## W

Warnings . . . . .	4
Wear parts and consumables . . . . .	30
Weight . . . . .	39
Workplace safety . . . . .	5

## Z

Zero solution	
Application . . . . .	22
Zero-point gel . . . . .	35



[www.addresses.endress.com](http://www.addresses.endress.com)

---