

Universal Power Rail

UPR-03

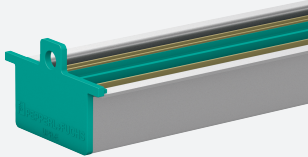

- 35 mm DIN mounting rail with 3-conductor insert
- Provides DC supply voltage to all equipped K-System modules
- Standard length 2 m (6 foot), simple to customize to application space
- Eliminates daisy-chains

Universal Power Rail with end caps and cover, 3 conductors, length: 2 m

Function

The Power Rail consists of a DIN mounting rail UPR-MR and a insert UPR-INS-03. The component has two conductors for power and one conductor for collective error messaging. The component reduces wiring and maintenance costs because it eliminates the need to daisy-chain the wires. It also simplifies expansion – just snap in a new isolator when you're ready to expand a system. The component comes in 2 m segments but can be cut to any size. The Power Rail is delivered with two UPR-E end caps and UPR-COVER cover. All components of the Power Rail can be ordered separately. In conjunction with K-System modules the component can be mounted in Zone 2.

Assembly

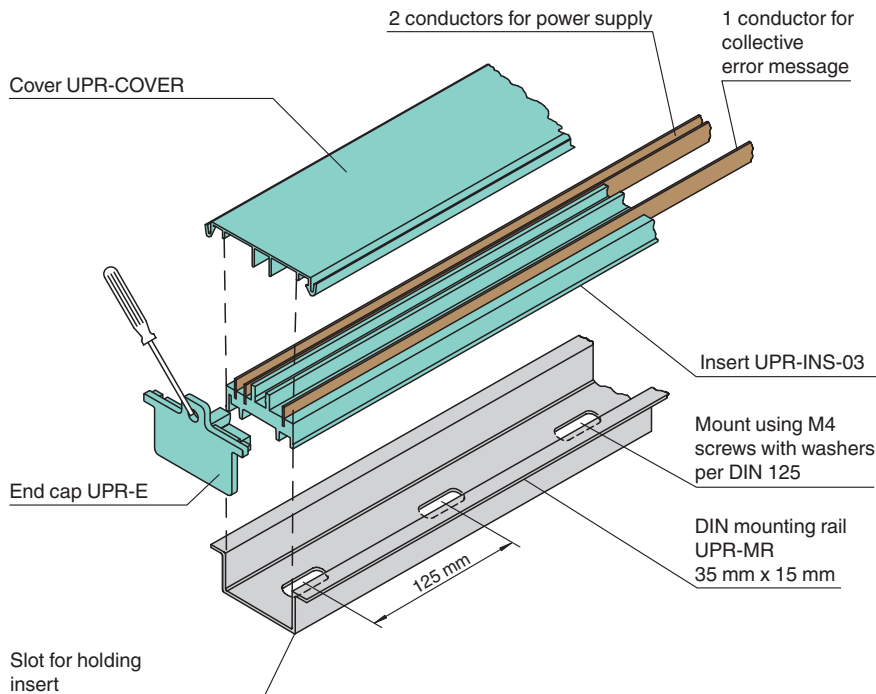

Technical Data

Electrical specifications

Rated voltage	U_r	24 V DC
Rated current	I_r	4 A

Release date: 2021-04-08 Date of issue: 2021-04-08 Filename: 119265_eng.pdf

Refer to "General Notes Relating to Pepperl+Fuchs Product Information".

Pepperl+Fuchs Group
www.pepperl-fuchs.com

USA: +1 330 486 0002
pa-info@us.pepperl-fuchs.com

Germany: +49 621 776 2222
pa-info@de.pepperl-fuchs.com















Singapore: +65 6779 9091
pa-info@sg.pepperl-fuchs.com

PF PEPPERL+FUCHS

Technical Data

Ambient conditions	
Ambient temperature	-20 ... 70 °C (-4 ... 158 °F)
Mechanical specifications	
Connection	3 conductors
Supply	2 Conductors
Fault output	1 Conductors
Dimensions	35 x 15 x 2000 mm (1.4 x 0.6 x 78.7 inch)
General information	
Scope of delivery	- DIN mounting rail UPR-MR - insert UPR-INS-03 - cover UPR-COVER - end cap UPR-E
Accessories	
Optional accessories	- end cap UPR-E - insulation spacer UPR-I - DIN mounting rail UPR-MR - insert UPR-INS-03 - cover UPR-COVER















Matching System Components

	KFD2-PT2-Ex1-1
	KFD2-SL2-Ex1 Testdaten Ventil-App
	KFD2-ER-1.5
	KFD2-HLC-Ex1.D.2W-AB
	KCD2-SR-1
	KCD2-SR-Ex1.LB.SP
	KCD2-SR-Ex2
	KCD2-SR-Ex2.SP
	KFD2-SR2-Ex1.W
	KFD2-STV5-Ex1-1
	KFD2-STC5-Ex1.H
	KFD2-CD-1.32
	KFD2-CD-1.32
	KCD2-RR2-Ex1.SP

Release date: 2021-04-08 Date of issue: 2021-04-08 Filename: 119265_eng.pdf

Refer to "General Notes Relating to Pepperl+Fuchs Product Information".





















Matching System Components

	KCD2-SCD-Ex1.ES	
	KFD2-VR4-Ex1.26	
	KFD2-CD-Ex1.32-**	
	KCD2-RR2-Ex1	
	KFD2-PT2-Ex1-Y98312	
	KFD2-SOT2-Ex1.LB	
	KFD2-RSH-1.2D.FL2	
	KFD2-RSH-1.2D.FL3	
	KFD2-RSH-1.2E.L2	
	KFD2-RSH-1.2E.L3	
	KCD2-SLD-Ex1.1045	
	KFD2-STC5-Ex1	
	KFD2-SH-Ex1.T.OP	
	KFD2-SH-Ex1	
	KFD2-PT2-Ex1	
	KFD2-PT2-Ex1-4	
	KFD2-PT2-Ex1-5	
	KFD2-VR-Ex1.18	Transmission range 0 V ... 12 V
	KFD2-VR-Ex1.19	Transmission range 0 V ... ± 10 V
	KFD2-ER-1.6	

Release date: 2021-04-08 Date of issue: 2021-04-08 Filename: 119265_eng.pdf

Refer to "General Notes Relating to Pepperl+Fuchs Product Information".

Matching System Components

	KFD2-VM-Ex1.35.L	Output 22.3 V
	KFD2-PT2-Ex1-6-Y11284-4	
	KFD2-VR-Ex1.19-Y109129	
	KFD2-VR-Ex1.12	Transmission range 0 V ... 9 V
	KFD2-VR2-Ex1.50M	Transmission range 0 mV ... ± 50 mV
	KFD2-SL2-Ex1	
	KFD2-EB2	Power Feed Module
	KFD2-EB2.R4A.B	Power feed module, redundant supply
	KFD2-SRA-Ex4	
	KFD2-USC-1.D	
	KFD2-STC5-Ex2	
	KFD2-STC5-2	Input 0/4 mA ... 20 mA Output 0/4 mA ... 20 mA (current sink)
	KFD2-SR2-Ex1.W.LB	
	KFD2-SR2-Ex2.W	
	KCD2-STC-1	Input 4 mA ... 20 mA Output 4 mA ... 20 mA
	KFD2-VR2-Ex1.500M	Transmission range 0 mV ... ± 500 mV
	KFD2-ER-Ex1.W.LB	24 V DC
	KFD2-ER-2.W.LB	24 V DC
	KFD2-ER-1.W.LB	24 V DC
	KFD2-SH-Ex1.T	

Release date: 2021-04-08 Date of issue: 2021-04-08 Filename: 119265_eng.pdf

Refer to "General Notes Relating to Pepperl+Fuchs Product Information".

Pepperl+Fuchs Group
www.pepperl-fuchs.com





















USA: +1 330 486 0002
pa-info@us.pepperl-fuchs.com

Germany: +49 621 776 2222
pa-info@de.pepperl-fuchs.com

Singapore: +65 6779 9091
pa-info@sg.pepperl-fuchs.com

 **PEPPERL+FUCHS**









Matching System Components

	KCD2-SR-Ex1.LB	
	KCD2-SR-1.LB	
	KCD2-SR-2	
	KCD2-SR-Ex2	
	KCD2-UT2-Ex1	Current output 0/4 mA ... 20 mA
	KFD2-UFC-1.D	24 V DC
	KFD2-UFC-Ex1.D	24 V DC
	KFD2-UFT-2.D	24 V DC
	KFD2-UFT-Ex2.D	24 V DC
	KFD2-DWB-Ex1.D	24 V DC
	KFD2-DWB-1.D	24 V DC
	KFD2-DU-Ex1.D	
	KFD2-GUT-1.D	
	KFD2-GUT-Ex1.D	
	KCD2-SR-1.LB.SP	
	KCD2-SR-2.SP	
	KCD2-SR-Ex1.LB.SP	
	KCD2-SR-Ex2.SP	
	KCD2-STC-1.SP	Input 4 mA ... 20 mA Output 4 mA ... 20 mA
	KFD2-EB2.SP	Power feed module with spring terminals

Release date: 2021-04-08 Date of issue: 2021-04-08 Filename: 119265_eng.pdf

Refer to "General Notes Relating to Pepperl+Fuchs Product Information".

Matching System Components

	KFD2-EB2.R4A.B.SP	Power feed module with spring terminals, redundant supply
	KFD2-STV5-2-1	
	KFD2-STV5-Ex2-1	
	KFD2-STC5-1	
	KFD2-STV5-1-1	
	KFD2-STC5-Ex1.20	
	KFD2-STC5-1.20	
	KFD2-STV5-Ex1.20-1	
	KFD2-STC5-Ex1.20.H	
	KFD2-SLD-Ex1.13100	
	KFD2-UT2-1	
	KFD2-UT2-1-1	Voltage output 0/1 V ... 5 V
	KFD2-UT2-2	
	KFD2-UT2-2-1	Voltage output 0/1 V ... 5 V
	KFD2-UT2-Ex1	Current output 0/4 mA ... 20 mA
	KFD2-UT2-Ex1-1	Voltage output 0/1 V ... 5 V
	KFD2-UT2-Ex2	Current output 0/4 mA ... 20 mA
	KFD2-UT2-Ex2-1	Voltage output 0/1 V ... 5 V
	KCD2-UT2-1	Current output 0/4 mA ... 20 mA
	KFD2-CRG2-Ex1.D	

Release date: 2021-04-08 Date of issue: 2021-04-08 Filename: 119265_eng.pdf

Refer to "General Notes Relating to Pepperl+Fuchs Product Information".





















Pepperl+Fuchs Group
www.pepperl-fuchs.com

USA: +1 330 486 0002
pa-info@us.pepperl-fuchs.com

Germany: +49 621 776 2222
pa-info@de.pepperl-fuchs.com





















Singapore: +65 6779 9091
pa-info@sg.pepperl-fuchs.com

Matching System Components

	KFD2-CRG2-1.D	
	KFD2-HLC-Ex1.D	
	KFD2-HLC-Ex1.D.2W	
	KFD2-HLC-Ex1.D.4S	
	KFD2-SOT3-Ex1.LB	
	KFD2-SOT3-Ex2	
	KFD2-ST3-Ex1.LB	24 V DC
	KFD2-ST3-Ex2	
	KFD2-CRG2-Ex1.D-AB	
	KFD2-SOT3-Ex1.LB.IO	
	KFD2-SOT3-Ex2.IO	
	KFD2-SOT3-Ex2.IO-Y1	24 V DC
	KCD2-STC-Ex1.2O	
	KCD2-STC-Ex1.2O.DE	Input 0/4 mA ... 20 mA, 2 x output 0/4 mA ... 20 mA
	KCD2-STC-Ex1.2O.ES	
	KFD2-CD-Ex1.32	
	KFD2-GS-1.2W	
	KFD2-STV5-Ex2-2	
	KFD2-STV5-Ex1-2	
	KFD2-STV5-Ex1.2O-2	
	KFD2-CD-Ex1.32-13	

Release date: 2021-04-08 Date of issue: 2021-04-08 Filename: 119265_eng.pdf











Matching System Components

	KFD2-CD-Ex1.32-15	
	KFD2-CD-Ex1.32-2	
	KFD2-CD-Ex1.32-8	
	KFD2-SCD2-Ex1.LK	
	KFD2-SCD2-Ex2.LK	
	KCD2-STC-1.20	
	KCD2-STC-1	Input 4 mA ... 20 mA Output 4 mA ... 20 mA
	KCD2-STC-Ex1.SP	
	KCD2-STC-1.SP	Input 4 mA ... 20 mA Output 4 mA ... 20 mA
	KCD2-SCD-1	
	KCD2-SCD-1.SP	
	KCD2-SCD-Ex1.SP	
	KCD2-STC-Ex1	
	KCD2-SCD-Ex1	
	KFD2-SH-Ex1.T.OP	
	KCD2-SR-Ex1	
	KCD2-SCD-Ex1.ES.SP	
	KCD2-SR-1.LB	
	KCD2-SR-2	
	KCD2-SR-1.LB.SP	

Release date: 2021-04-08 Date of issue: 2021-04-08 Filename: 119265_eng.pdf

Refer to "General Notes Relating to Pepperl+Fuchs Product Information".

Matching System Components

	KCD2-SR-2.SP
	KCD2-SR-Ex1.LB
	KFD2-SH-Ex1.T
	KCD2-SLD-Ex1.1065
	KCD2-SLD-Ex1.1245
	KCD2-STC-Ex1.ES
	KCD2-STC-Ex1.ES.SP
	KFD2-RSH-1.2D.FL2-Y1
	KFD2-RSH-1.2D.FL3-Y1
	KFD2-RSH-1.2E.L2-Y1
	KFD2-RSH-1.2E.L3-Y1

Release date: 2021-04-08 Date of issue: 2021-04-08 Filename: 119265_eng.pdf

Refer to "General Notes Relating to Pepperl+Fuchs Product Information".

Pepperl+Fuchs Group
www.pepperl-fuchs.com

USA: +1 330 486 0002
pa-info@us.pepperl-fuchs.com

Germany: +49 621 776 2222
pa-info@de.pepperl-fuchs.com

Singapore: +65 6779 9091
pa-info@sg.pepperl-fuchs.com

Safety Information



Cover empty, open segments of the Power Rail. Use the supplied cover. Thereby Power Rail will be protected from pollution. The contact with electrically conductive parts on Power Rail will be prevented.